

RoHS
Ready 

Industrie-Steckverbinder Heavy Duty Connectors



TE CONNECTIVITY TECHNOLOGY PORTFOLIO



● Connector Systems /
Electromechanical Components

● Relays

● Wireless Products

● Sensors

● Fiber Optic Products

● Wire & Cable

● Application Tooling

● Antennas, GPS Antennas,
Integrated Antenna Systems

● Circuit Protection Devices

● Tubing & Harnessing Products

● Touch Screen Displays

● Power Systems

● Electronic Modules

● Resistors & Inductors

● Battery Connectors &
Assemblies

● Heat Sinks & Thermal Solutions

● Switches and Knobs

● Identification Labeling Products

● Racks & Panels

● Smart Cards / Leadframes



TE Connectivity Online

The TE Connectivity website is an innovative and interactive source for application information, product updates and technical solutions.

Our step-by-step software makes our website intuitive and user-friendly to better serve you!

Please contact us at:

te.com

Product Information Centers

You've got questions? TE's Product Information Centers (PIC) will help you get answers.

Contact a technical product information specialist.

- Email us
- Call us
- Chat with us

Please go to te.com/help for more information.

Internet

te.com/products/HTS

Restriction on the Use of Hazardous Substances (RoHS)

At TE Connectivity (TE), we're ready to support your RoHS requirements. We've assessed more than 1.5 million end items/components for RoHS compliance, and issued new part numbers where any change was required to eliminate the restricted materials. Part numbers in this catalog are identified as:

RoHS Compliant

Part numbers in this catalog are RoHS Compliant, unless marked otherwise.

These products comply with European Union Directive 2002/95/EC as amended 1 January 2006 that restricts the use of lead, mercury, cadmium, hexavalent chromium, PBB, and PBDE in certain electrical and electronic products sold into the EU as of 1 July 2006.

Note: For purposes of this Catalog, included within the definition of RoHS Compliant are products that are clearly "Out of Scope" of the RoHS Directive such as hand tools and other non-electrical accessories.

Non-RoHS Compliant

These part numbers are identified with a "◆" symbol. These products do not comply with the material restrictions of the European Union Directive 2002/95/EC.

5 of 6 Compliant

A "●" symbol identifies these part numbers. These products do not fully comply with the European Union Directive 2002/95/EC because they contain lead in solderable interfaces (they do not contain any of the other five restricted substances above allowable limits). However, these products may be suitable for use in RoHS applications where there is an application-based exemption for lead in solders, such as the server, storage, or networking infrastructure exemption.

Note: Information regarding RoHS compliance is provided based on reasonable inquiry of our suppliers and represents our current actual knowledge based on the information provided by our suppliers. This information is subject to change. For latest compliance status, refer to our website referenced below.

Getting the Information You Need

Our comprehensive on-line RoHS Customer Support Center provides a forum to answer your questions and support your RoHS needs. A RoHS FAQ (Frequently Asked Questions) is available with links to more detailed information. You can also submit RoHS questions and receive a response within 24 hours during a normal work week. The Support Center also provides:

- Cross-Reference from Non-compliant to Compliant Products
- Ability to browse RoHS Compliant Products in our on-line catalog: te.com/customersupport/productcompliance
- More detailed information regarding the definitions used above

So whatever your questions when it comes to RoHS, we've got the answers at www.te.com/leadfree

RoHS
Customer
Support
Center 

Inhalt/Contents

			Seite/Page
Produkt-Übersicht/Product overview			4 – 9
Technische Hinweise/Technical information			10 – 27
Anschlussarten/Termination types			28 – 31
Crimpkontakte und Werkzeuge/Crimp contacts and tools			32 – 44
Kontakteinsätze/Contact inserts	Gehäuse-Serien/Housing series	Baugröße/Size	
HA.3, HA.4, HE-Q.5, HD.7, HN.D.7		1	45 – 48
	HA.3, HG-Q.5, EMV.3/4, HIP-K.3/4	1	49 – 54
HG-Q 4+2, HG-Q 8, HG-Q 10	HG-Q, HG-Q.EMV	0	55
		0	56 – 58
HA.10, HD.15, HN.D.15	HA.10, HD.15	2	60 – 62
		2	63 – 65
HE.6, HEE.10, HVT.8, HD.16, HN.2D.24, HSK 4+2	HB.6, HB-KF.6, HD.16, EMV-K.6/16, HIP-K.6/16	3	66 – 72
		3	73 – 80
HE.10, HEE.18, HVT.14, HD.24, HN.2D.42, HMX 8/24	HB.10, HB-KF.10, HD.24, EMV-K.10/24, HIP-K.10/24	4	81 – 86
		4	87 – 99
HA.16, HD.25, HN.D.25	HA.16, HD.25	5	100 – 102
		5	103 – 105
HSB.6/35, HE.16, HEE.32, HVT.23, HD.40, HN.D.40, HSK.6+36, HN.2D.72, HMX 6/12, HMX 12/2, HMX 4/0, HMX 4/1	HB.16, HB-KF.16, HD.40, EMV-K.16/40, HIP-K.16/40	6	106 – 114
		6	115 – 126
HA.32, 2xHN.D.25, 2xHD.25	HA.32	7	127 – 129
		7	130 – 131
HSS.8+2, HMX.4/8, HE.24, HEE.46, HVT.35, HVT.48, HD.64, HN.D.64, HN.2D.108	HB.24, HB-KF.24, HD.64, HD-KF.64, HD.108, EMV-K.24/64, EMV-KF/K.64, HI-KP.24/64, HIP-KF.24/64	8	132 – 138
		8	139 – 151
HA.48	HA.48	9	152
		9	153 – 154
HSB.12/35, HE.32, HD.80, HN.D.80, HN.2D.144	HB.32	10	155 – 159
		10	160 – 165
HA.64	HA.64	11	166
		11	167
HE.48, HD.128, HN.D.128, HN.2D.216, HEE 92	HB.48	12	168 – 171
		12	172 – 174
HF-Serie/HF series			175 – 176
Schutzkontakt-Serie/Schutzkontakt series			177
Quick-In-System/Quick-In-System			178
Schirmzubehör/Accessories for braided/shielded applications			181 – 183
Schutzhauben/Cover			184 – 185
Adapterbleche/Adapter plates			186 – 187
Kabelverschraubungen/Cable fittings			188 – 193
Modul System MDL/Module System MDL			194 – 203
Modul System HVS/Module System HVS			204 – 213
Bestellnummern mit Seitenangabe/Ordering Numbers with pages			214 – 228

Gehäuse/Housings

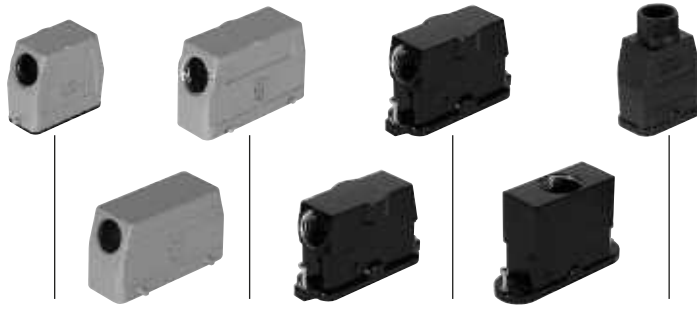

Kontakteinsätze/Contact Inserts

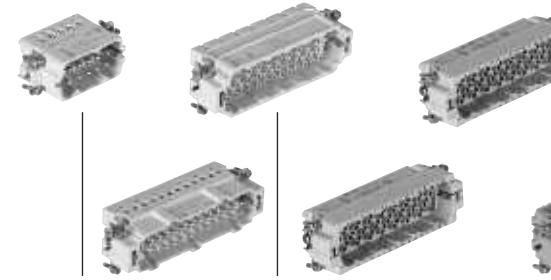

Serie Series	HA	HB	HD	HIP-K	EMV-K	HF	HG Q
Merkmale Schmale Standard Serie	Breite Standard Serie	Hohe Standard Serie	Druckdicht Korrosionsgeschützt	Störspannungssicher Druckdicht Korrosionsgeschützt	Störspannungssicher Druckdicht Korrosionsgeschützt	Kunststoff	
Features <i>thin standard Series</i>	<i>wide standard series</i>	<i>High standard Series</i>	<i>pressure tight Corrosion protected</i>	<i>EMC Dense and pressure tight Corrosion protected</i>	<i>EMC Dense and pressure tight Corrosion protected</i>	<i>plastic</i>	
IP	44 - 65	65	65	68	68	68	65
Verriegelung Locking system	VS LB	VS LB ZB	VS LB ZB	SV	SV	SV	LB
				VS = 2 Verschlussbüge / 2 lever locking LB = 1 Längsbügel / 1 locking lever ZB = 1 Zentralbügel / 1 central locking SV = 2 Schrauben / 2 Screws			
Baugröße Size	Seite Page	Seite Page	Seite Page	Seite Page	Seite Page	Seite Page	Seite Page
1	49-50			53-54	53-54		51-52
Q							56-58
2	63-65		63-65				
3		73-78	73-78	79-80	79-80		
4		87-97	87-97	98-99	98-99		
5	103-105		103-105				
6		114-124	115-124	125-126	125-126		
7	130-131						
8		139-149	139-149	150-151	150-151	176	
9	153-154						
10		160-165					
11	167						
12		172-174				176	

Serie Series	HA	HE	HEE	HD	HN.D
Elektr. Kennwerte nach VDE Last/Signal Rating according VDE Power/signal	250V 10A (size 1) 16A	400V 16A	500V 16A	250V 10A	250V 10A
Verschmutzungsgrad Degree of pollution	3	3	3	3	3
Anschlussart Type of terminals	Crimp/Screw/Spring	Crimp / Screw / Spring	Crimp	Crimp (stamped)	Crimp
Weitere Normen Additional standards	DIN VDE 0627 EN 61984	DIN VDE 0627 EN61984	DIN VDE 0627 EN61984	DIN VDE 0627 EN 61984 DIN EN 175.301-801	DIN VDE 0627 EN 61984 DIN EN 175.301-801
Baugröße Size	Pole Pos. Seite Page	Pole Pos. Seite Page	Pole Pos. Seite Page	Pole Pos. Seite Page	Pole Pos. Seite Page
1	3 4 45	5 46		7 8 48	7 8 47
Q					
2	10 60			15 62	15 61
3		6 66	10 67	16 69	
4		10 81	18 82	24 84	
5	16 100			25 102	25 101
6		16 106	32 107	40 110	40 109
7	32 127			50 129	50 128
8		24 132	46 133	64 136	64 135
9	48 152				
10		32 155		80 158	80 157
11	64 166				
12		48 168	92 170	128 170	128 169

4 Verbindlich für Toleranzen der Abmessungen und technische Werte sind ausschließlich die neuesten TE Connectivity Kundenzeichnungen bzw. Produkt-Spezifikationen, die Sie auf Anfrage erhalten. All specifications subject to change. Consult TE Connectivity for latest design specifications.

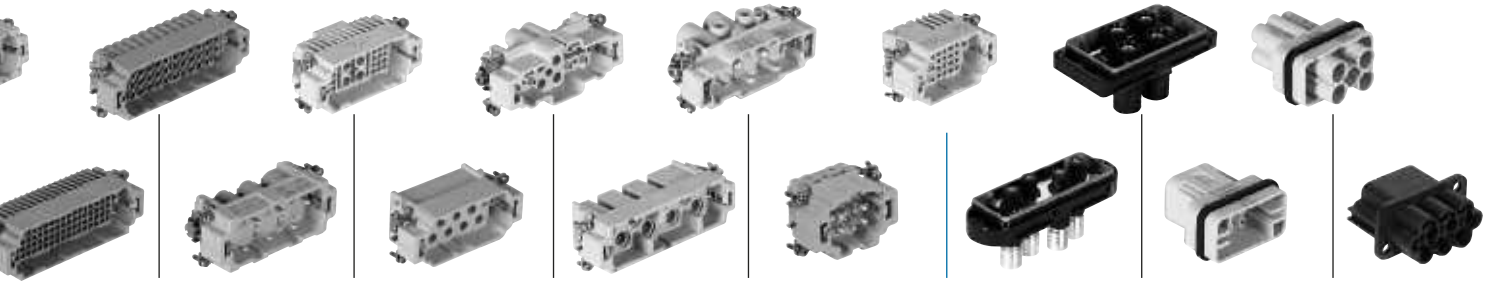

HN.2D	HVT	HSB	HSK 6/36	HMX 12/2	HMX 6/12	HSS	HMX (4/0, 4/2)	HSK 4/2	HMX 8/24	HF 8	HF 13	HG-Q8	HG-Q4+2	HG-Q10			
250V 10A	400V 16A	400V 35A	690V/ 250V 40A/10A	500V/ 250V 40A/10A	690V/ 400V 40A/10A	600V/ 400V 63A/16A	690V 400V 80A/16A	500V/ 400V 40A/16A	400V/ 250V 16A/10A	1000V 250A	3000V 350A	500V 16A	690V 40A	400V 20A			
3	3	3	3	3	3	3	3	3	3	3	3						
Crimp	Crimp	Screw	Crimp	Crimp	Crimp	Crimp	Screw	Screw	Crimp	Crimp	Crimp	Crimp	Crimp	Crimp			
DIN VDE 0627 EN 61984	DIN VDE 0627 EN 61984	DIN VDE 0627 EN 61984	DIN VDE 0627 EN 61984	DIN VDE 0627 EN 61984	DIN VDE 0627 EN 61984	DIN VDE 0627 EN 61984	DIN VDE 0627 EN 61984	DIN VDE 0627 EN 61984	DIN VDE 0627 EN 61984	DIN VDE 0627 EN 61984	DIN VDE 0627 EN 61984	ISO 23570-3	ISO 23570-3	DIN VDE 0627 EN 61984			
Pole Pos.	Seite Page	Pole Pos.	Seite Page	Pole Pos.	Seite Page	Pole Pos.	Seite Page	Pole Pos.	Seite Page	Pole Pos.	Seite Page	Pole Pos.	Seite Page	Pole Pos.	Seite Page		
												8	55	4/2	55	10	55
24	70	8	68					4/2	71	8/24	85						
42	85	14	83														
72	109	23	108	6	113	6/36	111	12/2	112	6/12	112						
								4/0	113	4/2							
108	135	35	134					8/2	137	4/8	137						
												4	175	4	175		
144	157			12	156												
216	169																

Verbindlich für Toleranzen der Abmessungen und technische Werte sind ausschließlich die neuesten TE Connectivity Kundenzeichnungen bzw. Produkt-Spezifikationen, die Sie auf Anfrage erhalten.
 All specifications subject to change. Consult TE Connectivity for latest design specifications.

Gehäuse/Housings

Kontakteinsätze/Contact Inserts

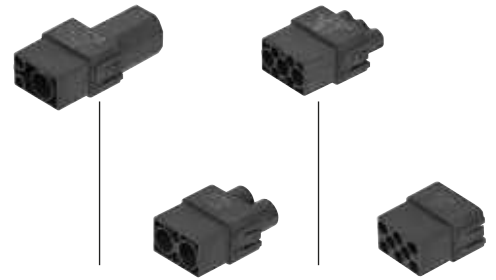
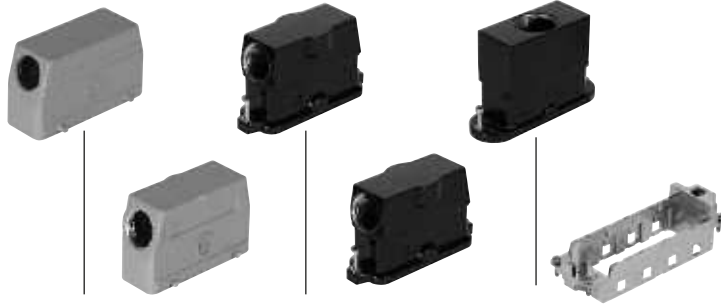

Serie Series	HB	HD	HIP-K	EMV-K	HF	Rahmen Frame	Serie Series	MDL. 1+2	MDL. 2+2	MDL. 3+4	MDL. 8	
Merkmale	Breite Standard Serie	Hohe Standard Serie	Druckdicht Korrosions-geschützt	Störspannungssicher Druckdicht Korrosions-geschützt	Störspannungssicher Druckdicht		Elektr. Kennwerte nach VDE Last/Signal Rating according VDE Power/signal	1000V/250V 150A/10A	1000V/250V 63A/10A	1000V/250V 40A/10A	400V 16A	
Features	wide standard series	High standard Series	pressure tight Corrosion protected	EMC Dense and pressure tight Corrosion protected	EMC Dense and pressure tight Corrosion protected		Polzahl Poles	1+ 2	2+ 2	3+ 4	8	
IP	65	65	68	68	68		Verschmutzungsgrad Degree of pollution	3	3	3	3	
Verriegelung Locking system	VS LB ZB	VS LB ZB	SV	SV	SV		Anschlussart Type of terminals	Crimp	Crimp	Crimp	Crimp	
	VS = 2 Verschlussbüge /2 lever locking LB = 1 Längsbügel/1 locking lever ZB = 1 Zentralbügel/1 central locking SV = 2 Schrauben/2 Screws							Weitere Normen Additional standards	DIN VDE 0627 EN 61984	DIN VDE 0627 EN 61984	DIN VDE 0627 EN 61984 DIN EN 175.301-801	DIN VDE 0627 EN 61984
Baugröße Size	Seite Page	Seite Page	Seite Page	Seite Page	Seite Page	Seite Page	Seite Page	194	194	195	195	
3	73-78	73-78	78-80	78-80		72 + 201						
4	87-90	87-97	98-99	98-99		86 + 201						
6	114-124	115-124	125-126	125-126		114 + 202						
8	139-149	139-149	150-151	150-151	176	138 + 202						
10	160-165					159 + 203						
12	172-174				176	171 + 203						

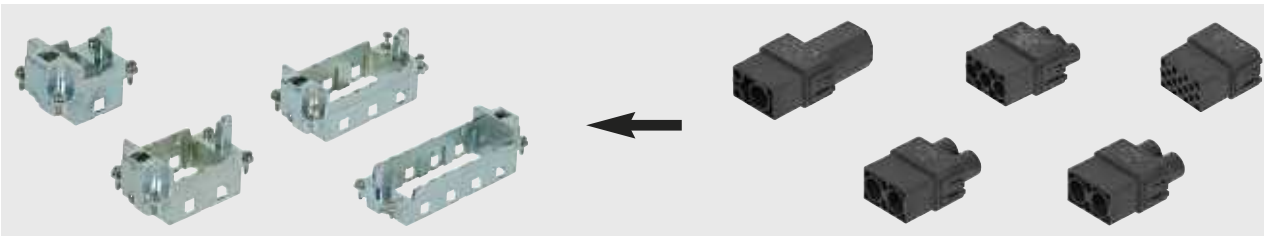

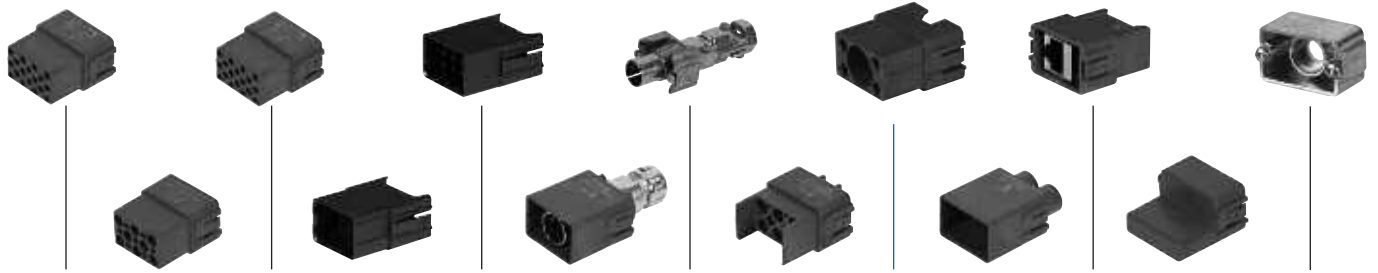

MDL. HD.18	MDL. HN.D.15	MDL. HN.D.18	Dynamic D-2800	Dynamic D-3800	MDL. TX.4	MDL. E.TWIN	MDL. KX	VT coax	MDL.2. AIR.Sti	MDL. RJ45	MDL.2 Blindmodul	MDLEC Erdmodul
250V 10A	400V 10A	400V 10A	250V 5A	600V 8A	150V 16A Twisted pair	150V 16A	RG 58 RG 59	75 Ohm Inner/Outer diam. 0,8/6,1 1,44/10 2,8/10,7	10 bar	Cat5e		
Fiber optic												
18	15	18	30	12	4	4	6	1	2	1 Plug/Jack		
3	3	3	3	3	3	3	3	3	3			
Crimp (stamped) Melting (fiber)	Crimp	Crimp	Crimp	Crimp	Crimp	Crimp	Crimp	solder	push	IDC Patch cable		Crimp
DIN VDE 0627 EN 61984	DIN VDE 0627 EN 61984	DIN VDE 0627 EN 61984	DIN VDE 0627 EN 61984		DIN VDE 0627 EN 61984	DIN VDE 0627 EN 61984						
196	196	196	197	197	198	198	198	199	200	199	200	200



Gehäuse/Hoods

Kontakteinsätze/Contact Inserts

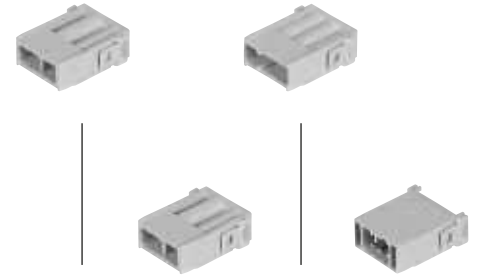

Serie Series	HB	HD	HIP-K	EMV-K	HF	Rahmen Frame	Serie Series	HSS.2	HSK.2	HSK.3	HE 5 SC	
Merkmale	Breite Standard Serie	Hohe Standard Serie	Druckdicht Korrosions-geschützt	Störspannungssicher Druckdicht Korrosions-geschützt	Störspannungssicher Druckdicht		Elektr. Kennwerte nach VDE Last/Signal Rating according VDE Power/signal	500V/63A	1000V/40A	690V/40A	400V/16A	
Features	wide standard series	High standard Series	pressure tight Corrosion protected	EMC Dense and pressure tight Corrosion protected	EMC Dense and pressure tight Corrosion protected		Polzahl Poles	2	2	3	5	
IP	65	65	68	68	68		Verschmutzungsgrad Degree of pollution	3	3	3	3	
Verriegelung Locking system	VS LB ZB	VS LB ZB	SV	SV	SV		Anschlussart Type of terminals	Crimp	Crimp	Crimp	Spring Clamp	
	VS = 2 Verschlussbüge /2 lever locking LB = 1 Längsbügel/1 locking lever ZB = 1 Zentralbügel/1 central locking SV = 2 Schrauben/2 Screws							Weitere Normen Additional standards	DIN VDE 0627 EN 61984	DIN VDE 0627 EN 61984	DIN VDE 0627 EN 61984	DIN VDE 0627 EN 61984
Baugröße Size	Seite Page	Seite Page	Seite Page	Seite Page	Seite Page	Seite Page	Seite Page	204	204	205	205	
3	73-78	73-78	78-80	78-80								
4	87-90	87-97	98-99	98-99								
6	114-124	115-124	125-126	125-126								
8	139-149	139-149	150-151	150-151	176							
10	160-165											
12	172-174				176							

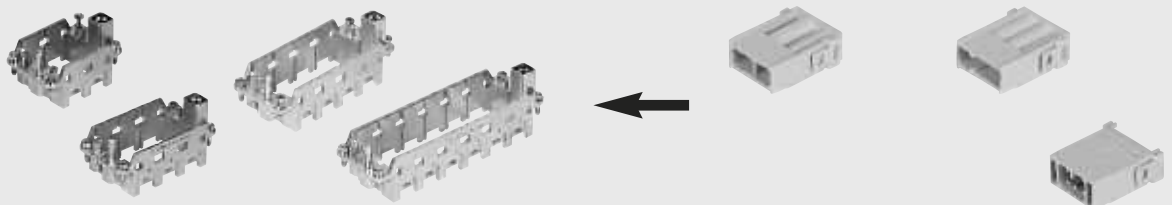

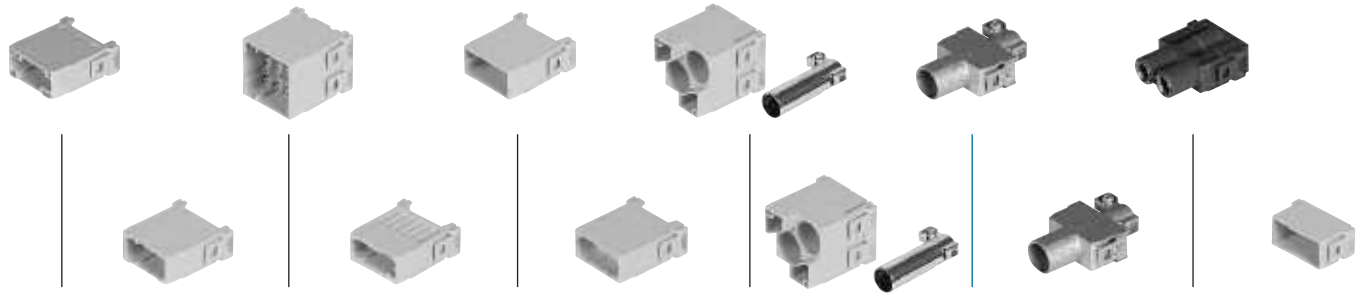

HE 6	HE 8	HE 20	HN.D 12	HN.D 17	S20.DF25	TX HN.D	TX S20DF	TX.MVB HN.D	TX.MVB S20DF	Pneumatik	Blindmodul
500V/16A	400V/16A	500V/16A	250V/10A	250V/10A	50V/5A	50V/10A	50V/5A	50V/10A	50V/5A	10 Bar	
6	20	18	12	17	25	2x4	2x8	4	8	2	
3	3	3	3	3	3	3	3	3	3		
Crimp	Crimp	Crimp	Crimp	Crimp	Crimp	Crimp	Crimp	Crimp	Crimp		
DIN VDE 0627 EN 61984	DIN VDE 0627 EN 61984	DIN VDE 0627 EN 61984	DIN VDE 0627 EN 61984	DIN VDE 0627 EN 61984	DIN VDE 0627 EN 61984	DIN VDE 0627 EN 61984	DIN VDE 0627 EN 61984	DIN VDE 0627 EN 61984	DIN VDE 0627 EN 61984		
206	206	207	207	208	209	209	209	210	210	210	211

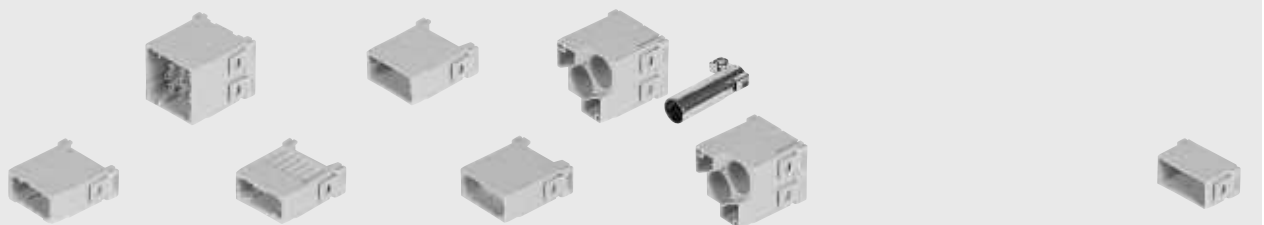

Steckverbinder Bauteilkomponenten/Connector components

Kabel-Verschraubung

Spezial-Kabelverschraubungen für Schutzarten bis IP 68 und für EMV-Anwendung lieferbar

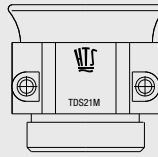

Cable fitting

Special cable fittings for protection up to IP 68 and for electro-magnetic compatibility available

Gehäuse-Oberteil

Standard- und korrosionsgeschützte Stecker Gehäuse

- in niedriger oder hoher Bauform
- 4 unterschiedliche Verriegelungssysteme
- unterschiedliche Kabeleingänge: Panzergewinde (PG) metrische Gewinde (M) NPT-Gewinde (NPT)

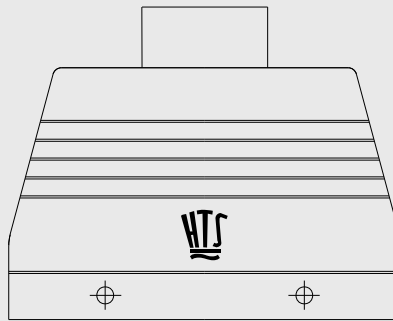

Hood

Standard and corrosion-resistant connector hoods:

- low and high construction
- 4 different locking systems
- different cable entries: PG Thread M Thread NPT Thread

Kontakte

Silber- oder Goldoberfläche Gedrehte Massivkontakte mit Schraub, Feder oder Crimp-Anschluss

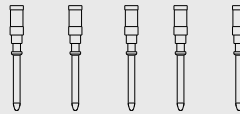

Contacts

Silver or gold plated Solid machined contacts with screw, spring or crimp termination

Stift-Einsatz

Schraub-, Spring Clamp-, oder Crimp-Anschluss

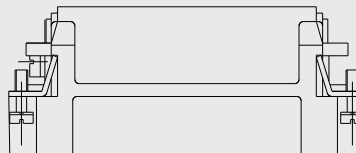

Male insert

Screw, Spring clamp or crimp terminal

Buchsen-Einsatz

Schraub-, Spring Clamp-, oder Crimp-Anschluss



Female insert

Screw, Spring clamp or crimp terminal

Gehäuse-Unterteil

Standard- und korrosionsgeschützte Anbau-, Sockel-, und Kupplungs-Gehäuse

- Niedrige oder hohe Bauform der Sockel- und Kupplungs-Gehäuse, ohne/mit komplett montiertem Aludeckel
- 4 unterschiedliche Verriegelungssysteme

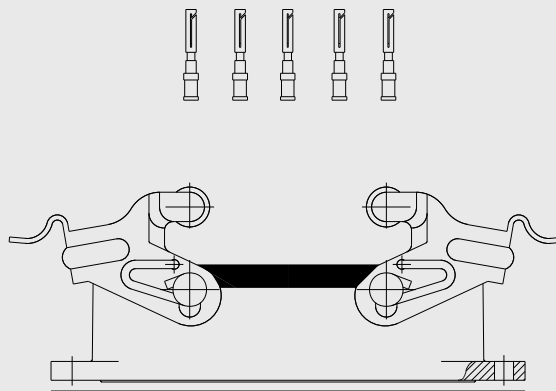

Hood and housing

Standard and corrosion-resistant bottom-entry, surface-mounted and cable-to-cable hoods:

- low and high construction (bottom-entry and cable-to-cable hood) with/without aluminium cover
- 4 different locking systems

Approvals/Zulassungen							
Series	VDE	SEV	UL	CSA	Germanischer Lloyd	Application Specification	Product Specification
○ = in Vorbereitung/in process							
HA 3/4	•	•	•	•		114-74010	108-74008
HA 10/16	•	•	•	•		114-74056	108-74055
HB 6-24			•			114-74009	108-74007
						114-74003	108-18215
HE Q5	○	•	○	○		114-74008	108-74004
						114-74003	108-74064
HE 6-24	•	•	•	•	•	114-74008	108-74004
HEE 10-46	•	•	○	○		114-74003	108-74005
						114-74008	108-18215
HD/HN.D 7	•	•	•	•		114-74000	
HN.D 8	•	•	•	•		114-74015	108-74002
						114-74000	
HD/HN.D 15/25	•	•	•	•		114-74015	108-74018
HD 16/24	•	•	•	•		114-74000	108-74002
						114-74015	108-74018
HD/HN.D 40-64	•	•	•	•		114-74000	108-74002
HVT 8-23+48	•	•				114-74002	108-74002
						114-74015	108-74018
HVT 35	•	•	○	○		114-74026	108-74035
						114-74013	
HN.2D 24-108	•	•	•	•		114-74013	108-74035
HSB 6	•	•	•	•		114-74012	108-74012
HSS 8	•	•	•	•		114-74007	108-74006
MDL 1+2			•	•		114-74028	108-74016
MDL 3+4			•	•		114-74031	108-74024
MDL 2+2			•	•		114-74036	108-74017
MDL HN.D 15 & MDL HN.D 18			•	•			108-74031
MDL HD 15 & MDL HD 18			•	•		114-74000	108-74000
						114-74015	108-74032
MDL Air Pneumatic			•	•		114-74014	108-74033
MDL Twinax			•	•		114-74020	108-74013
						114-74044	
MDL Koax			•	•		114-74033	
						114-74034	
MDL HVT 8			•	•		114-74013	108-74034
HVS	○		○	○		○	○
HSK 6/36	○		○	○		114-74062	
HMX 4/2; HMX 4/0	○		○	○		114-74058	108-74058
HMX 8/24	○		○	○		114-74061	108-74060
HMX 6/12	○		○	○		114-74051	108-74051
HMX 4/8	○		○	○		114-74067	108-74065
HMX 12/2	○		○	○		114-74068	108-74066
HSK 4/2	○		○	○		114-74063	108-74061
HF13			○	○		114-74032	108-74044
HF8			○	○		114-74043	108-74044
HMX 8/24			○	○		114-74061	
HG-Q8	○		○	○		114-74050	108-74050
HG-Q4+2	○		○	○		114-74055	108-74053
						114-74062	
HG-Q10	○		○	○		114-74065	

HA 3/4						114-74002	
HA						114-74010	108-74000
						114-74001	108-74009
Quick in Adapter HB						114-74004	108-74026
						114-74024	
HM.10						114-74001	108-74001
						114-74004	108-74003
HD						114-74014	108-74014
						114-74004	108-74027
HIP-K						114-74001	108-74041
						114-74004	108-74001
EMV-K						114-74003	108-74003
						114-74004	108-74027
HF						114-74030	108-74030
						114-74036	108-74036
HG Q						114-74035	
						114-74036	
						114-74064	
						114-74065	108-74052

Schutzarten von elektrischen Betriebsmitteln

Elektrische Betriebsmittel müssen aus Sicherheitsgründen gegen Einflüsse von außen geschützt werden. Diese Aufgabe übernehmen Gehäuse, die das elektrische Betriebsmittel gegen Berührung, das Eindringen von festen Fremdkörpern, Staub, Feuchtigkeit oder Wasser schützen. Die Norm IEC 529 mit dem Titel „Schutzarten durch Gehäuse (IP-Code)“ bildet die Grundlage für die Bestimmung und Kennzeichnung der Schutzart eines Gehäuses

Der Umfang der Schutzes (Schutzart) durch ein Gehäuse wird mittels genormter Prüfverfahren nachgewiesen. Zur Einteilung verschiedener Gehäuse bezüglich ihrer Schutzart wird ein Bezeichnungssystem verwendet. Das Bezeichnungssystem besteht aus den Code-Buchstaben IP und zwei nachfolgenden Kennziffern.

Zusammensetzung des IP – Code (International bzw. Ingress Protection)

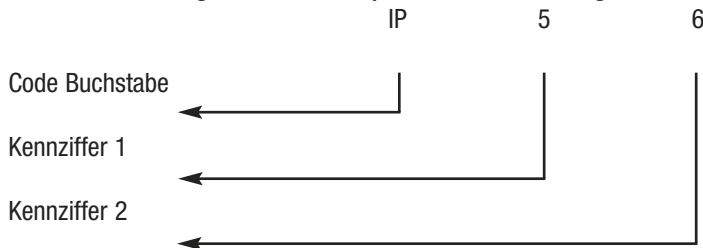

Die erste Kennziffer gibt den Berührungs- und Fremdkörperschutz, die zweite den Schutz des Gehäuses gegen das Eindringen von Wasser an. Die folgende Tabelle enthalten Kurzbeschreibung sowie Definitionen der einzelnen Kennziffern des IP-Codes.

Bedeutung der ersten Kennziffer

Die erste Kennziffer gibt an, inwieweit das Gehäuse Personenschutz gewährleistet. Dieser Schutz wird erreicht, indem das Eindringen eines Körperteils (oder eines Gegenstandes der von einer Person gehalten wird) in das Gehäuse verhindert wird. Gleichzeitig gewährt das Gehäuse dem Betriebsmittel Schutz gegen das Eindringen von festen Fremdkörpern. Dies ist der Grund dafür, dass es zu jeder ersten Kennziffer 2 Beschreibungen und 2 Definitionen gibt.

Erste Kennziffer	Schutzgrad gegen Zugang von gefährlichen Teilen und gegen feste Fremdkörper	
	Kurzbeschreibung	Definition
0	Nicht geschützt	
1	-Geschützt gegen feste Fremdkörper mit Ø 50mm -Geschützt gegen den Zugang zu gefährlichen Teilen mit dem Handrücken.	Kugel mit Ø 50mm darf nicht voll eindringen
2	-Geschützt gegen feste Fremdkörper 12,5 mm Durchmesser -Geschützt gegen den Zugang zu gefährlichen Teilen mit einem Finger	Prüffinger mit Ø 12mm muss ausreichend Abstand von gefährlichen Teilen haben.
3	-Geschützt gegen feste Fremdkörper Ø 2,5mm -Geschützt gegen den Zugang zu gefährlichen Teilen mit einem Werkzeug	Prüfsonde mit Ø 2,5mm Durchmesser darf nicht eindringen.
4	-Geschützt gegen feste Fremdkörper Ø 1,0mm Durchmesser. -Geschützt gegen den Zugang zu gefährlichen Teilen mit einem Draht	Prüfsonde mit Ø 1mm Durchmesser darf nicht eindringen.
5	Staubgeschützt	Eindringen von Staub wird nur soweit verhindert, dass dieser das zufriedenstellende Arbeiten des Gerätes oder die Sicherheit nicht beeinträchtigt.
6	Staubdicht	Kein Eindringen von Staub.

Bedeutung der zweiten Kennziffer

Die zweite Kennziffer gibt an, inwieweit das Gehäuse schädliche Einflüsse auf das Betriebsmittel infolge des Eindringens von Wasser verhindert.

Zweite Kennziffer	Schutz gegen Wasser	
	Kurzbeschreibung	Definition
0	Nicht geschützt	
1	Geschützt gegen Tropfwasser	Senkrecht fallende Tropfen dürfen keine schädliche Wirkung haben
2	Geschützt gegen Tropfwasser, wenn das Gehäuse bis zu 15° geneigt ist.	Senkrecht fallende Tropfen dürfen keine schädliche Wirkung haben, wenn das Gehäuse um einen Winkel bis zu 15° beiderseits der Senkrechten geneigt ist.
3	Geschützt gegen Sprühwasser.	Wasser, das in einem Winkel bis zu 60° beiderseits der Senkrechten gesprüht wird, darf keine schädliche Wirkung haben.
4	Geschützt gegen Spritzwasser.	Wasser, das aus jeder Richtung gegen das Gehäuse spritzt, darf keine schädliche Wirkung haben.
4K	Geschützt gegen Spritzwasser mit erhöhtem Druck.	Wasser, das aus jeder Richtung mit erhöhtem Druck gegen das Gehäuse spritzt, darf keine schädliche Wirkung haben. (gilt nach DIN 40 050 Teil 9 nur für Straßenfahrzeuge)
5	Geschützt gegen Strahlwasser.	Wasser, das aus jeder Richtung als Strahl gegen das Gehäuse spritzt, darf keine schädliche Wirkung haben.
6	Geschützt gegen starkes Strahlwasser.	Wasser, das aus jeder Richtung als starker Strahl gegen das Gehäuse spritzt, darf keine schädliche Wirkung haben.
6K	Geschützt gegen starkes Strahlwasser mit erhöhtem Druck.	Wasser, das aus jeder Richtung als Strahl mit erhöhtem Druck gegen das Gehäuse gerichtet ist, darf keine schädliche Wirkung haben. (gilt nach DIN 40050 Teil 9 nur für Straßenfahrzeuge)
7	Geschützt gegen die Wirkung beim zeitweiligen Untertauchen in Wasser.	Wasser darf nicht in einer Menge eintreten, die schädliche Wirkung verursacht, wenn das Gehäuse unter genormten Druck- und Zeitbedingungen zeitweilig in Wasser untergetaucht ist
8	Geschützt gegen die Wirkung beim dauernden Untertauchen in Wasser.	Wasser darf nicht in einer Menge eintreten, die schädliche Wirkung verursacht, wenn das Gehäuse dauernd unter Wasser getaucht ist unter Bedingungen, die zwischen Hersteller und Anwender vereinbart werden müssen. Die Bedingungen müssen jedoch schwieriger sein als für die Kennziffer 7.
9K	Geschützt gegen Wasser bei Hochdruck-/Dampfstrahlreinigung.	Wasser, das aus jeder Richtung unter stark erhöhtem Druck gegen das Gehäuse gerichtet ist, darf keine schädliche Wirkung haben. (gilt nach DIN 40 050 Teil 9 nur für Straßenfahrzeuge)

Isolationskoordination für elektrische Betriebsmittel in Niederspannungsanlagen

Bemessung der Luft- und Kriechstrecken nach DIN EN60664-1. (Die folgenden Seiten stellen lediglich einen Auszug der Norm dar und zeigen nicht den vollständigen Inhalt)

Isolationskoordination

Isolationskoordination umfasst die Auslegung der elektrischen Isolation eines Betriebsmittels hinsichtlich dessen Anwendung und Umgebung.

Dies geschieht einerseits durch Auslegung der Luftstrecken (Basis ist dabei die zu erwartende Überspannung), andererseits durch Auslegung der Kriechstrecken (Basis sind dafür die Betriebsspannungen sowie die Isolierstoffeigenschaften). Weiter werden isolationseigenschaft-verändernde Bedingungen berücksichtigt (Verschmutzung, Schutzmaßnahmen gegen Verschmutzung, Luftdruck, thermische oder chemische Beeinflussung).

Luftstrecken werden nach der äußeren oder inneren zu erwartenden Überspannungen bemessen. Die 4 Überspannungsklassen (Überspannungskategorien I bis IV) berücksichtigen die unterschiedliche Verwendung eines Betriebsmittels. Die für die jeweilige Nennspannung des Versorgungsnetzes unterschiedliche Bemessungs-Stoßspannungen ist hierbei die Grundlage.

Je nach Homogenitätsgrad des Feldes zwischen den Elektroden (Fall A – inhomogenes Feld, Fall B – homogenes Feld) können die Luftstrecken aus Tabelle 2a (Mindestluftstrecken) bestimmt werden; Industriesteckverbinder werden immer nach dem „Fall A“ ausgelegt. Der Einfluss durch Verschmutzung wird bei der Festlegung von Luft- und Kriechstrecken durch vier Schärfegrade (Verschmutzungsgrad 1 bis 4) berücksichtigt.

Grundlage der **Kriechstrecken** ist die aus der Betriebsspannung abgeleitete Bemessungsspannung.

Die Mindestkriechstrecken sind in Tabelle 4 den Bemessungsspannungen je nach Verschmutzungsgrad zugeordnet.

Enthalten die Produktbeschreibungen keine zusätzlichen Angaben, sind die in diesem Katalog aufgeführten Produkte nach dieser Bestimmung (DIN EN60664-1) für Überspannungskategorie III und Verschmutzungsgrad 3 bemessen.

Überspannungskategorie I bis IV

- Betriebsmittel der **Überspannungskategorie I** sind Waren zum Anschluss an die feste elektrische Installation eines Gebäudes. Es ist entweder in der festen Installation oder zwischen der festen Installation und dem Gerät, Maßnahmen zur Begrenzung der transienten Überspannungen getroffen worden.
- Betriebsmittel der **Überspannungskategorie II** sind energieverbrauchende Betriebsmittel, die von der festen Installation gespeist werden.
Anmerkung: z. B. Haushaltsgeräte, tragbare Werkzeuge und andere Hausgeräte sowie ähnliche Verbraucher.
- Betriebsmittel der **Überspannungskategorie III** sind Bestandteil der festen Installation. Es sind Betriebsmittel, bei denen ein höherer Grad der Verfügbarkeit erwartet wird.
Anmerkung: Beispiele für solche Geräte sind z.B. Industriesteckverbinder, Verteilertafeln, Leistungsschalter, Verteilungen, Schalter, Steckdosen).
- Geräte der **Überspannungskategorie IV** sind für den Einsatz am Anschlusspunkt der Installation bestimmt.
Anmerkung: Beispiele für solche Geräte sind Elektrizitätszähler, Überstromschutzschalter und Rundsteuergeräte.

Verschmutzungsgrad 1 bis 4

In DIN EN60664-1 sind die Verschmutzungsgrade wie folgt definiert:

Verschmutzungsgrad 1:

Es tritt keine oder nur trockene, nicht leitfähige Verschmutzung auf. Die Verschmutzung hat keinen Einfluss.

Verschmutzungsgrad 2:

Es tritt nur nichtleitfähige Verschmutzung auf. Gelegentlich muss mit vorübergehender Leitfähigkeit durch Betauung gerechnet werden.

Verschmutzungsgrad 3:

Es tritt leitfähige Verschmutzung auf oder trockene, nichtleitfähige Verschmutzung, die leitfähig wird, da Betauung zu erwarten ist.

Verschmutzungsgrad 4:

Es tritt eine dauernde Leitfähigkeit auf, hervorgerufen durch leitfähigen Staub, Regen oder Nässe.

Isolierstoff

Die Isolierstoffe werden entsprechend ihren Vergleichszahlen der Kriechwegbildung (Comparativ Tracking Index) CTI in folgende vier Gruppen eingeteilt:

Isolierstoff I:	$600 \leq \text{CTI}$
Isolierstoff II:	$400 \leq \text{CTI} < 600$
Isolierstoff III a:	$175 \leq \text{CTI} < 400$

Bemessung der Luftstrecken

Schema zur Ermittlung der Luftstrecken

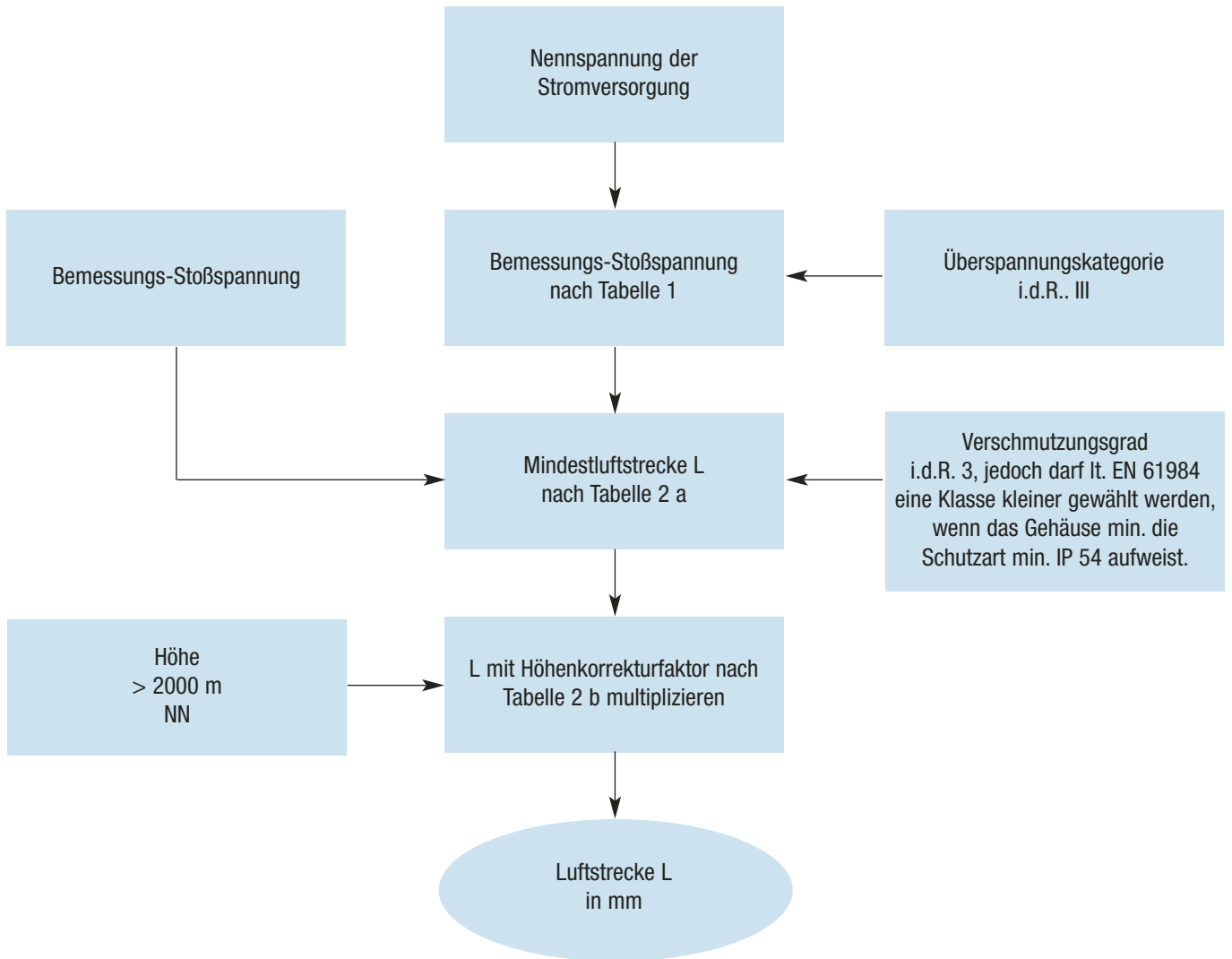

Bemessungs-Stoßspannung für Betriebsmittel (Tabelle 1)					
Nennspannung des Stromversorgungssystems *) in V		Bemessungs-Stoßspannung in kV (1,2/50ms) für			
Dreiphasige Systeme	Einphasige Systeme im Mittelpunkt	Betriebsmittel an der Einspeisung der Installation (Überspannungskategorie IV)	Betriebsmittel als Teil der festen Installation (Überspannungskategorie III)	Betriebsmittel zum Anschluss an die feste Installation (Überspannungskategorie II)	Besonders geschützte Betriebsmittel (Überspannungskategorie I)
	120 bis 240	4	2,5	1,5	0,8
230/400**		6	4	2,5	1,5
277/480**					
400/690**		8	6	4	2,5
1000		12	8	6	4

*) ausgewählte Spannungswerte

***) der / Strich bezeichnet ein Dreiphasen-Leitersystem. Der tiefere Wert ist die Spannung Leiter zu Neutralleiter, während der höhere Wert die Spannung Leiter zu Leiter ist

Mindestluftstrecken für die Isolationskoordination (Tabelle 2 a)

Erforderliche Steh- Stoßspannung 1) [kV]	Fall A (inhomogenes Feld) Verschmutzungsgrad				Fall B (homogenes Feld) Verschmutzungsgrad			
	1	2	3	4	1	2	3	4
	[mm]	[mm]	[mm]	[mm]	[mm]	[mm]	[mm]	[mm]
0,33 _)	0,01	_)	0,80	1,6	0,01	_)	0,8	1,6
0,40	0,02				0,02			
0,5 _)	0,04				0,04			
0,60	0,06				0,06			
0,80 _)	0,10				0,10			
1,0	0,15	0,25	0,80	1,6	0,15	0,2	0,8	1,6
1,2	0,25				0,2			
1,5 _)	0,5	0,5	1,0	1,6	0,3	0,3	0,8	1,6
2,0	1,0	1,0			0,45	0,5		
2,5 _)	1,5	1,5			0,6	0,6		
3,0	2	2	2	2	0,8	0,8	1,2	1,6
4,0 _)	3	3	3	3	1,2	1,2		
5,0	4	4	4	4	1,5	1,5	1,5	1,6
6,0 _)	5,5	5,5	5,5	5,5	2	2	2	
8,0 _)	8	8	8	8	3	3	3	3
10	11	11	11	11	3,5	3,5	3,5	3,5
12 _)	14	14	14	14	4,5	4,5	4,5	4,5
15	18	18	18	18	5,5	5,5	5,5	5,5
20	25	25	25	25	8	8	8	8
25	33	33	33	33	10	10	10	10
30	40	40	40	40	12,5	12,5	12,5	12,5
40	60	60	60	60	17	17	17	17
50	75	75	75	75	22	22	22	22
60	90	90	90	90	27	27	27	27
80	130	130	130	130	35	35	35	35
100	170	170	170	170	45	45	45	45

1) Die Spannung ist

- für Funktionsisolierung: die höchste an der Luftstrecke zu erwartende Stoßspannung;
 - für Basisisolierung, falls direkt oder wesentlich beeinflusst durch transiente Überspannung aus dem Niederspannungsnetz: die Bemessungs-Stoßspannung des Betriebsmittels;
 - für andere Basisisolierung: die höchste Stoßspannung, die im Stromkreis auftreten kann;
- _) Vorzugswerte

Höhen-Korrekturfaktoren (Tabelle 2 b)

Höhe in m	Normaler Luftdruck in kPa	Multiplikationsfaktor für Abstände
2000	80,0	1,00
3000	70,0	1,14
4000	62,0	1,29
5000	54,0	1,48
6000	47,0	1,70
7000	41,0	1,95
8000	35,5	2,25
9000	30,5	2,62
10000	26,5	3,02
15000	12,0	6,67
20000	5,5	14,50

Bemessung der Kriechstrecke

Vereinfachtes Schema zur Ermittlung der Kriechstrecke

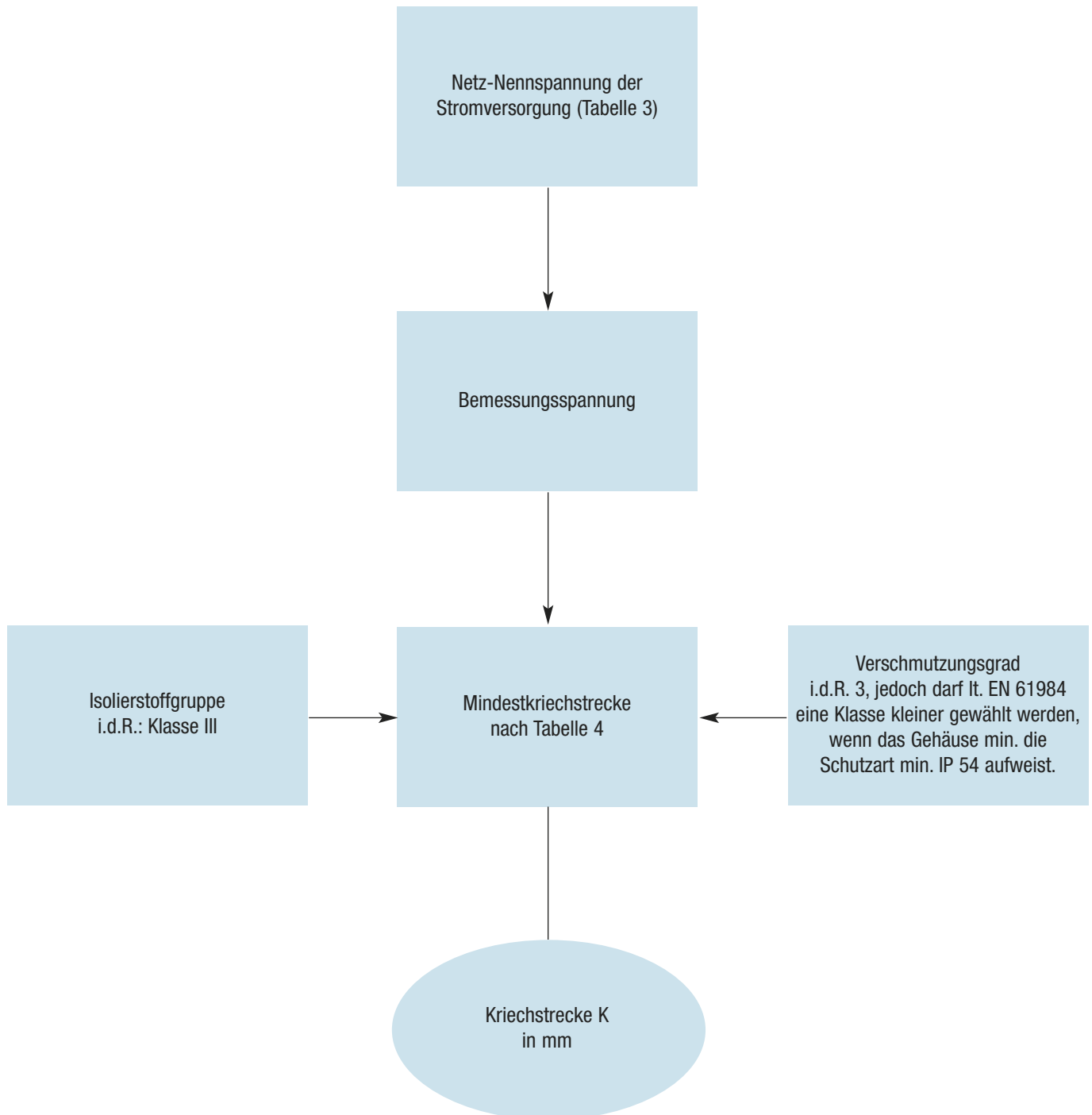

Netz-Nennspannung der Stromversorgung* [V]	Bemessungsspannung [V]
60	63
110/120/127	125
150	160
208	200
220/230/240	250
300	320
380/400/415	400
440	500
480/500	500
575	630
600	630
660/690	630
720/830	800
960	1000
1000	1000

Tabelle 3

* die Auswahl stellt nicht den vollständigen Zusammenhang zwischen allen möglichen weltweit verwendeten Netzformen und der Bemessungsspannung dar

Mindestkriechstrecke für Betriebsmittel mit langzeitiger Spannungsbeanspruchung												
Bemessungs Spannung [V]	Verschmutzungsgrad											
	1			2			3			4		
	I)	Isolierstoffgruppe		Isolierstoffgruppe		Isolierstoffgruppe		Isolierstoffgruppe		Isolierstoffgruppe		
	I)	I	II	III	I	II	III	I	II	III		
10	0,08	0,40	0,40	0,40	1,00	1,00	1,00	1,6	1,6	1,6		
12,5	0,09	0,42	0,42	0,42	1,05	1,05	1,05	1,6	1,6	1,6		
16	0,10	0,45	0,45	0,45	1,10	1,10	1,10	1,6	1,6	1,6		
20	0,110	0,48	0,48	0,48	1,20	1,20	1,20	1,6	1,6	1,6		
25	0,125	0,50	0,50	0,50	1,25	1,25	1,25	1,7	1,7	1,7		
32	0,140	0,53	0,53	0,53	1,30	1,30	1,30	1,8	1,8	1,8		
40	0,16	0,56	0,80	1,10	1,4	1,6	1,8	1,9	2,4	3,0		
50	0,18	0,60	0,85	1,20	1,5	1,7	1,9	2,0	2,5	3,2		
63	0,20	0,63	0,90	1,25	1,6	1,8	2,0	2,1	2,6	3,4		
80	0,22	0,67	0,95	1,3	1,7	1,9	2,1	2,2	2,8	3,6		
100	0,25	0,71	1,00	1,4	1,8	2,0	2,2	2,4	3,0	3,8		
125	0,28	0,75	1,05	1,5	1,9	2,1	2,4	2,5	3,2	4,0		
160	0,32	0,80	1,1	1,6	2,0	2,2	2,5	3,2	4,0	5,0		
200	0,42	1,00	1,4	2,0	2,5	2,8	3,2	4,0	5,0	6,3		
250	0,56	1,25	1,8	2,5	3,2	3,6	4,0	5,0	6,3	8,0		
320	0,75	1,60	2,2	3,2	4,0	4,5	5,0	6,3	8,0	10,0		
400	1,00	2,00	2,8	4,0	5,0	5,6	6,3	8,0	10,0	12,5		
500	1,30	2,50	3,6	5,0	6,3	7,1	8,0	10,0	12,5	16,0		
630	1,8	3,2	4,5	6,3	8,0	9	10,0	12,5	16	20		
800	2,4	4,0	5,6	8,0	10,0	11	12,5	16,0	20	25		
1000	3,2	5,0	7,1	10,0	12,5	14	16,0	20,0	25	32		

Tabelle 4

Degree of protection provided by enclosures

For safety reasons, electrical equipment needs to be protected against outside influences. The basis for the determination is the standard IEC 529 titled 'Degree of protection provided by enclosures (IP – Code)'.

Using a standardized test procedure the extent of the protection class is verified. To classify different housings according to their protection class, a designation system is used which consists of the code – letters 'IP' and two code numbers.

Arrangement of the IP – Code (International bzw. Ingress Protection)

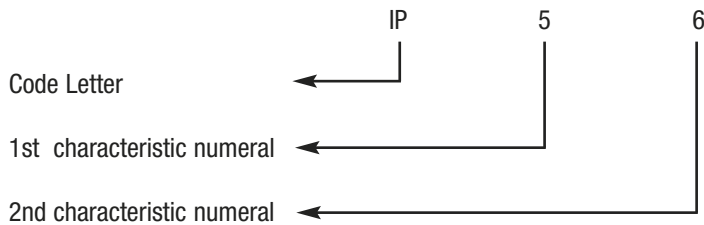

Meaning of the 1st characteristic numeral

The first numeral describes the protection of the housing against intrusion of foreign bodies as well as the protection of people against dangerous parts or influences. Because of this, there are two descriptions and definitions for each of the first code letter.

1st numeral	Protection against solid objects and against access to hazardous parts	
	short description	definition
0	no protection	
1	-protection against solid foreign bodies of Ø 50mm -protection against access to hazardous parts with the back of a hand	A sphere of Ø 50mm, must not intrude
2	-protection against solid foreign bodies of Ø 12 mm -protection against access to hazardous parts with the finger	A sphere of Ø 12mm diameter, must not intrude
3	-protection against solid foreign bodies of 2,5 mm diameter and bigger -protection against access to hazardous parts with a tool	A sphere of Ø 2,5mm diameter, must not intrude
4	-protection against solid foreign bodies of 1,0 mm diameter and bigger -protection against access to hazardous parts with a wire	The probe, sphere of Ø 1,0mm, must not intrude
5	protected against dust	The infiltration of dust is not completely prevented, but it does not infiltrate to such an extent that the operation or the safety of the device is affected.
6	dust proof	No infiltration of dust

Meaning of the 2nd characteristic numeral

The second numeral describes the protection of the housing against the intrusion of water with harmful effects.

second code digit	Protection degrees against the intrusion of water, designated by the second code digit	
	short description	definition
0	not protected	
1	protected against dripping water	Vertically falling drops shall have not harmful effects.
2	protected against dripping water when the housing is at an angle of up to 15°	Vertically falling drops shall have not harmful effects when the enclosure is tilted upto 15°
3	protected against water spray	Water sprayed at an angle up to 60°, shall have no harmful effects
4	protected against splash water	Water splashed against the enclosure from any direction shall have no harmful effects
4K	protected against splash water with increased pressure	Water splashed against the enclosure with increased pressure from any direction shall have no harmful effects (Applies acc to DIN 40050 - 9 only for road vehicles)
5	protected against jets of water	water splashes against the enclosure from any direction as a water jet shall have no harmful effects
6	protected against strong jets of water	water splashes against the enclosure from any direction as a strong water jet shall have no harmful effects
6K	protected against strong jets of water with increased pressure	water splashes directly against the enclosure from any direction as a strong water jet with increased pressure, shall have no harmful effects (Applies acc to DIN 40050 - 9 only for road vehicles)
7	protection against the effects of temporary submersion in water	Quantity of water that ingresses an enclosure, when it is temporarily immersed under standardized conditions of pressure and time, shall have no harmful effects.
8	protection against the effects of continuous submersion in water	Quantity of water that ingresses an enclosure, when it is continuously immersed under conditions of pressure and time, shall have no harmful effects. The conditions must, however be harder than for code digit 7 and agreed between user and producer.
9K	Protected against water during high-pressure / jet-stream cleaning.	Water that is directed against the housing with greatly increased pressure from any direction must not have any detrimental effect (Applies acc to DIN 40050 - 9 only for road vehicles)

Insulation Coordination for Electrical Connectors in Low Voltage Plants

Dimensioning of Clearance and Creeping Distances acc. to DIN EN60664-1; following pages show only a part of the standards

Insulation Coordination

Insulation coordination includes the design of the electrical insulation of a connector depending on its use and environment. This occurs either by design of the clearance distances (basis is the expected power surge) or by design of the creeping distance (basis is the operating voltage as well as the quality of the insulating material). Furthermore, insulation-changing conditions are taken into account (pollution, protective measures against pollution, air pressure, thermal or chemical influences).

Air distances are measured according to the outer or inner power surge expected. The four power surge classes (power surge categories I to IV) take the different use of the connector into account.

Depending on the homogeneity of the field between the electrodes (case A – inhomogenous field, case B – homogenous field) the air distances can be determined according to table 2a (minimum air distances); industrial connectors are always determined according to case A.

The influence from pollution when determining the air- and **creeping distances** is taken into account by using four degrees of severity (pollution degree 1 to 4).

Basis of the creeping distances is the rated voltage which is deduced from the operating voltage.

The minimum creeping distances are allocated in table 4 depending on the severity of pollution.

If the product descriptions do not contain any additional information the products listed in this catalogue were rated according to norm DIN VDE 0110 for surge category III and severity of pollution 3.

Surge Category I to IV

- resources of surge category I are goods for the termination of fixed electrical installations of a building. Measures for the limitation of transient surges were taken either in the fixed installation or between the fixed installation and the equipment.
- resources of surge category II are resources which use power and are fed from a fixed installation.
Note: e. g. domestic appliances, portable tools and other appliances as well as similar consumers.
- resources of surge category III are part of a fixed installation. They are resources from which a high degree of availability is expected.
Note: Examples for such appliances are e.g. industrial connectors, distribution panels, power switches, distributors, switches, sockets).
- Devices of surge category IV are for use at the supply terminal of the installation.
Note: Examples for such appliances are electricity counters, overload cut-out switches and Rundsteuergeräte.

Pollution Degree 1 to 4

DIN VDE 0110 defines the pollution degrees as follows: :

Pollution Degree 1:

There is no or only dry, non-conductive pollution. The pollution is without influence.

Pollution Degree 2:

There is only non-conductive pollution. Occasional momentary conductivity due to condensation.

Pollution Degree 3:

There is conductive pollution or dry non-conductive pollution, which becomes conductive due to condensation.

Pollution Degree 4:

There is a continuous conductivity due to conductive dust, rain or moisture.

Insulation Material

The insulation materials are divided into the following four groups depending on their comparative tracking index (CTI) :

Insulation material I:	$600 \leq \text{CTI}$
Insulation material II:	$400 \leq \text{CTI} < 600$
Insulation material III a:	$175 \leq \text{CTI} < 400$

Measurement of Clearances

Diagram for the Determination of Clearances

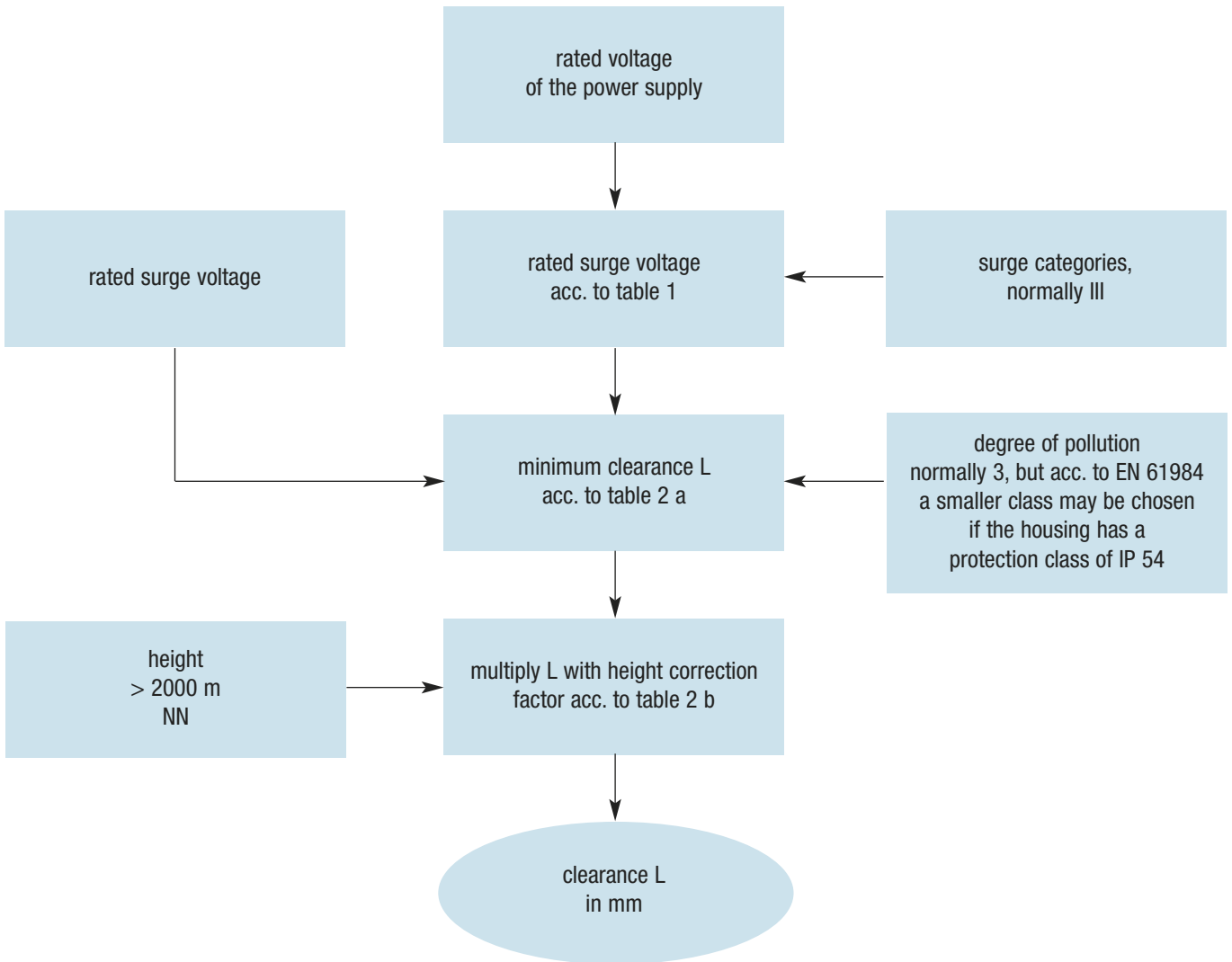

Rated Surge Voltage for Utilities					
rated voltage of the power supply *) in V		Rated Surge Voltage in kV (1,2/50ms) for			
3-phase systems	single systems in the centre	utilities at the feed of the installation (surge category IV)	utilities as part of a fixed installation (surge category III)	utilites for connection to fixed installations (surge category II)	Specially protected utilities (surge category I)
	120 up to 240	4	2,5	1,5	0,8
230/400**		6	4	2,5	1,5
277/480**					
400/690**		8	6	4	2,5
1000		12	8	6	4

*) chosen voltage values

**) the / dash is for a 3-phase system with 4 lines. The lower value is for phase to neutral, the higher value is for phase to phase

minimum clearance in air at installation heights of up to 2000 m above sea level (NN)								
"rated surge voltage [kV]"	case A inhomogenous field) degree of pollution				case B homogenous field) degree of pollution			
	1 (mm)	2 (mm)	3 (mm)	4 (mm)	1 (mm)	2 (mm)	3 (mm)	4 (mm)
0,33 _)	0,01	_)	0,80	1,6	0,01	_)	0,8	1,6
0,40	0,02				0,02			
0,5 _)	0,04				0,04			
0,60	0,06				0,06			
0,80 _)	0,10				0,10			
1,0	0,15	0,25	1,0	1,6	0,15	0,2	0,8	1,6
1,2	0,25				0,2			
1,5 _)	0,5				0,5			
2,0	1,0	1,0	1,0	0,45	0,5	1,2	1,2	
2,5 _)	1,5	1,5	1,5	0,6	0,6			
3,0	2	2	2	0,8	0,8			
4,0 _)	3	3	3	3	1,2	1,2	1,2	1,2
5,0	4	4	4	4	1,5	1,5	1,5	1,5
6,0 _)	5,5	5,5	5,5	5,5	2	2	2	2
8,0 _)	8	8	8	8	3	3	3	3
10	11	11	11	11	3,5	3,5	3,5	3,5
12 _)	14	14	14	14	4,5	4,5	4,5	4,5
15	18	18	18	18	5,5	5,5	5,5	5,5
20	25	25	25	25	8	8	8	8
25	33	33	33	33	10	10	10	10
30	40	40	40	40	12,5	12,5	12,5	12,5
40	60	60	60	60	17	17	17	17
50	75	75	75	75	22	22	22	22
60	90	90	90	90	27	27	27	27
80	130	130	130	130	35	35	35	35
100	170	170	170	170	45	45	45	45

- 1)This voltage is
- for functional insulation: the maximum impulse voltage expected to occur across the clearance
 - for basic insulation directly exposed by transient overvoltages
 - for other basic insulation

_) Preferred values

Factors for Height Correction		
height in m	normal air pressure in kPa	multiplication factor for distances
2000	80,0	1,00
3000	70,0	1,14
4000	62,0	1,29
5000	54,0	1,48
6000	47,0	1,70
7000	41,0	1,95
8000	35,5	2,25
9000	30,5	2,62
10000	26,5	3,02
15000	12,0	6,67
20000	5,5	14,50

Measurement of creepage

Diagram for the Determination of creepage

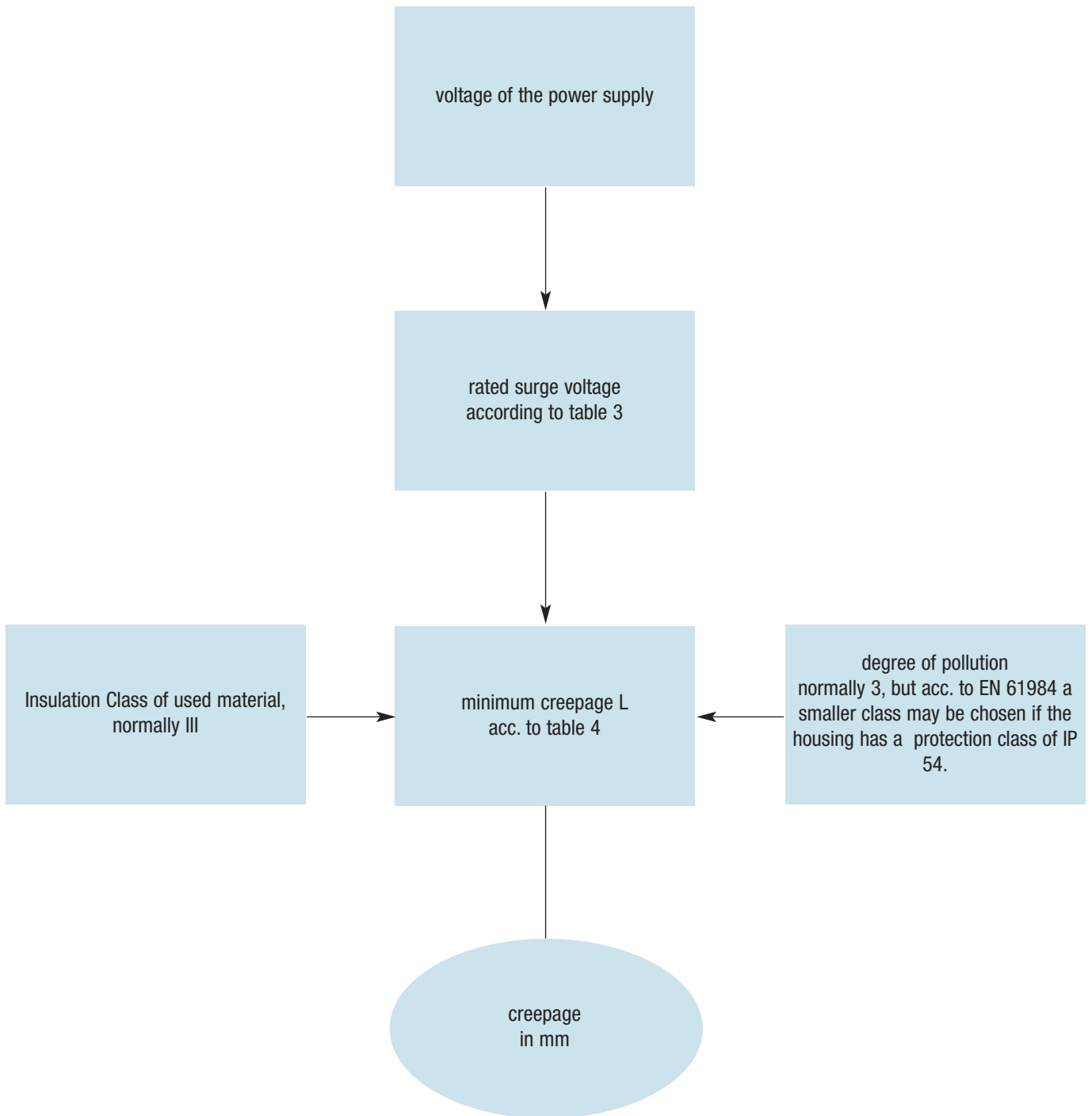

voltage of the power supply [V]	Rated voltage [V]
60	63
110/120/127	125
150	160
208	200
220/230/240	250
300	320
380/400/415	400
440	500
480/500	500
575	630
600	630
660/690	630
720/830	800
960	1000
1000	1000

Table 3

* the above shown table does not give the entire correlation of world-wide used networks and rated voltages; it is reduced to the most common ones; further details, see DIN EN60664-1

Creepage in [mm] for electrical Equipments										
rated voltage [V]	degree of pollution									
	1 All Insulator classes	2 Insulation Class			3 Insulation Class			4 Insulation Class		
		I	II	III	I	II	III	I	II	III
10	0,08	0,40	0,40	0,40	1,00	1,00	1,00	1,6	1,6	1,6
12,5	0,09	0,42	0,42	0,42	1,05	1,05	1,05	1,6	1,6	1,6
16	0,10	0,45	0,45	0,45	1,10	1,10	1,10	1,6	1,6	1,6
20	0,110	0,48	0,48	0,48	1,20	1,20	1,20	1,6	1,6	1,6
25	0,125	0,50	0,50	0,50	1,25	1,25	1,25	1,7	1,7	1,7
32	0,140	0,53	0,53	0,53	1,30	1,30	1,30	1,8	1,8	1,8
40	0,16	0,56	0,80	1,10	1,4	1,6	1,8	1,9	2,4	3,0
50	0,18	0,60	0,85	1,20	1,5	1,7	1,9	2,0	2,5	3,2
63	0,20	0,63	0,90	1,25	1,6	1,8	2,0	2,1	2,6	3,4
80	0,22	0,67	0,95	1,3	1,7	1,9	2,1	2,2	2,8	3,6
100	0,25	0,71	1,00	1,4	1,8	2,0	2,2	2,4	3,0	3,8
125	0,28	0,75	1,05	1,5	1,9	2,1	2,4	2,5	3,2	4,0
160	0,32	0,80	1,1	1,6	2,0	2,2	2,5	3,2	4,0	5,0
200	0,42	1,00	1,4	2,0	2,5	2,8	3,2	4,0	5,0	6,3
250	0,56	1,25	1,8	2,5	3,2	3,6	4,0	5,0	6,3	8,0
320	0,75	1,60	2,2	3,2	4,0	4,5	5,0	6,3	8,0	10,0
400	1,00	2,00	2,8	4,0	5,0	5,6	6,3	8,0	10,0	12,5
500	1,30	2,50	3,6	5,0	6,3	7,1	8,0	10,0	12,5	16,0
630	1,8	3,2	4,5	6,3	8,0	9	10,0	12,5	16	20
800	2,4	4,0	5,6	8,0	10,0	11	12,5	16,0	20	25
1000	3,2	5,0	7,1	10,0	12,5	14	16,0	20,0	25	32

Table 4

Technische Kennwerte Serie HF/Technical specifications Series: HF

Crimphülse

- Optimale Materialanpassung entsprechend der Kundenapplikation
- Anpassung auf spezielle Leiterquerschnitte und Verarbeitungswerkzeuge
- Verwendung der gleichen Crimphülse für Stift-, Buchsen- und Erdkontakt
- Robuste widerstandsfähige Crimphülse für vielfältige Industrieapplikationen

- ② Kontaktträger
- ③ Adapter
- ④ Crimphülse



Crimp ferrule

- Optimum material adaptation according to customer's application
- Adaptation to special customer wire size and crimping tools
- Same crimp ferrule for male, female and grounding contact
- Robust crimp ferrule for tough industrial applications

- ② Insulating material plastic
- ③ Adapter
- ④ Crimp ferrule

Male/female contact

- Wear-resistant basic material
- Worn parts can be individually exchanged
- Surface coating according to customer application
- 30% reduced mating and pulling forces
- 50% increase of making cycles
- Variable wire termination

Stift-/ Buchsenkontakt

- Verschleißarmes Basismaterial
- Austausch der Einzelteile durch modularen Aufbau
- Oberflächenveredlung gemäß Kundenanwendungsanforderung
- Reduzierung der Steck-/Ziehkräfte um 30%
- Erhöhung der Steckzyklen um 50%
- Variable Anschlußtechnik

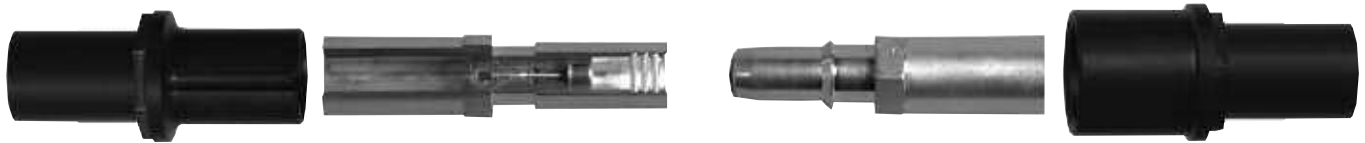

Bemessungsstrom	350 A
Bemessungsspannung	1000 V~, Isolationsgruppe C
Prüfspannung	3 (C)
Prüfspannung U_{eff}	3 kV
Durchgangswiderstand	≤ 1 mΩ
Isolationswiderstand	≥ 10 ¹⁰ Ω
Temperaturbereich	- 40°C + 125°C Die obere Grenztemperatur schließt die Kontaktenerwärmung und Erwärmung durch Umgebungstemperatur ein
Kabel Anschluß	Crimpanschluß 50 - 150 mm ²
Werkstoffe	
Kontakteinsätze	thermoplastischer Formstoff glasfaserverstärkt (UL-gelistet) V-0
Kontaktelemente	Kupferlegierung
Kontaktoberfläche	hartversilbert

Rated current	350 A
Rated voltage	1000V~, insulation group C
Test voltage	3 (C)
Test voltage U_{rms}	3 kV
Volume resistance	≤ 1 mΩ
Insulation resistance	≥ 10 ¹⁰ Ω
Temperature range	- 40°C + 125°C The maximal limit temperature includes contact heat-up and heat-up caused by ambient temperature.
Wire termination	Crimp terminal 50 - 150 mm ²
Materials	
Contact inserts	thermoplastic material glass-fibre reinforced (UL listed) V-0
Contact elements	copper alloy
Contact surfaces	hard-silver-plated

Kontaktzahlen/ No. of contacts	8	14	23	35	48
Baugröße/ Size	3	4	6	8	8

Technische Kennwerte Serie MDL/Technical specifications series MDL

- Modular aufgebaute Kontakteinsätze - Baugröße 3-4-6-8-10-12
- Optimale Flexibilität, leichtes Handling, schnelle Montage
- Rationelle Mischbestückung zur Lösung anwenderspezifischer Kundenanforderungen
- Halterahmen zur Aufnahme der variabel einsetzbaren Module, baugleich für Ober- und Unterteil
- Reduzierung der Lagerbestandskosten
- Polarisierter Einsatz der Module in einem Halterahmen
- Leistungs- und Signalübertragung über einen Steckverbinder
- Voreilende Schutzkontakte
- Elektromagnetisch verträgliche Module für Bussystem-Schnittstellen

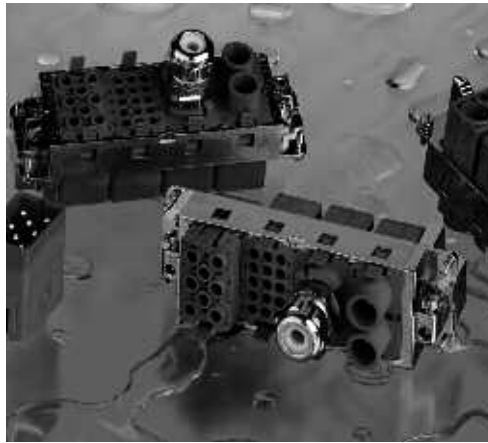

- Modular contact inserts – sizes 3-4-6-8-10-12
- Optimum flexibility, easy handling, quick assembly
- Rational mixing of connectors, i. e. application specific customer requirements can be solved
- Fixing frame to hold the interchangeable modules, same design for upper and lower part
- Storage costs are reduced
- Polarized use of the modules in a fixing frame
- Power- and signal transmission with one connector
- Leading grounding contact
- Modules, tolerant to electro-magnetic waves, for bus system interfaces

Vorschriften	DIN VDE 0110 für Luft- und Kriechstrecken DIN VDE 0627 für Steckverbinder und Steckvorrichtungen
Zulassungen	UL, CSA
Modulbaustein	
Verschmutzungsgrad	3
Werkstoff	thermoplastischer Formstoff
Temperaturbereich	- 40°C + 125°C
Brennbarkeit	nach UL 94 V-0

Regulations	DIN VDE 0110 für clearance and tracking distance DIN VDE 0627 for connectors, plugs and sockets
Approvals	UL, CSA
Module element	
Degree of contamination	3
Material	thermoplastics
Temperature range	- 40°C + 125°C
Flammable	acc. to UL 94 V-0

Modulbausteine Module elements	Modulbezeichnung Moduldesignation	Elektrische Kennwerte/Pneumatic Electrical ratings/Pneumatic	Kontaktzahlen No. of contacts
Last/Signal/Power <i>Signal</i>	MDL-HF 1+2	1 x (150A/1000V), 2 x (10A/250V)	3
Last/Signal/Power <i>Signal</i>	MDL-HSS 2+2	2 x (63A/1000V), 2 x (10A/250V)	4
Last/Signal/Power <i>Signal</i>	MDL-HSM 3 + 4	3 x (40A/1000V), 4 x (10A/250V)	7
Pneumatik/ <i>Pneumatic</i>	MDL-AIR	10 bar, NW = 4,0	2
Signal/ <i>Signal</i>	MDL-HN.D	15 x (10A/400V)	15, 18
Signal/ <i>Signal</i>	MDL-HD	18 x (10A/250V)	15, 18
LWL/ <i>Optical transmission</i>	MDL-LWL		18
Signal/ <i>Signal</i>	MDL-HVT	8 x (16A/400V)	8
Signal/ <i>Signal</i>	MDL-Twinax	4 x (16A/150V)	4
Signal/ <i>Signal</i>	MDL-KX	6x RG 58/RG 59	6
Signal/ <i>Signal</i>	MDL-KX.VT		1
Signal/ <i>Signal</i>	MDL-Dynamic	30 x (5A/600V)	30
Signal/ <i>Signal</i>	MDL-RJ45	CAT 5e	1

Anschlussarten/Termination types

- **Schraubanschluss**
Screw connection



- **Spring Clamp-Anschluss**
Spring Clamp connection



- **Crimpschluss**
Crimp connection

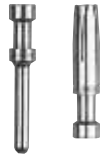

Schraubanschluss/Screw terminal

Schraubanschluss

Der Schraubanschluss ist die bekannteste Anschlussart. Ihre Bemessung erfolgt nach VDE 0609. Anzugs- und Prüfdrehmomente entnehmen Sie bitte nebenstehender Tabelle.

Screw terminal

The screw terminal is the most common type of connection. Ratings are based on VDE 0609. Please refer to the table at the left for torques.

Leiterquerschnitt (mm ²)	1	1,5	2,5	4	6	10	Wire cross section (mm ²)
Schraubengewinde	M 2,6	M 3	M 3	M 3,5	M 4	M 4	Thread
Prüfdrehmoment Ncm	40	50	50	80	120	120	Test torque Ncm

Das Diagramm zeigt den Streubereich der Ausziehungskräfte der Leiter aus der Schraubverbindung eines Kontaktelementes mit Klemmschutz. Klemmschraube: M 3 Prüfdrehmoment: 50 Ncm

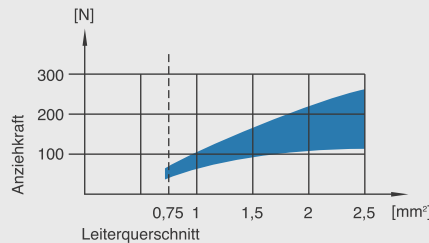

The diagram shows the force range for pulling the conductor out of the screwed connection of a contact element with wire protection. Clamp screw: M 3 Test torque: 50 Ncm

Die einschlägigen Bestimmungen sagen aus:

- Serien HE, HSB-Klemmen **mit Drahtschutz:** Ausser dem Abisolieren ist kein besonderes Herrichten der Leiterenden erforderlich.

mit Drahtschutz/with wire protection

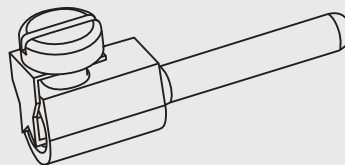

The relevant regulations stipulate:

- Terminals of series HE, HSB **with wire protection:** No special preparation of wire ends required except for stripping.

Kontakt-Einsätze Contact inserts	max. Leiterquerschnitt max. wire cross section mm ²	Abisolierlänge Stripping length	
		AWG	l (mm)
HA.3/HA.4	2,5	14	4,5
HE.6-48/HA.10-64	2,5	14	7,0
HSB.6/35	6,0	10	11,5

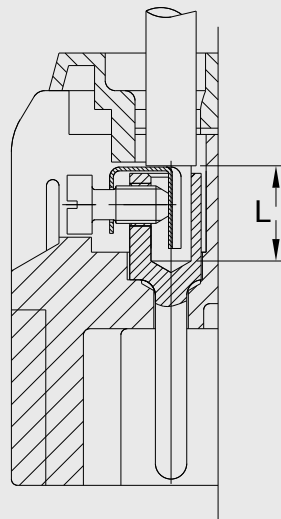

HA Spring Clamp-Anschluss/HA Spring Clamp connection

Technische Kennwerte

Vorschriften: DIN VDE 0110
DIN VDE 0627

Zulassungen: UL/CSA/SEV/VDE

Käfigzugfederanschluß: bis 2,5mm² (AWG 14)
mit Aderendhülse bis 1,5mm² (AWG 16)

Werkstoffe
Kontaktelemente: Kupferlegierung
Kontaktfläche: hartversilbert

Technical ratings

Specification: *DIN VDE 0110*
DIN VDE 0627

Approval: *UL/CSA/SEV/VDE*

Cage clamp terminal: *up to 2,5mm² (AWG 14)*
with wire pin up to 1,5mm² AWG 16)

Materials

Contact elements: *copper alloy*
Contact surface: *hard-silver-plated*

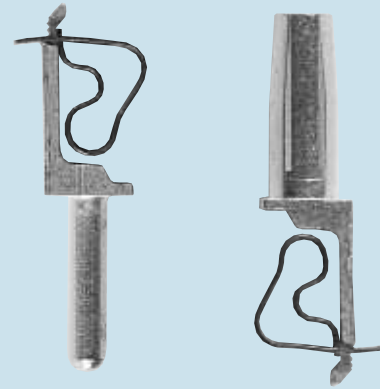

Kontaktanordnung
Ansicht Anschlußseite
Contact arrangements
view from terminal side



Montageausschnitt für Kontakteinsätze bei Verwendung ohne Geh:
Panel cut-out

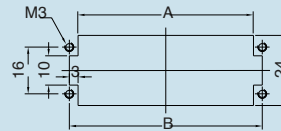

Baugröße/Size Maße/Dimensions

	A	B
2	43,5	49,5
5	60	66

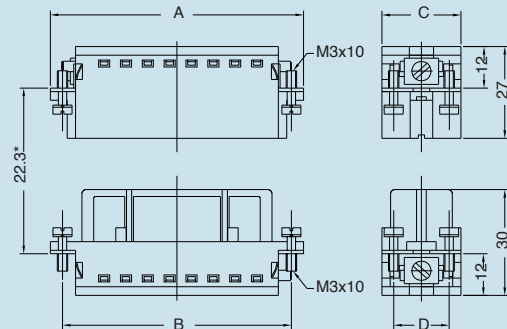

*Abstand für sichere Kontaktgabe 24 mm

Baugröße/Size	Maße/Dimensions			
	A	B	C	D
2	56,5	49,5	22,8	16
5	73	66	22,8	16

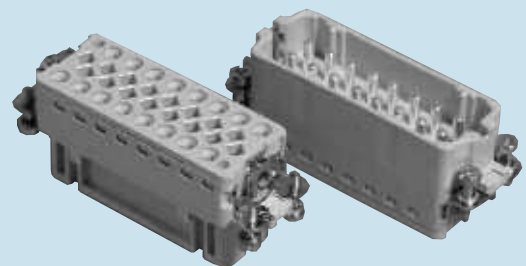

HE Spring Clamp-Anschluss/HE Spring Clamp connection

Technische Kennwerte

Vorschriften:	DIN VDE 0110 DIN VDE 0627
Zulassungen:	UL/CSA/SEV/VDE
Käfigzugfederanschluß:	bis 2,5mm ² (AWG 14)
Kontakteinsätze:	Thermoplastischer Formstoff PBT
Kontaktelemente:	Kupferlegierung
Kontaktoberfläche:	hartversilbert

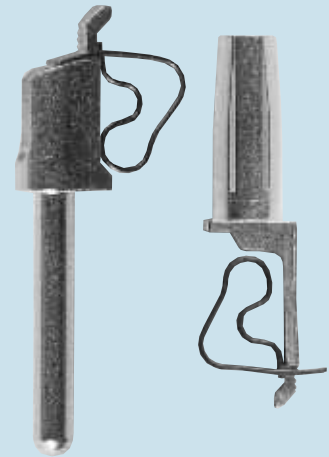

Technical ratings

Specification:	DIN VDE 0110 DIN VDE 0627
Approval:	UL/CSA/SEV/VDE
Cage clamp terminal:	up to 2,5mm ² (AWG 14) with wire pin up to 1,5mm ² (AWG 16)

Materials

Contact elements:	copper alloy
Contact surface:	hard-silver-plated

Montageausschnitt für Kontakteinsätze bei Verwendung ohne Gehäuse
Panel cut-out

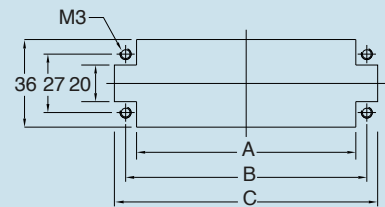

Baugröße Size	Abmessungen/Dimensions (mm)		
	A	B	C
3	37	44	52
4	50	57	65
6	70,5	77,5	85,5
8	97	104	112

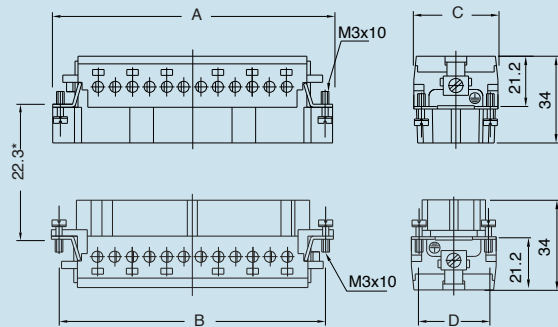

Baugröße/Size	Maße/Dimensions			
	A	B	C	D
3	52	44	33	27
4	63	57	33	27
6	83,5	77,5	33	27
8	110	104	33	27

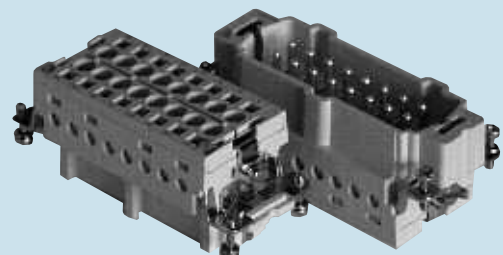

Crimpkontakte/Crimp contacts

Die moderne Crimp-Anschlußtechnik weist gegenüber Schraub- oder Lötanschlüssen wesentliche technische und wirtschaftliche Vorteile auf.

Zum Crimpen werden ein- oder mehrdrähtige Leiter eingesetzt. Der Crimpvorgang kann durch Crimp-Handzangen oder für die Serienfertigung mit halb- oder vollautomatischen Crimpmaschinen erfolgen. Mit Vollautomaten geschieht das Abisolieren der Leiter und das Crimpen der Kontakte maschinell in einem Arbeitsgang. Mit Hilfe dieser Crimpwerkzeuge wird der Anschlußbereich des Crimpkontaktes verformt und somit eine feste, gasdichte Verbindung mit dem Leiter hergestellt.

HTS bietet wirtschaftliche und technische Vorteile mit zwei weltweit verbreiteten Crimpsystemen:

- Präzisions-gedrehte HE, HN.D, HVT, HSM, HSL und HSS-Massiv-Crimpkontakte.
- Präzisions-gestanzte HD.M-Crimpkontakte.

1. Die gleichbleibende Crimpqualität garantiert einen konstanten Durchgangswiderstand.
2. Korrosionsfestigkeit durch annähernde Kaltverschweißung.
3. Vorkonfektionierung von Kabelbäumen mit Crimpkontakten.
4. Wesentlich höhere Verdrahtungsgeschwindigkeit.
5. Das Lösen bereits gesteckter Kontakte ist mit speziellem Lösewerkzeug möglich.

Auswahlhilfe Silber/Goldkontakte:

Die Auswahl o.g. Materialien sollte vor folgendem Hintergrund stattfinden:

Verschleiß ist auf Grund der Härte der Goldoberfläche bei vergoldeten Kontakten geringer, was auch höhere Steckzyklen erlaubt. Auch ist die Steckkraft bei vergoldeten Kontakten geringer. Das **Widerstandsverhalten** bei Gold ist konstanter aufgrund der geringeren Reaktionsfreudigkeit: Silber reagiert mit Schwefel und bildet eine dünne Oxidschicht aus. Diese Schicht wird beim Stecken problemlos durchbrochen bzw. von größeren Strömen „verbrannt“.

Unserer Erfahrung nach ist ein Einsatz von Goldkontakten nur bei Signal-Stößen und -Spannungen aufgrund des sehr konstanten (zeitlich) Widerstandsverhalten notwendig. Bei Anwendungen >5mA und >5V ist der Einsatz von Silberkontakten aus wirtschaftlichen Gesichtspunkten sinnvoller.

In nebenstehender Grafik ist diese Strom/Spannungs Auswahl zusammengefaßt.
 Spez. Widerstand: Gold: 0,022 Vmm_/m
 Silber: 0,015 Vmm_/m

Schliffbilder einer Crimpstelle
 Cross sections of crimp contacts

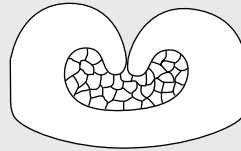

F-Crimpfung für HD.M-Kontakte
 F crimp for HD.M contacts

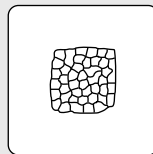

Vierkant Crimpung
 Square section crimping

State-of-the-Art crimping technology is superior to screw or solder terminals compared to technical and economic perspectives.

Solid or multi strand conductors can be used for crimping. Crimping is done with manual crimping tools or semi-automatic crimping machines. Fully automatic machines perform all processes from stripping the conductor to crimping the contacts in a single step. The crimping tools connect the contact and the conductor by applying pressure to the connection area of the contact, thus creating a reliable, gas-tight termination.

HTS offers technical and economic advantages with two world-wide proven and acknowledged crimping systems:

- precision-screw machined solid crimp contacts HE, HN.D, HVT, HSM, HSL and HSS.
- precision-stamped HD.M crimp contacts

1. The constant crimp quality ensures a constant resistance.
2. Connection is almost cold-welded, giving corrosion resistance to the termination.
3. Preparation of cable harness with crimp contacts.
4. Faster termination times.
5. Crimped contacts can be removed with a special tool.

How to choose between silver- or gold-plated contacts:

The choice of either silver- or gold-plated contacts should be made considering the following: The surface of gold-plated contacts is harder, which means less wear and tear and enables higher mating cycles. The mating force of gold-plated contacts is lower as well.

Gold's resistance performance is more constant due to its low reactivity. Silver reacts with sulphur and forms a thin oxidation layer. When mating this layer can be broken through or 'burnt off' by higher currents.

Our experience has shown that the use of gold-plated contacts is only necessary with signal currents and voltages when very constant resistance performance is required. From an economic point of view it makes more sense to use silver-plated contacts for applications of >5mA and >5V. The graphic shown left is the current/voltage choice.

Resistance: Gold: 0,022 Vmm_/m
 Silver: 0,015 Vmm_/m

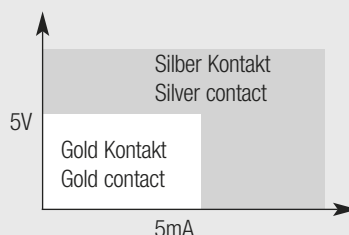

Crimpkontakte S20DF Serie/Crimp contacts S20DF series

5A

Bezeichnung Description	Bestelltext Designation	Bestell-Nr. Order No.	Maße mm ² Dimensions mm ²
<p>Stiftkontakt/<i>Pin contact</i></p> <p>Buchsenkontakt/<i>Socket contact</i></p> <p>Werkstoff: Kupferlegierung Oberfläche: - vergoldet Durchgangswiderstand: ≤ 15 mΩ Crimpanschluss: - mm² 0,08 - 0,6 mm² - AWG 28 - 20</p> <p><i>Material: Copper alloy</i> <i>Finish:</i> - gold plated <i>Contact resistance: ≤ 15 mΩ</i> <i>Crimp terminal :</i> - mm² 0,08 - 0,6 mm² - AWG 28 - 20</p>	<p>Stiftkontakt vergoldet <i>Pin contact gold plated</i></p> <p>Bandkontakt/Stift vergoldet <i>Reel contact/pin gold plated</i></p> <p>Buchsenkontakt vergoldet <i>Socket contact gold plated</i></p> <p>Bandkontakt/Buchse vergoldet <i>Reel contact/socket gold plated</i></p>	<p>1-66507-0 1-66506-0</p> <p>66507-4 66506-4</p> <p>1-66505-0 1-66504-0</p> <p>66505-4 66504-4</p>	<p>0,08 – 0,2 0,2 – 0,6</p> <p>0,08 – 0,2 0,2 – 0,6</p> <p>0,08 – 0,2 0,2 – 0,6</p> <p>0,08 – 0,2 0,2 – 0,6</p>

Werkzeuge für Crimptechnik S20DF Serie/Crimping tools S20DF series

Bezeichnung Description	Bestelltext Designation	Bestell-Nr. Order No.	Querschnitt mm ² Cross section mm ²
<p>Crimpzange <i>Crimping tool</i></p>	<p>Certi-Crimp Reel-Fed Certi Lok*</p>	<p>169424-1</p>	
<p>Ausdrückwerkzeug /<i>Extraction tool</i></p>	<p>S20DF</p>	<p>91285-1</p>	<p>alle Querschnitte <i>all cross sections</i></p>
<p>Eindrückwerkzeug/<i>Insertion tool</i></p>	<p>S20DF</p>	<p>726363-1</p>	

*für Bandkontakte/lor reel contacts

Crimpkontakte Dynamic 2800 Serie/Crimp contacts Dynamic 2800 series

5A

Bezeichnung Description	Bestelltext Designation	Bestell-Nr. Order No.	Maße mm ² Dimensions mm ²	Werkzeug Tool
<p>Buchsenkontakt/Receptable contact Stiftkontakt/Top contact</p> <p>Werkstoff: Kupferlegierung <i>Material: Copper alloy</i> Oberfläche: <i>Finish:</i> - vergoldet - gold plated Durchgangswiderstand: ≤ 3 mΩ <i>Contact resistance: ≤ 3 mΩ</i> Crimpanschluss: <i>Crimp terminal :</i> - mm² 0,08 - 0,85 mm² - mm² 0,08 - 0,85 mm² - AWG 28 - 18 - AWG 28 - 18</p>	Stiftkontakt vergoldet <i>Top contact gold plated</i>	1318112-1 1318111-1	0,08 – 0,2 (S) 0,3 – 0,85 (M)	91576-1 91595-1
	Bandkontakt/Stift vergoldet <i>Strip form Top contact gold plated</i>	1318110-1 1318109-1	0,08 – 0,2 (S) 0,3 – 0,85 (M)	(Applicator) 1385232-2 1385231-2
	Buchsenkontakt vergoldet <i>Receptable contact gold plated</i>	1318108-1 1318107-1	0,08 – 0,2 (S) 0,3 – 0,85 (M)	91596-1 91595-1
	Bandkontakt/Buchse vergoldet <i>Strip form Receptable contact gold plated</i>	1318106-1 1318105-1	0,08 – 0,2 (S) 0,3 – 0,85 (M)	(Applicator) 1385232-2 1385231-2

Crimpkontakte Dynamic 3800 Serie/Crimp contacts Dynamic 3800 series

8A

Bezeichnung Description	Bestelltext Designation	Bestell-Nr. Order No.	Maße mm ² Dimensions mm ²	Werkzeug Tool
<p>Buchsenkontakt/Receptable contact Stiftkontakt/Top contact</p> <p>Werkstoff: Kupferlegierung <i>Material: Copper alloy</i> Oberfläche: <i>Finish:</i> - vergoldet - gold plated Durchgangswiderstand: ≤ 3 mΩ <i>Contact resistance: ≤ 3 mΩ</i> Crimpanschluss: <i>Crimp terminal :</i> - mm² 0,06 - 2,2 mm² - mm² 0,06 - 2,2 mm² - AWG 28 - 14 - AWG 28 - 14</p>	Stiftkontakt vergoldet <i>Top contact gold plated</i>	175287-2 175288-2 175289-2 987512-2	0,06 – 0,2 (S) 0,2 – 0,5 (M) 0,5 – 1,25 (L) 1,25 – 2,2 (2L)	91565-1 91559-1 91558-1 91560-1
	Bandkontakt/Stift vergoldet <i>Strip form Top contact gold plated</i>	175284-2 175285-2 175286-2 917485-2	0,06 – 0,2 (S) 0,2 – 0,5 (M) 0,5 – 1,25 (L) 1,25 – 2,2 (2L)	(Applicator) 1276659-1 937472-1 1385001-2 1276662-1
	Buchsenkontakt vergoldet <i>Receptable contact gold plated</i>	175216-2 175217-2 175218-2 917511-2	0,06 – 0,2 (S) 0,2 – 0,5 (M) 0,5 – 1,25 (L) 1,25 – 2,2 (2L)	91565-1 91559-1 91558-1 91560-1
	Bandkontakt/Buchse vergoldet <i>Strip form Receptable contact gold plated</i>	175194-2 175195-2 175196-2 917484-2	0,06 – 0,2 (S) 0,2 – 0,5 (M) 0,5 – 1,25 (L) 1,25 – 2,2 (2L)	(Applicator) 1276659-1 937472-1 1385001-2 1276662-1

Crimpkontakte HN.D Serie/Crimp contacts HN.D series **10A**

Bezeichnung Description	Bestelltext Designation	Bestell-Nr. Order No.	Maße mm ² Dimensions mm ²																		
<p>Stiftkontakt/<i>Pin contact</i></p> <p>Buchsenkontakt/<i>Socket contact</i></p> <p>Werkstoff: Kupferlegierung Oberfläche: - hartversilbert - hartvergoldet Durchgangswiderstand: ≤ 3 mΩ Crimpanschluss: - mm² 0,14 - 2,5 mm² - AWG 26 - 14</p> <p><i>Material: Copper alloy</i> <i>Finish:</i> - hard silver - hard gold <i>Contact resistance: ≤ 3 mΩ</i> <i>Crimp terminal :</i> - mm² 0,14 - 2,5 mm² - AWG 26 - 14</p>	Stiftkontakt versilbert <i>Pin contact silver plated</i>	1-1105050-1 2-1105050-1 3-1105050-1 4-1105050-1 5-1105050-1	0,14-0,37 0,5 0,75-1,0 1,5 2,5																		
	Stiftkontakt vergoldet <i>Pin contact gold plated</i>	1-1105050-2 2-1105050-2 3-1105050-2 4-1105050-2 5-1105050-2	0,14-0,37 0,5 0,75-1,0 1,5 2,5																		
<p>HN.D – Gedrehte Crimpkontakte/<i>Screw machined crimp contacts</i> Querschnittskennzeichnung/<i>Designation of cross section</i></p> <table border="1"> <thead> <tr> <th>Kennzeichnung <i>Designation</i></th> <th>Leiterquerschnitt <i>Wire cross section</i></th> <th>Abisolierlänge der Litze <i>Stripping length</i></th> </tr> </thead> <tbody> <tr><td>1</td><td>0,14 - 0,37 mm²</td><td>8 mm</td></tr> <tr><td>2</td><td>0,5 mm²</td><td>8 mm</td></tr> <tr><td>3</td><td>0,75 - 1 mm²</td><td>8 mm</td></tr> <tr><td>4</td><td>1,5 mm²</td><td>8 mm</td></tr> <tr><td>5</td><td>2,5 mm²</td><td>6 mm</td></tr> </tbody> </table>	Kennzeichnung <i>Designation</i>	Leiterquerschnitt <i>Wire cross section</i>	Abisolierlänge der Litze <i>Stripping length</i>	1	0,14 - 0,37 mm ²	8 mm	2	0,5 mm ²	8 mm	3	0,75 - 1 mm ²	8 mm	4	1,5 mm ²	8 mm	5	2,5 mm ²	6 mm	Buchsenkontakt versilbert <i>Socket contact silver plated</i>	1-1105051-1 2-1105051-1 3-1105051-1 4-1105051-1 5-1105051-1	0,14-0,37 0,5 0,75-1,0 1,5 2,5
	Kennzeichnung <i>Designation</i>	Leiterquerschnitt <i>Wire cross section</i>	Abisolierlänge der Litze <i>Stripping length</i>																		
1	0,14 - 0,37 mm ²	8 mm																			
2	0,5 mm ²	8 mm																			
3	0,75 - 1 mm ²	8 mm																			
4	1,5 mm ²	8 mm																			
5	2,5 mm ²	6 mm																			
	Buchsenkontaktvergoldet <i>Socket contact gold plated</i>	1-1105051-2 2-1105051-2 3-1105051-2 4-1105051-2 5-1105051-2	0,14-0,37 0,5 0,75-1,0 1,5 2,5																		

Werkzeuge für Crimptechnik HN.D Serie/Crimping tools HN.D series

Bezeichnung Description	Bestelltext Designation	Bestell-Nr. Order No.	Querschnitt mm ² Cross section mm ²
Crimpzange ohne Locator und Matrize <i>Crimping tool without locator and die</i>	RSZ.BAS	1-1105850-8	
Crimpzange mit Locator und Matrize <i>Crimping tool with locator and die</i>	RSZ.HE-HN.D-HVT	1-1105851-8	
Locator und Matrize 0,14 – 4mm ² <i>Locator and die 0,14 – 4mm²</i>	RSZ.LC 0,14-4 mm ²	1-1105852-8	0,14-4mm ²
Crimpzange ohne Locator <i>Crimping tool without locator</i>	Daniels Tool AF8	601967-1	
Locator hierzu <i>Locator for the tool</i>	Turnet	523168-5	
Ausdrückwerkzeug HN.D/ <i>Extraction tool HN.D</i>	AWZG-HN.D-RSZ	0-1102855-2	alle Querschnitte all cross sections
Eindrückwerkzeug/ <i>Insertion tool</i>	EWZG-RSZ	0-1102855-6	

Crimpkontakte HD.M Serie/Crimp contacts HD.M series

10A

Bezeichnung Description	Bestelltext Designation	Bestell-Nr. Order No.	Maße mm ² Dimensions mm ²															
<p>Stiftkontakt/<i>Pin contact</i></p> <p>Buchsenkontakt/<i>Socket contact</i></p> <p>Werkstoff: Kupferlegierung Oberfläche: - verzinkt - hartvergoldet Durchgangswiderstand: ≤ 3 mΩ Crimpanschluss: - mm² 0,14 - 2,5 mm² - AWG 26 - 14</p> <p>Material: <i>Copper alloy</i> Finish: - tin plated - hard gold Contact resistance: ≤ 3 mΩ Crimp terminal : - mm² 0,14 - 2,5 mm² - AWG 26 - 14</p> <p>HD.M – Gestanzte Crimpkontakte/<i>Stamped machined crimp contacts</i> Querschnittskennzeichnung/<i>Designation of cross section</i></p> <table border="1"> <thead> <tr> <th>Kennzeichnung Designation</th> <th>Leiterquerschnitt Wire cross section</th> <th>Abisolierlänge der Litze Stripping length</th> </tr> </thead> <tbody> <tr> <td>1</td> <td>0,2 - 0,56 mm²</td> <td>3,5 mm</td> </tr> <tr> <td>2</td> <td>0,5 - 1,5 mm²</td> <td>3,5 mm</td> </tr> <tr> <td>3</td> <td>0,8 - 1,5 mm²</td> <td>3,5 mm</td> </tr> <tr> <td>4</td> <td>1,5 - 2,5 mm²</td> <td>3,5 mm</td> </tr> </tbody> </table> <p>Verpackungseinheiten/<i>Packing unit</i> Kontakte am Band/<i>Contacts on reel</i>. A= 5.000 Stück/<i>Pieces</i>, B= 4.000 Stück/<i>Pieces</i></p>	Kennzeichnung Designation	Leiterquerschnitt Wire cross section	Abisolierlänge der Litze Stripping length	1	0,2 - 0,56 mm ²	3,5 mm	2	0,5 - 1,5 mm ²	3,5 mm	3	0,8 - 1,5 mm ²	3,5 mm	4	1,5 - 2,5 mm ²	3,5 mm	<p>Stiftkontakt verzinkt <i>Pin contact tin plated</i></p> <p>Bandkontakt/Stift verzinkt <i>Reel contact/pin tin plated</i></p> <p>Stiftkontakt vergoldet <i>Pin contact gold plated</i></p> <p>Bandkontakt/Stift vergoldet <i>Reel contact/pin gold plated</i></p> <p>Buchsenkontakt verzinkt <i>Socket contact tin plated</i></p> <p>Buchsenkontakt vergoldet <i>Socket contact gold plated</i></p> <p>Bandkontakt/Buchse vergoldet <i>Reel contact/socket gold plated</i></p>	<p>1-1105000-3 2-1105000-3 4-1105000-3</p> <p>0-0164161-9 0-0166824-2</p> <p>1-1105000-2 3-1105000-2</p> <p>0-0164160-4 0-0164161-4</p> <p>1-1105001-3 2-1105001-3 4-1105001-3</p> <p>1-1105001-2 3-1105001-2</p> <p>1-0163087-1 0-0163083-7</p>	<p>0,3 – 0,56 0,5 – 1,5 1,5 – 2,5</p> <p>0,5 – 1,5 1,5 – 2,5</p> <p>0,3 – 0,56 0,8 – 1,5</p> <p>0,3 – 0,56 0,8 – 1,5</p> <p>0,3 – 0,56 0,5 – 1,5 1,5 – 2,5</p> <p>0,3 – 0,56 0,8 – 1,5</p> <p>0,3 – 0,56 0,8 – 1,5</p>
	Kennzeichnung Designation	Leiterquerschnitt Wire cross section	Abisolierlänge der Litze Stripping length															
1	0,2 - 0,56 mm ²	3,5 mm																
2	0,5 - 1,5 mm ²	3,5 mm																
3	0,8 - 1,5 mm ²	3,5 mm																
4	1,5 - 2,5 mm ²	3,5 mm																

Werkzeuge für Crimptechnik HD.M Serie/Crimping tools HD.M series

Bezeichnung Description	Bestelltext Designation	Bestell-Nr. Order No.	Querschnitt mm ² Cross section mm ²
<p>Crimpzange ohne Locator und Matrize <i>Crimping tool without locator and die</i></p>	RSZ.BAS	539635-1	
<p>Locator und Matrize <i>Locator and die</i></p>	ERGO-DIE XII	539742-2	0,2-2,5mm ² für Kontakte PN <i>for contacts PN</i>
<p>Ausdrückwerkzeug HD.M/<i>Extraction tool HD.M</i></p>	AWZG-HD.M-RSZ	0-1102855-1	alle Querschnitte <i>all cross sections</i>
<p>Eindrückwerkzeug/<i>Insertion tool</i></p>	EWZG-RSZ	0-1102855-6	unter 0,75mm ² <i>below 0,75mm²</i>

Crimpkontakte HGQ10 Serie/Crimp contacts HGQ10 series **20A**

Bezeichnung Description	Bestelltext Designation	Bestell-Nr. Order No.	Maße mm² Dimensions mm²	Werkzeug Tool
<p>Buchsenkontakt/Socket contact</p> <p>Stiftkontakt/Pin contact</p> <p>Werkstoff: Kupferlegierung Oberfläche: - verzinnt Durchgangswiderstand: ≤ 3 mΩ Crimpanschluss: - mm² 0,2 - 4,0 mm² - AWG 24 - 12</p> <p>Material: Copper alloy Finish: - tin plated Contact resistance: ≤ 3 mΩ Crimp terminal : - mm² 0,2 - 4,0 mm² - AWG 24 - 12</p> <p>Andere Oberflächen und Werkstoffe auf Anfrage Other finishes and Materials on request</p> <p>Product Spec.: 108-18027 Appl. Spec.: 114-18018</p>	Stiftkontakt verzinnt Pin contact tin plated	962966-1 962967-1 962968-1 962969-1	0,2–0,4 0,5–1,0 1,0–2,5 2,5–4,0	734285-1 734285-1 734285-2 734285-3
	Bandkontakt/Stift verzinnt Reel contact/pin tin plated	929962-1 929963-1 929964-1 929965-1	0,2–0,4 0,5–1,0 1,0–2,5 2,5–4,0	734285-1 734285-1 734285-2 734285-3
	Buchsenkontakt verzinnt Socket contact tin plated	962976-1 962977-1 962978-1 962979-1	0,2–0,4 0,5–1,0 1,0–2,5 2,5–4,0	734285-1 734285-1 734285-2 734285-3
	Bandkontakt/Buchse verzinnt Reel contact/socket tin plated	929969-1 929970-1 929971-1 929972-1	0,2–0,4 0,5–1,0 1,0–2,5 2,5–4,0	734285-1 734285-1 734285-2 734285-3

Werkzeuge für Crimptechnik HGQ10 Serie/Crimping tools HGQ10 series

Bezeichnung Description	Bestelltext Designation	Bestell-Nr. Order No.	Querschnitt mm² Cross section mm²
Ausdrückwerkzeug /Extraction tool	Extraction tool	1-1579007-8	
Crimpzange mit Locator Crimping tool with locator	Handtool	734285-11,5 mm² 734285-22,5 mm² 734285-34,0 mm²	
Halb-/Vollautomat auf Anfrage Bench and Automatic tooling on request	Safety Press SSC-2FP	1481004-7	
	Ergo Die Adapter	1579000-7	



Crimpkontakte HE/HA Serie/Crimp contacts HE/HA series

16A

Bezeichnung
Description

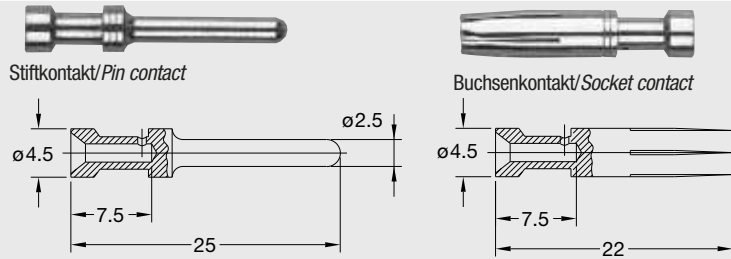

Werkstoff: Kupferlegierung
 Oberfläche:
 - hartversilbert
 - hartvergoldet
 Durchgangswiderstand: $\leq 1 \text{ m}\Omega$
 Crimpanschluss:
 - mm² 0,5 - 4,0 mm²
 - AWG 20 - 12

Material: Copper alloy
 Finish:
 - hard silver
 - hard gold
 Contact resistance: $\leq 1 \text{ m}\Omega$
 Crimp terminal :
 - mm² 0,5 - 4,0 mm²
 - AWG 20 - 12

HE/HA – Gedrehte Crimpkontakte/Screw machined crimp contacts
 Querschnittskennzeichnung/Designation of cross section

Kennzeichnung <i>Designation</i>	Leiterquerschnitt <i>Wire cross section</i>	Abisolierlänge der Litze <i>Stripping length</i>
3 Rillen/3 grooves	0,14 - 0,34 mm ²	7,5 mm
keine Rille/no groove	0,5 mm ²	7,5 mm
1 Rille/1 groove	0,75 - 1 mm ²	7,5 mm
2 Rillen/2 grooves	1,5 mm ²	7,5 mm
3 Rillen/3 grooves	2,5 mm ²	7,5 mm
keine Rille/no groove	4,0 mm ²	7,5 mm

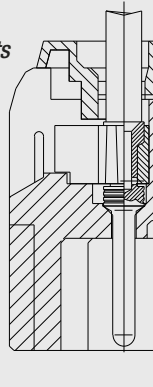

Bestelltext
Designation

Bestell-Nr.
Order No.

Maße mm²
Dimensions mm²

Stiftkontakt versilbert
Pin contact silver plated



Stiftkontakt vergoldet
Pin contact gold plated



Buchsenkontakt versilbert
Socket contact silver plated



Buchsenkontakt vergoldet
Socket contact gold plated



6-1105100-1	0,14
1-1105100-1	0,5
2-1105100-1	0,75 - 1
3-1105100-1	1,5
4-1105100-1	2,5
5-1105100-1	4,0
6-1105100-2	0,14 - 0,34
1-1105100-2	0,5
2-1105100-2	0,75 - 1
3-1105100-2	1,5
4-1105100-2	2,5
5-1105100-2	4,0
6-1105101-1	0,14
1-1105101-1	0,5
2-1105101-1	0,75 - 1
3-1105101-1	1,5
4-1105101-1	2,5
5-1105101-1	4,0
6-1105101-2	0,14 - 0,34
1-1105101-2	0,5
2-1105101-2	0,75 - 1
3-1105101-2	1,5
4-1105101-2	2,5
5-1105101-2	4,0

Werkzeuge für Crimpertechnik HE/HA Serie/Crimping tools HE/HA series

Bezeichnung
Description

Bestelltext
Designation

Bestell-Nr.
Order No.

Querschnitt mm²
Cross section mm²

Crimpzange ohne Locator und Matrize
Crimping tool without locator and die



Crimpzange mit Locator und Matrize
Crimping tool with locator and die



Locator und Matrize 0,14 - 4mm²
Locator and die 0,14 - 4mm²



Crimpzange ohne Locator
Crimping tool without locator



Locator hierzu
Locator for the tool



Ausdrückwerkzeug HE/Extraction tool HE



Eindrückwerkzeug/Insertion tool

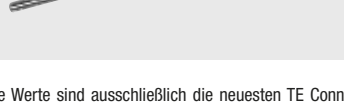

RSZ.BAS

1-1105850-8

RSZ.HE-HN.D-HVT

1-1105851-8

RSZ.LC 0,14-4 mm²

1-1105852-8

0,14-4mm²

Daniels Tool AFS

601967-1

Turnet

523168-6

0,14-4mm²

AWZG-RSZ

0-1102855-7

alle Querschnitte
all cross sections

EWZG-RSZ

0-1102855-6

Crimpkontakte HVT Serie/Crimp contacts HVT series

16A

Bezeichnung Description	Bestelltext Designation	Bestell-Nr. Order No.	Maße mm ² Dimensions mm ²																					
<p>Stiftkontakt/<i>Pin contact</i></p> <p>Buchsenkontakt/<i>Socket contact</i></p> <p>Werkstoff: Kupferlegierung Oberfläche: - hartversilbert - hartvergoldet Durchgangswiderstand: ≤ 3 mΩ Crimpanschluss: - mm² 0,13 - 4,0 mm² - AWG 20 - 12</p> <p><i>Material: Copper alloy</i> <i>Finish:</i> - hard silver - hard gold <i>Contact resistance: ≤ 3 mΩ</i> <i>Crimp terminal :</i> - mm² 0,13 - 4,0 mm² - AWG 20 - 12</p>	Stiftkontakt versilbert <i>Pin contact silver plated</i>	6-1105300-1 1-1105300-1 2-1105300-1 3-1105300-1 4-1105300-1 5-1105300-1	0,13 - 0,4 0,5 0,75 - 1,0 1,5 2,5 4,0																					
	Stiftkontakt vergoldet <i>Pin contact gold plated</i>	6-1105300-2 1-1105300-2 2-1105300-2 3-1105300-2 4-1105300-2 5-1105300-2	0,13 - 0,4 0,5 0,75 - 1,0 1,5 2,5 4,0																					
<p>HVT – Gedrehte Crimpkontakte/<i>Screw machined crimp contacts</i> Querschnittskennzeichnung/<i>Designation of cross section</i></p> <table border="1"> <thead> <tr> <th>Kennzeichnung <i>Designation</i></th> <th>Leiterquerschnitt <i>Wire cross section</i></th> <th>Abisolierlänge der Litze <i>Stripping length</i></th> </tr> </thead> <tbody> <tr><td>1</td><td>0,13 - 0,4 mm²</td><td>8 mm</td></tr> <tr><td>2</td><td>0,5 mm²</td><td>8 mm</td></tr> <tr><td>3</td><td>0,75 - 1 mm²</td><td>8 mm</td></tr> <tr><td>4</td><td>1,5 mm²</td><td>8 mm</td></tr> <tr><td>5</td><td>2,5 mm²</td><td>8 mm</td></tr> <tr><td>6</td><td>4,0 mm²</td><td>8 mm</td></tr> </tbody> </table>	Kennzeichnung <i>Designation</i>	Leiterquerschnitt <i>Wire cross section</i>	Abisolierlänge der Litze <i>Stripping length</i>	1	0,13 - 0,4 mm ²	8 mm	2	0,5 mm ²	8 mm	3	0,75 - 1 mm ²	8 mm	4	1,5 mm ²	8 mm	5	2,5 mm ²	8 mm	6	4,0 mm ²	8 mm	Buchsenkontakt versilbert <i>Socket contact silver plated</i>	6-1105301-1 1-1105301-1 2-1105301-1 3-1105301-1 4-1105301-1 5-1105301-1	0,13 - 0,4 0,5 0,75 - 1,0 1,5 2,5 4,0
	Kennzeichnung <i>Designation</i>	Leiterquerschnitt <i>Wire cross section</i>	Abisolierlänge der Litze <i>Stripping length</i>																					
1	0,13 - 0,4 mm ²	8 mm																						
2	0,5 mm ²	8 mm																						
3	0,75 - 1 mm ²	8 mm																						
4	1,5 mm ²	8 mm																						
5	2,5 mm ²	8 mm																						
6	4,0 mm ²	8 mm																						
	Buchsenkontakt vergoldet <i>Socket contact gold plated</i>	6-1105301-2 1-1105301-2 2-1105301-2 3-1105301-2 4-1105301-2 5-1105301-2	0,13 - 0,4 0,5 0,75 - 1,0 1,5 2,5 4,0																					

Werkzeuge für Crimptechnik HVT Serie/Crimping tools HVT series

Bezeichnung Description	Bestelltext Designation	Bestell-Nr. Order No.	Querschnitt mm ² Cross section mm ²
Crimpzange ohne Locator und Matrize <i>Crimping tool without locator and die</i>	RSZ.BAS	1-1105850-8	
Crimpzange mit Locator und Matrize <i>Crimping tool with locator and die</i>	RSZ.HE-HN.D-HVT	1-1105851-8	
Locator und Matrize 0,14 – 4mm ² <i>Locator and die 0,14 – 4mm²</i>	RSZ.LC 0,14-4 mm ²	1-1105852-8	0,14-4mm ²
Crimpzange ohne Locator <i>Crimping tool without locator</i>	Daniels Tool AFS	601967-1	
Locator hierzu <i>Locator for the tool</i>	Turnet	523168-5	0,14-4mm ²
Ausdrückwerkzeug HE/ <i>Extraction tool HE</i>	AWZG-RSZ	0-1102855-3	alle Querschnitte <i>all cross sections</i>
Eindrückwerkzeug/ <i>Insertion tool</i>	EWZG-RSZ	0-1102855-6	

Crimpkontakte HSK Serie/Crimp contacts HSK series

40A

Bezeichnung Description	Bestelltext Designation	Bestell-Nr. Order No.	Maße mm ² Dimensions mm ²																		
<p>Stiftkontakt/<i>Pin contact</i></p> <p>Buchsenkontakt/<i>Socket contact</i></p> <p>Werkstoff: Kupferlegierung Oberfläche: - hartversilbert - hartvergoldet Durchgangswiderstand: ≤ 3 mΩ Crimpanschluss: - mm² 1,5 - 10,0 mm² - AWG 16 - 8</p> <p>Material: Copper alloy Finish: - hard silver - hard gold Contact resistance: ≤ 3 mΩ Crimp terminal : - mm² 1,5 - 10,0 mm² - AWG 16 - 8</p>	<p>Stiftkontakt versilbert <i>Pin contact silver plated</i></p> <p>Stiftkontakt vergoldet <i>Pin contact gold plated</i></p> <p>Buchsenkontakt versilbert <i>Socket contact silver plated</i></p> <p>Buchsenkontakt vergoldet <i>Socket contact gold plated</i></p>	<p>1-1108757-1 2-1108757-1 3-1108757-1 4-1108757-1 5-1108757-1</p> <p>auf Anfrage/ <i>on request</i></p> <p>1-1108756-1 2-1108756-1 3-1108756-1 4-1108756-1 5-1108756-1</p> <p>auf Anfrage/ <i>on request</i></p>	<p>1,5 2,5 4 6 10</p> <p>1,5 2,5 4 6 10</p>																		
<p>HSK – Gedrehte Crimpkontakte/<i>Screw machined crimp contacts</i> Querschnittskennzeichnung/<i>Designation of cross section</i></p> <table border="1"> <thead> <tr> <th>Kennzeichnung <i>Designation</i></th> <th>Leiterquerschnitt <i>Wire cross section</i></th> <th>Abisolierlänge der Litze <i>Stripping length</i></th> </tr> </thead> <tbody> <tr> <td>4</td> <td>1,5 mm²</td> <td>11,5 mm</td> </tr> <tr> <td>5</td> <td>2,5 mm²</td> <td>11,5 mm</td> </tr> <tr> <td>6</td> <td>4 mm²</td> <td>11,5 mm</td> </tr> <tr> <td>7</td> <td>6 mm²</td> <td>11,5 mm</td> </tr> <tr> <td>8</td> <td>10 mm²</td> <td>11,5 mm</td> </tr> </tbody> </table>	Kennzeichnung <i>Designation</i>	Leiterquerschnitt <i>Wire cross section</i>	Abisolierlänge der Litze <i>Stripping length</i>	4	1,5 mm ²	11,5 mm	5	2,5 mm ²	11,5 mm	6	4 mm ²	11,5 mm	7	6 mm ²	11,5 mm	8	10 mm ²	11,5 mm			
Kennzeichnung <i>Designation</i>	Leiterquerschnitt <i>Wire cross section</i>	Abisolierlänge der Litze <i>Stripping length</i>																			
4	1,5 mm ²	11,5 mm																			
5	2,5 mm ²	11,5 mm																			
6	4 mm ²	11,5 mm																			
7	6 mm ²	11,5 mm																			
8	10 mm ²	11,5 mm																			

Werkzeuge für Crimptechnik HSK Serie/Crimping tools HSK series

Bezeichnung Description	Bestelltext Designation	Bestell-Nr. Order No.	Querschnitt mm ² Cross section mm ²
<p>Crimpzange ohne Locator und Matrize <i>Crimping tool without locator and die</i></p>	RSZ.BAS	1-1105850-8	
<p>Matrize <i>die</i></p>	HSK.RSZ.LC 0,75-2,5 mm ² HSK.RSZ.LC 4-10 mm ²	0-1102789-1 0-1102790-1	
<p>Crimpzange ohne Locator <i>Crimping tool without locator</i></p>	Daniels Tool AFS	601967-1	
<p>Locator hierzu <i>Locator for the tool</i></p>	Turnet	523168-7	1,5-10mm ²
<p>Ausdrückwerkzeug HSK <i>Extraction tool HSK</i></p>	AWZG-HSK-RSZ	0-1102855-8	alle Querschnitte <i>all cross sections</i>
<p>Eindrückwerkzeug/<i>Insertion tool</i></p>	EWZG-RSZ	0-1102855-6	

Crimpkontakte HSM Serie/Crimp contacts HSM series

40A

Bezeichnung
Description



Stiftkontakt/*Pin contact*

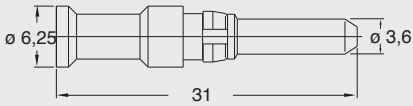

Buchsenkontakt/*Socket contact*

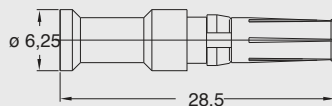

Werkstoff: Kupferlegierung
Oberfläche:
- hartversilbert
- hartvergoldet
Durchgangswiderstand: $\leq 3 \text{ m}\Omega$
Crimpanschluss:
- mm² 0,75 - 10,0 mm²
- AWG 20 - 6

Material: Copper alloy
Finish:
- hard silver
- hard gold
Contact resistance: $\leq 3 \text{ m}\Omega$
Crimp terminal:
- mm² 0,75 - 10,0 mm²
- AWG 20 - 6

HSM – Gedrehte Crimpkontakte/*Screw machined crimp contacts*
Querschnittskennzeichnung/*Designation of cross section*

Kennzeichnung <i>Designation</i>	Leiterquerschnitt <i>Wire cross section</i>	Abisolierlänge der Litze <i>Stripping length</i>
3	0,75 mm ²	10 mm
4	1,5 mm ²	10 mm
5	2,5 mm ²	10 mm
6	4 mm ²	10 mm
7	6 mm ²	10 mm
8	10 mm ²	10 mm

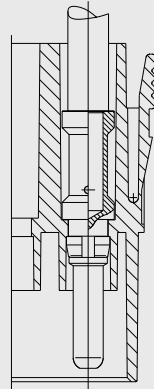

Bestelltext
Designation

Stiftkontakt versilbert
Pin contact silver plated



Bestell-Nr.
Order No.

- 1-1105250-1
- 2-1105250-1
- 3-1105250-1
- 4-1105250-1
- 5-1105250-1
- 6-1105250-1

Maße mm²
Dimensions mm²

- 0,75-1
- 1,5
- 2,5
- 4
- 6
- 10

Buchsenkontakt versilbert
Socket contact silver plated



- 1-1105251-1
- 2-1105251-1
- 3-1105251-1
- 4-1105251-1
- 5-1105251-1
- 6-1105251-1

- 0,75-1
- 1,5
- 2,5
- 4
- 6
- 10

Werkzeuge für Crimptechnik HSM Serie/Crimping tools HSM series

Bezeichnung
Description

Crimpzange ohne Locator und Matrize
Crimping tool without locator and die



RSZ.BAS

1-1105850-8

Matrize für HSM-Kontakte
die for HSM-contacts



HSM.RSZ.LC 0,75-2,5 mm²
HSM.RSZ.LC 4-10 mm²

1-1105870-8
2-1105870-8

Ausdrückwerkzeug HSM
Extraction tool HSM



AWZG-HSM-RSZ

0-1102855-4

Eindrückwerkzeug/*Insertion tool*



EWZG-RSZ

0-1102855-6

Querschnitt mm²
Cross section mm²

alle Querschnitte
all cross sections

Crimpkontakte HSS Serie/Crimp contacts HSS series

63A

Bezeichnung Description	Bestelltext Designation	Bestell-Nr. Order No.	Maße mm ² Dimensions mm ²												
<p>Stiftkontakt/<i>Pin contact</i></p> <p>Buchsenkontakt/<i>Socket contact</i></p> <p>Werkstoff: Kupferlegierung Oberfläche: - hartversilbert, 2,5 - 16 mm² - hartvergoldet, 6 - 16 mm² Durchgangswiderstand: ≤ 1 mΩ Crimpanschluss: - mm² 2,5 - 16 mm² - AWG 14 - 4</p> <p>Material: Copper alloy Finish: - hard silver, 2,5 - 16 mm² - hard gold, 6 - 16 mm² Contact resistance: ≤ 1 mΩ Crimp terminal : - mm² 2,5 - 16 mm² - AWG 14 - 4</p> <p>HSS – Gedrehte Crimpkontakte/<i>Screw machined crimp contacts</i> Querschnittskennzeichnung/<i>Designation of cross section</i></p> <table border="1"> <thead> <tr> <th>Kennzeichnung Designation</th> <th>Leiterquerschnitt Wire cross section</th> <th>Abisolierlänge der Litze Stripping length</th> </tr> </thead> <tbody> <tr> <td></td> <td>6,0 mm²</td> <td>12 mm</td> </tr> <tr> <td></td> <td>10 mm²</td> <td>12 mm</td> </tr> <tr> <td></td> <td>16 mm²</td> <td>12 mm</td> </tr> </tbody> </table>	Kennzeichnung Designation	Leiterquerschnitt Wire cross section	Abisolierlänge der Litze Stripping length		6,0 mm ²	12 mm		10 mm ²	12 mm		16 mm ²	12 mm	<p>Stiftkontakt versilbert <i>Pin contact silver plated</i></p> <p>Stiftkontakt vergoldet <i>Pin contact gold plated</i></p> <p>Buchsenkontakt versilbert <i>Socket contact silver plated</i></p> <p>Buchsenkontakt vergoldet <i>Socket contact gold plated</i></p>	<p>3-1105150-1 4-1105150-1 5-1105150-1</p> <p>3-1105150-2 4-1105150-2 5-1105150-2</p> <p>3-1105151-1 4-1105151-1 5-1105151-1</p> <p>3-1105151-2 4-1105151-2 5-1105151-2</p>	<p>6,0 10 16</p> <p>6,0 10 16</p> <p>6,0 10 16</p> <p>6,0 10 16</p>
Kennzeichnung Designation	Leiterquerschnitt Wire cross section	Abisolierlänge der Litze Stripping length													
	6,0 mm ²	12 mm													
	10 mm ²	12 mm													
	16 mm ²	12 mm													

Werkzeuge für Crimptechnik HSS Serie/Crimping tools HSS series

Bezeichnung Description	Bestelltext Designation	Bestell-Nr. Order No.	Querschnitt mm ² Cross section mm ²
<p>Crimpzange ohne Crimpbacken <i>Crimping tool without crimping jaws</i></p>	HSS-CSZ.2,5-70mm ²	1-1105653-8	2,5-70mm ²
<p>Crimpbacken für HSM, HSL, HSS <i>Crimping jaws for HSM, HSL, HSS</i></p>	CB-HSS-CSZ.6mm ² CB-HSS-CSZ.10mm ² CB-HSS-CSZ.16mm ²	2-1105653-8 3-1105653-8 4-1105653-8	2,5-16mm ²
<p>Crimpzange ohne Locator und Matrize <i>Crimping tool without locator and die</i></p>	RSZ.BAS	1-1105850-8	
<p>Locator <i>Locator</i></p>	RSZ.LC 6+25 mm ² RSZ.LC 10+16 mm ²	1-1105652-8 2-1105652-8	6+25mm ² 10+16mm ²
<p>Ausdrückwerkzeug HSS/AIR <i>Extraction tool HSS/AIR</i></p>	AWZG-HSS-RSZ	0-1102855-5	alle Querschnitte all cross sections

Crimphülsen max. 150 A/Crimping sleeves max. 150 A

Crimphülsen für Kontaktserie HF-06/Crimping sleeves for contact series HF-06

Bezeichnung Description	Bestelltext Designation	Bestell-Nr. Order No.
Crimphülsen für Stift-/Buchsen- - Schrumpfschlauch - Crimphülse Crimp barrel for pin-/socket side - shrink tube - crimp barrel	CH.06mm ² -SW17	0-1110952-1
	CH.10mm ² -SW17	0-1110952-2
	CH.16mm ² -SW17	0-1110952-3
	CH.25mm ² -SW17	0-1110952-5
	CH.35mm ² -SW17	0-1110952-7
	CH.50mm ² -SW17	0-1110952-9
	CH.70mm ² -SW17	1-1110952-0
	HF.06.Sti.	0-1110948-1
	HF.06.Bu.	0-1110949-1

Crimphülsen max. 350 A/Crimping sleeves max. 350 A

Crimphülsen für Kontaktserie HF-13/Crimping sleeves for contact series HF-13

Crimphülsen für Stift-/Buchsen- bestehend aus - Schrumpfschlauch - Crimphülse - Adapter Crimp barrel for pin-/socket side - shrink tube - crimp barrel - adapter	CH.50mm ² -13/16mm	0-1110953-5
	CH.70mm ² -13/16mm	0-1110953-6
	CH.95mm ² -13/16mm	0-1110953-7
	CH.105mm ² -13/16mm	0-1110953-8
	CH.120mm ² -13/16mm	0-1110953-9
	CH.150mm ² -13/16mm	1-1110953-1

Passendes Verarbeitungswerkzeug/suitable tools

Crimpzange ohne Crimpbacken Crimping tool without crimping jaws		HSS-CSZ.2,5-70mm ²	1-1105653-8
Crimpbacken für HSL, HSS Crimping jaws for HSL, HSS		CB-HSS-CSZ.6mm ² CB-HSS-CSZ.10mm ² CB-HSS-CSZ.16mm ² CB-HSS-CSZ.25mm ² CB-HSS-CSZ.35mm ² CB-HSS-CSZ.50mm ² CB-HSS-CSZ.70mm ²	2-1105653-8 3-1105653-8 4-1105653-8 5-1105653-8 6-1105653-8 7-1105653-8 8-1105653-8
Hydraulische Crimpzange Hydraulic crimping tool		CZ-HF.60.M	0-1110956-1
Presseinsätze dies		SET-50-150mm ² 150mm ² -KZ22 120mm ² -KZ20 95mm ² -KZ18 70mm ² -KZ16 50mm ² -KZ14	0-1110956-7 0-1110956-6 0-1110956-5 0-1110956-4 0-1110956-3 0-1110956-2

Koax-Kontakte/Coax-contacts

Koax-Kontakte RG58/RG59

Wellenimpedanz	50 Ω / 75 Ω
spezifischer Widerstand	max. 2mΩ
Ziehkraft	min. 1N
Zugfestigkeit	min. 50N
Spannungsfestigkeit	1000VAC über 1min
Isolationswiderstand	200 mΩ nach 1min Betrieb
Steckkraft	max. 1,5N
Werkstoff	Kupferlegierung
Kontaktfläche	vergoldet
Druckhülsoberfläche	versilbert
Crimpanschluß	

Coax-contacts RG58/RG59

Wave impedance	50 Ω / 75 Ω
Specific resistance	max. 2m(
Unmating force	min. 1N
Tensile strength	min. 50N
Dielectric withstanding voltage	1000VAC over/during? 1min
Insulation resistance	200 mΩ after 1min operation
Mating force	max. 1,5N
Material	copper alloy
contact surface	gold-plated
Ferrule surface	silver-plated
Crimp termination	

Bezeichnung Description	Bestelltext Designation	Bestell-Nr. Stifteinsatz Male insert	Order No. Buchseinsatz Female insert
Koax Crimpkontakte/Coax Crimp tcontacts 	Stiftkontakt Pin contact	KX-RG.58.Sti KX-RG.59.Sti	1-1105350-1 2-1105350-1
	Buchsenkontakt Socket contact	KX-RG.58.Bu KX-RG.59.Bu	1-1105351-1 2-1105351-1

Koax-Kontakte

Wellenimpedanz	75 Ω
Anschlußart	
Innenleiter	Löt
Außenleiter	Klemm
Kabeldurchmesser	
Innenleiter	0,8/1,44/2,8
Außenleiter	6,1/10,0/10,7

Coax-contacts

Wave impedance	75 Ω
Type of termination	
internal conductor	solder
outside conductor	clamp
Dimensions of the wire	
internal conductor	0,8/1,44/2,8
outside conductor	6,1/10,0/10,7

Kabelabmasse Cable measures	Innen ø Inner ø	Schirm ø Braid ø	Außen ø Outer ø
KX.RG.58	0,81	2,95	4,95
KX.RG.59	0,64	3,71	6,15
KX.VT.0,8/3,5	0,8	3,5	6,1
KX.VT.1,4/6,3	1,4	6,3	10,0
KX.VT.3,0/7,3	3,0	7,3	10,8

Bezeichnung Description	Bestelltext Designation	Bestell-Nr./Order No. Stifteinsatz Male insert	Buchseinsatz Female insert
Koax Crimpkontakte/Coax Crimp tcontacts 	Stiftkontakt Pin contact	KX.VT.Sti.0,8/3,5/6,1 KX.VT.Sti.1,4/6,3/10,0 KX.VT.Sti.3,0/7,3/10,8	0-1108600-1 0-1108628-1 0-1108616-1
	Buchsenkontakt Socket contact	KX.VT.Bu.0,8/3,5/6,1 KX.VT.Bu.1,4/6,3/10,0 KX.VT.Bu.3,0/7,3/10,8	0-1108601-1 0-1108629-1 0-1108617-1

Werkzeuge für Crimptechnik Koax/Crimping tools Coax

Bezeichnung Description	Bestelltext Designation	Bestell-Nr./Order No.	Maße mm² Dimensions mm²
Crimpzange Koax/Crimping tool Coax	KX-CZ.58	0-0045740-2	
Crimpzange Koax/Crimping tool Coax	KX-CZ.59 +Matrize/Die	69710-1 69675-1	
Ausdrückwerkzeug KX RG 58/59 Extraction tool KX RG 58/59	KX-AWZG.58/59	0-0305183-8	
Ausdrückwerkzeug KX-VT Extraction tool KX-VT	KX-VT-AWZG	1-1105752-8	



Kontakte (Optik) HD-LWL Serie/Contacts (Optics) HD-LWL series

LWL-Kontakte (Optik)





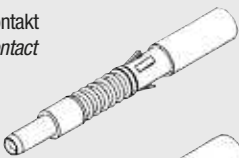
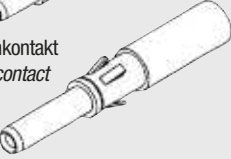
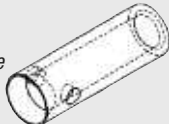

Kontakt-Werkstoff Ms,
Zentrierhülse-Werkstoff
Zusammenstellung: verzinkt und rostfreier Stahl
Thermoplast
kurzer Kontakt mit Zentrierhülse
langer Kontakt
Einfügungsdämpfung <2dB
Steckhäufigkeit 50 Zyklen
Betriebstemperatur -20°C - +80°C
Kabelhaltekraft im Kontakt [N] min 30
Kontakthaltekraft im Modul min 40
Leitungstyp 1mm Plastik-Lichtwellenleiter
mit 2,2mm Mantel
Crimpanschluß

LWL-contacts (optics)

Contact-material Ms,
Material of centering ferrule
assembly: tin-plated and stainless steel
thermoplastics
short contact with centering ferrule
long contact
insertion loss <2dB
mating frequency 50 cycles
Operating temperature -20°C - +80°C
holding power of the cable in the contact [N] min 30
contact retention force in the module min 40
cable type 1mm plastic-fiber optics
with 2,2mm sleeve
Crimp connection

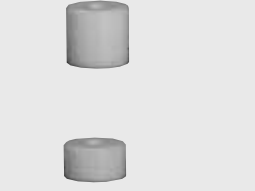
Bezeichnung Description	Zentrierhülse Alignment sleeve	Stifteinsatz Male insert	Buchseinsatz Female insert
 <p>Stiftkontakt Pin contact</p>  <p>Buchsenkontakt mit Zentrierhülse Socket contact with alignment sleeve</p>  <p>Zentrierhülse für kurzen Kontakt Alignment sleeve for short contact</p>	 <p>Stiftkontakt Pin contact</p>  <p>Buchsenkontakt Socket contact</p>  <p>Zentrierhülse Alignment sleeve</p>	0-0216341-1	0-0216342-1
	0-1102921-1		

Werkzeuge für Crimptechnik Koax/Crimping tools Coax

Bezeichnung Description	Bestelltext Designation	Bestell-Nr./ Order No.	Maße mm² Dimensions mm²
Crimpzange/Crimping tool		Crimpzange	0-0090364-2
Faserstripper/Cable stripper		Faserstripper	0-0501198-1
Schneidlehre o. Abb./Cutting gauge		Schneidlehre	0-0100281-1
Rückschmelzofen/Hot melting Unit		Rückschmelzofen	0-0734423-1
Schmelzlehre lange Kontakte/Melting gauge long contact		Schmelzlehre lange Kontakte	0-0100606-2
Schmelzlehre kurze Kontakte/Melting gauge short contact		Schmelzlehre kurze Kontakte	0-0100281-2
Ausdrückwerkzeug HD/Extraction tool HD		AWZG-HD.M-RSZ	0-1102855-1
Eindrückwerkzeug/Insertion tool		EWZG-RZS	0-1102855-6

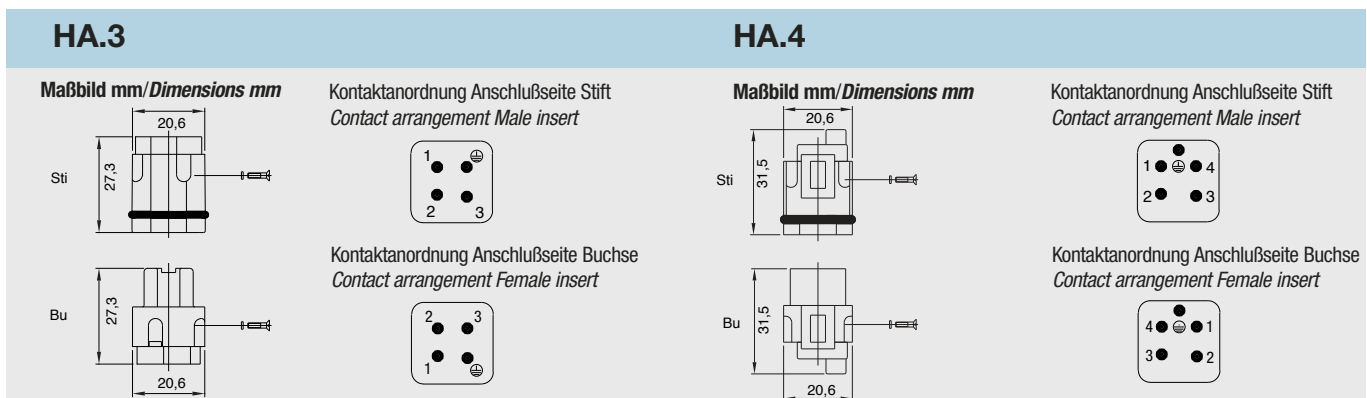

HA.3/HA.4 Kontakteinsätze/Contact inserts	Baugröße/Size 1
Schraubanschluss	Kontaktzahlen No. of contacts
Screw terminal	3/4 +
	250 V/10 A

Bezeichnung Description	Bestelltext Designation	Bestell-Nr./Order No.	
		Stifteinsatz Male insert	Buchseinsatz Female insert
<p>Stifteinsatz/Male insert</p> <p style="text-align: right;">Buchseinsatz/Female insert</p> <p>HA.3 Kontakteinsätze/Contact inserts</p> <p>Schraubanschluss/Screw terminal</p> <div style="display: flex; justify-content: space-around;"> </div>	<p>HA.3.Sti.S</p> <p>HA.3.Bu.S</p>	<p>1-1103400-1</p> <p>1-1103401-1</p>	
<p>HA.4 Kontakteinsätze/Contact inserts</p> <p>Schraubanschluss/Screw terminal</p> <div style="display: flex; justify-content: space-around;"> </div>	<p>HA.4.Sti.S</p> <p>HA.4.Bu.S</p>	<p>1-1103402-1</p> <p>1-1103403-1</p>	



Verbindlich für Toleranzen der Abmessungen und technische Werte sind ausschließlich die neuesten TE Connectivity Kundenzeichnungen bzw. Produkt-Spezifikationen, die Sie auf Anfrage erhalten.
 All specifications subject to change. Consult TE Connectivity for latest design specifications.

HE-Q.5 Kontakteinsätze/Contact inserts	Baugröße/Size 1
Crimpanschluss für gedrehte HE Crimpkontakte	Kontaktzahlen No. of contacts
Crimp terminal for screw machined HE crimp contacts	5 +
	400 V/16 A

Bezeichnung Description		Bestelltext Designation	Bestell-Nr./Order No.	
Stifteinsatz/Male insert	Buchseinsatz/Female insert		Stifteinsatz Male insert	Buchseinsatz Female insert
<p>Crimpanschluss/Crimp terminal</p> 		HE-Q.5.Sti.C	0-1102195-1	
		HE-Q.5.Bu.C		0-1102194-1

Passende Crimpkontakte siehe Seite 37, Passende Crimpwerkzeuge siehe Seite 37
 Suitable Crimp contacts see page 37, Suitable Crimping tools see page 37

Maßbild mm
Dimensions mm

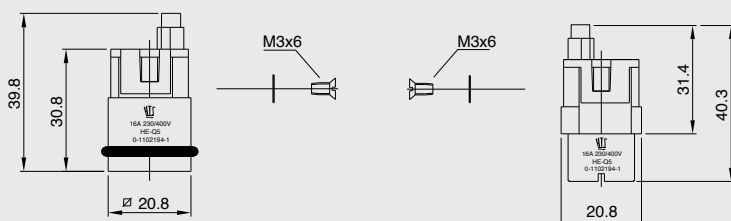

Kontaktanordnung Anschlußseite Stift
Contact arrangement Male insert



Kontaktanordnung Anschlußseite Buchse
Contact arrangement Female insert



HN.D.7/HN.D.8 Kontakteinsätze/Contact inserts **Baugröße/Size 1**

Crimpanschluss für gedrehte HN.D Crimpkontakte

Kontaktzahlen
No. of contacts

Crimp terminal for screw machined HN.D crimp contacts

7/8 +

250 V/10 A / 42* V/10 A

Bezeichnung Description	Bestelltext Designation	Bestell-Nr./Order No.	
		Stifteinsatz Male insert	Buchseinsatz Female insert
Stifteinsatz/Male insert Buchseinsatz/Female insert Crimpanschluss/Crimp terminal 	HN.D.7.Sti.C.250V HN.D.7.Sti.C.42V* HN.D.7.Bu.C.250V HN.D.7.Bu.C.42V* HN.D.8.Sti.C.42V* HN.D.8.Bu.C.42V*	2-1103100-3 2-1103102-3 2-1103104-3	 2-1103101-3 2-1103103-3 2-1103105-3
<p>*Einschränkung der Nennspannung (42 V) nur bei Verwendung von Metallgehäusen wie Serie HA.3. Bei Verwendung von Kunststoffgehäusen (Serie HD.7) beträgt die Nennspannung 250 V. Limited nominal Voltage (42 V) only in combination with metal housing series as HA.3 series. When used with nylon housings (Series HD.7) the rated voltage is 250 V.</p>			

Passende Crimpkontakte siehe Seite 34, Passende Crimpwerkzeuge siehe Seite 34
 Suitable Crimp contacts see page 34, Suitable Crimping tools see page 34

Maßbild mm
Dimensions mm

Isolierhülle nur für Variante 250V
Insolation only for 250V insert

Kontaktanordnung Anschlußseite Stift
Contact arrangement Male insert

Kontaktanordnung Anschlußseite Buchse
Contact arrangement Female insert

HD.7 Kontakteinsätze/Contact inserts

Baugröße/Size 1

Crimpanschluss für gestanzte HD.M Crimpkontakte

**Kontaktzahlen
No. of contacts**

Crimp terminal for stamped HD.M crimp contacts

7/8 +

250 V/10 A / 42V/10A

Bezeichnung Description	Bestelltext Designation	Bestell-Nr./Order No.	
		Stifteinsatz Male insert	Buchseinsatz Female insert
<p>Stifteinsatz/Male insert</p> <p>Buchseinsatz/Female insert</p> <p>Crimpanschluss/Crimp terminal</p>	<p>HD.7.Sti.C.250V HD.7.Sti.C.42V*</p>	<p>2-1103000-3 2-1103002-3</p>	
	<p>HD.7.Bu.C.250V HD.7.Bu.C.42V*</p>		<p>2-1103001-3 2-1103003-3</p>
	<p>HD.8.Sti.C.42V*</p>	<p>0-1102892-1</p>	
	<p>HD.8.Bu.C.42V*</p>		<p>0-1102893-1</p>

*Einschränkung der Nennspannung (42 V) nur bei Verwendung von Metallgehäusen wie Serie HA.3. Bei Verwendung von Kunststoffgehäusen (Serie HD.7) beträgt die Nennspannung 250 V.
*Limited nominal Voltage (42 V) only in combination with metal housing series as HA.3 series.
 When used with nylon housings (Series HD.7) the rated voltage is 250 V.*

Passende Crimpkontakte siehe Seite 35, Passende Crimpwerkzeuge siehe Seite 35
 Suitable Crimp contacts see page 35, Suitable Crimping tools see page 35

Maßbild mm
 Dimensions mm

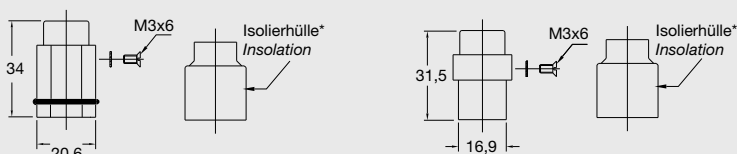

Isolierhülle nur für Variante 250V
 Insolation only for 250V insert

Kontaktanordnung Anschlußseite Stift
 Contact arrangement Male insert

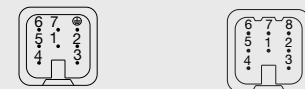

Kontaktanordnung Anschlußseite Buchse
 Contact arrangement Female insert

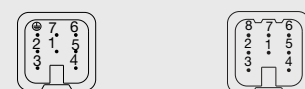

HA.3 Gehäuse/Housings

Baugröße/Size 1







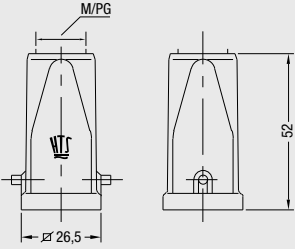

Pulverbeschichtet, silbergrau

Powder-coated, silver-grey

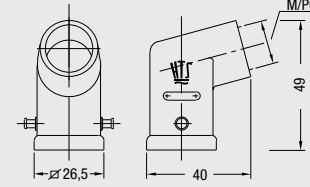
*Zubehör siehe Seite 189
*Accessories see page 189

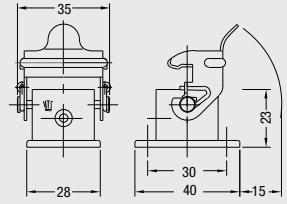
Längsbügel am Unterteil/Side clip at housing bottom

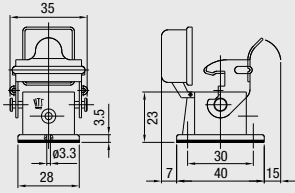
(IP 44) IP 65*

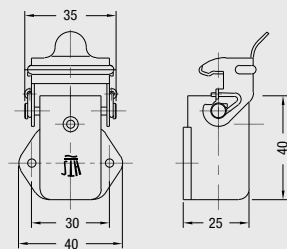
Bezeichnung Description	Metr.	PG	Bestelltext Designation	Bestell-Nr. Order No.
Steckergehäuse: Kabeleingang oben Hood: Top entry  	M16 M20	11	HA.3.STO.1.11.Z HA.3.STO.1.M16.Z HA.3.STO.1.M20.Z Mit Korrosionsschutz With corrosion protection	1-1102101-7 0-1106405-1 0-1106405-3
Steckergehäuse: Kabeleingang seitlich Hood: Side entry  	M16 M20	11	HA.3.STW.1.11.Z HA.3.STW.1.M16.Z HA.3.STW.1.M20.Z	1-1102103-7 0-1106406-1 0-1106406-3
Anbaugehäuse: Kabeleingang unten Surface mounted housing: Bottom entry   <p>Montageausschnitt/Panel cut-out 22 x22</p>			HA.3.AG-LB Mit Korrosionsschutz With corrosion protection HA-K.3.AG-LB	1-1102105-2 2-1102105-2
Anbaugehäuse: Kabeleingang unten Surface mounted housing: Bottom entry   <p>Montageausschnitt/Panel cut-out 22 x22</p>			HA.3.AGD-LB	1-1102106-2
Winkel-Anbaugehäuse: Kabeleingang unten Surface mounted housing: Bottom entry   <p>Montageausschnitt/Panel cut-out ø 20</p>			HA.3.AGW-LB Mit Korrosionsschutz With corrosion protection HA-K.3.AGW-LB	1-1102107-2 2-1102107-2

Passende Kabelverschraubungen ab Seite 188/Suitable Cable fittings from page 188

HA.3 Gehäuse/Housings

Baugröße/Size 1

Pulverbeschichtet, silbergrau

Powder-coated, silver-grey

*Zubehör siehe Seite 189
*Accessories see page 189

Längsbügel am Unterteil/Side clip at housing bottom

(IP 44) IP 65*

Bezeichnung Description	Metr.	PG	Bestelltext Designation	Bestell-Nr. Order No.
<p>Sockelgehäuse: Kabeleingang seitlich <i>Surface mounted housing: Side entry</i></p>	M16 M20	11 11	HA.3.SG-LB.1.11.G HA.3.SG-LB.1.11.Z HA.3.SG-LB.1.M16.Z HA.3.SG-LB.1.M20.G	1-1102110-2 1-1102109-2 0-1106404-1 0-1106404-3
<p>Kupplungsgehäuse: Kabeleingang unten <i>Cable-to-cable hood: Bottom entry</i></p>	M16	11	HA.3.KD0-LB.1.11.Z HA.3.KD0-LB.1.M16.Z	1-1102112-2 0-1106403-1
<p>Kupplungsgehäuse mit Deckel <i>Cable-to-cable hood with cover</i></p>		11	HA.3.KD0D-LB.1.11Z	1-1108759-2
<p>Einschraubgehäuse: Kabeleingang unten <i>Surface mounted housing: Bottom entry</i></p>	M20	16	HA.3.EG-LB/A.1.16.Z HA.3.EG-LB/M.1.20.Z	1-1102114-2 0-1102874-1

Passende Kabelverschraubungen ab Seite 188/Suitable Cable fittings from page 188

HG-Q.5 Gehäuse/Housings



Baugröße/Size 1

Kunststoff, glasfaserverstärkt, weiß
BL = schwarz

Plastic, glass-fibre reinforced, white
BL = black

Längsbügel am Unterteil/Side clip at housing bottom

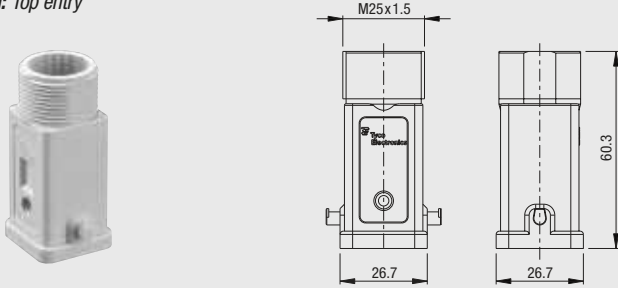
IP 65

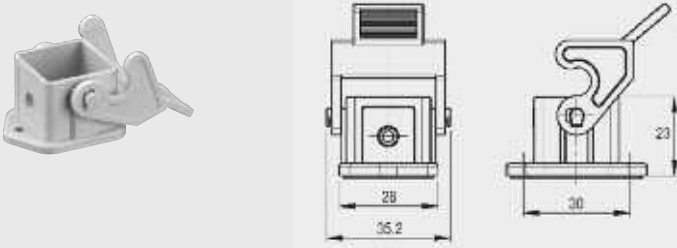
Bezeichnung Description	Metr.	PG	Bestelltext Designation	Bestell-Nr. Order No.
<p>Steckergehäuse: Kabeleingang oben <i>Hood: Top entry</i></p> 	M25 M25		HG-Q.5.STO.1.M25 HG-Q.5.STO.1.M25.BL	0-1103169-1 0-1103169-2
<p>Steckergehäuse: Kabeleingang seitlich <i>Hood: Side entry</i></p> 	M25 M25		HG-Q.5.STW.1.M25 HG-Q.5.STW.1.M25.BL	0-1103170-1 0-1103170-2
<p>Anbaugeschäuse: Kabeleingang unten <i>Surface mounted housing: Bottom entry</i></p>  <p>Montageausschnitt/Panel cut-out 22 x22</p>			HG-Q.5.AG HG-Q.5.AG.BL	0-1103171-1 0-1103171-2

Passende Hut-Verschraubungen auf Seite 59/Suitable gland fittings from page 59

HG-Q.5 Gehäuse/Housings

Baugröße/Size 1

Kunststoff, glasfaserverstärkt, weiß
BL = schwarz

Plastic, glass-fibre reinforced, white
BL = black

Längsbügel am Unterteil/Side clip at housing bottom

IP 65

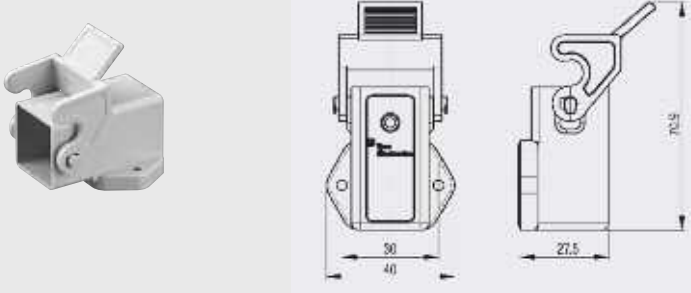
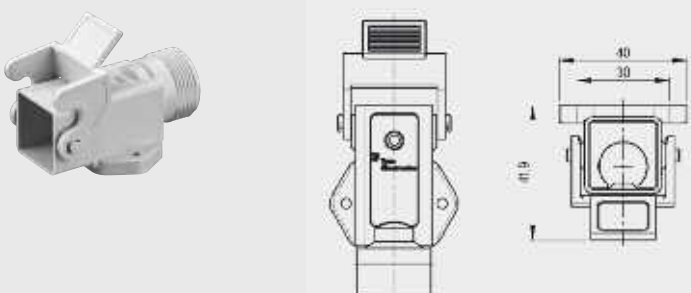
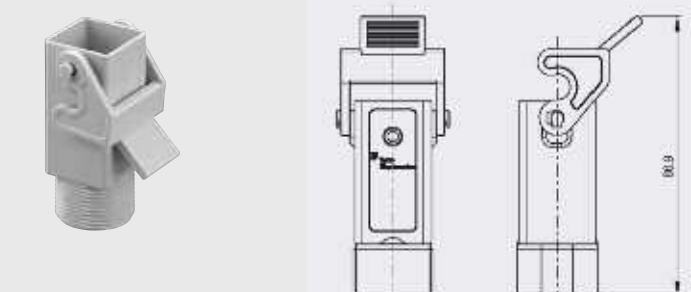
Bezeichnung Description	Metr.	PG	Bestelltext Designation	Bestell-Nr. Order No.
<p>Winkel-Anbaugehäuse: Kabeleingang unten <i>Surface mounted housing: Bottom entry</i></p>  <p>Montageausschnitt/Panel cut-out \varnothing 20</p>			<p>HG-Q.5.AGW HG-Q.5.AGW.BL</p>	<p>0-1103172-1 0-1103172-2</p>
<p>Sockelgehäuse: Kabeleingang seitlich <i>Surface mounted housing: Side entry</i></p> 	<p>M25 M25</p>		<p>HG-Q.5.SG.1.M25 HG-Q.5.SG.1.M25.BL</p>	<p>0-1103173-1 0-1103173-2</p>
<p>Kupplungsgehäuse: Kabeleingang oben, Standard Bauform <i>Cable-to-cable hood: Top entry, Standard construction</i></p> 	<p>M25 M25</p>		<p>HG-Q.5.KD0.1.M25 HG-Q.5.KD0.1.M25.BL</p>	<p>0-1103174-1 0-1103174-2</p>

Passende Hut-Verschraubungen auf Seite 59/Suitable gland fittings from page 59

HIP.3/4, HIP-K.3/4, EMV-K.3/4 Gehäuse/Housings

Baugröße/Size 1

HIP: Druckdicht, silbergrau, **HIP-K:** Korrosionsgeschützt, schwarz





EMV-K: Schutz gegen elektromagnetische Beeinflussung, druckdicht, korrosionsgeschützt, schwarz

HIP: Pressure-tight, silver-grey, **HIP-K:** Housings corrosion-resistant, black

EMV-K: Protection against electro-magnetic interference, pressure-tight, housings corrosion-resistant, black

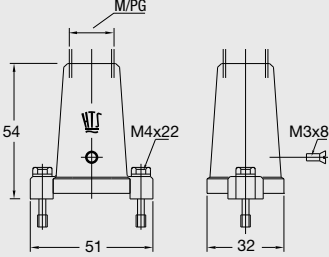
Schraubverriegelung am Oberteil/Screw lock on hood

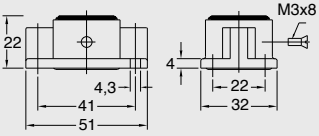
IP 68

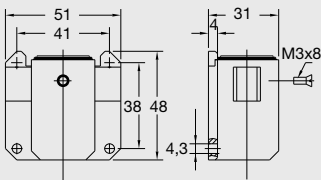
Bezeichnung Description	Metr.	PG	Bestelltext Designation	Bestell-Nr. Order No.		
<p>Steckergehäuse: Kabeleingang oben <i>Hood: Top entry</i></p>  	M16	11	<p>HIP HIP.3/4.STO.1.11.G HIP.3/4.STO.1.M16.G</p>	1-1102600-5 0-1106408-1		
	M16 M20	11	<p>HIP-K HIP-K.3/4.STO.1.11.G HIP-K.3/4.STO.1.M16.G HIP-K.3/4.STO.1.M20.G</p>	2-1102600-5 0-1106408-2 0-1106408-3		
	M16 M20	11	<p>EMV-K EMV-K.3/4.STO.1.11.G EMV-K.3/4.STO.1.M16.G EMV-K.3/4.STO.1.M20.G</p>	4-1102700-5 0-1106402-2 0-1106402-3		
	<p>Anbaugeschäuse: Kabeleingang unten <i>Surface mounted housing: Bottom entry</i></p>   <p>Montageausschnitt/Panel cut-out 21 x 21</p>			<p>HIP HIP.3/4.AG</p>	1-1102603-5	
				<p>HIP-K HIP-K.3/4.AG</p>	2-1102603-5	
				<p>EMV-K EMV-K.3/4.AG</p>	4-1102703-5	
		<p>Sockelgehäuse: Kabeleingang unten (durch Montageausschnitt) <i>Surface mounted housing: Bottom entry (by panel cut-out)</i></p>   <p>Montageausschnitt/Panel cut-out ø 20</p>			<p>HIP HIP.3/4.SGF</p>	1-1102602-5
					<p>HIP-K HIP-K.3/4.SGF</p>	2-1102602-5
					<p>EMV-K EMV-K.3/4.SGF</p>	4-1102702-5

Passende Kabelverschraubungen ab Seite 188/Suitable Cable fittings from page 188

HIP.3/4, HIP-K.3/4, EMV-K.3/4 Gehäuse/Housings

Baugröße/Size 1

HIP: Druckdicht, silbergrau, **HIP-K:** Korrosionsgeschützt, schwarz

EMV-K: Schutz gegen elektromagnetische Beeinflussung, druckdicht, korrosionsgeschützt, schwarz

HIP: Pressure-tight, silver-grey, **HIP-K:** Housings corrosion-resistant, black

EMV-K: Protection against electro-magnetic interference, pressure-tight, housings corrosion-resistant, black

Schraubverriegelung am Oberteil/Screw lock on hood

IP 68

Bezeichnung Description	Metr.	PG	Bestelltext Designation	Bestell-Nr. Order No.
Sockelgehäuse: Kabeleingang seitlich Surface mounted housing: Side entry				
	M16 M20	11	HIP HIP.3/4.SG.1.11.G HIP.3/4.SG.1.M16.G HIP.3/4.SG.1.M20.G	1-1102601-5 0-1106407-1 0-1106401-4
	M16	11	HIP-K HIP-K.3/4.SG.1.11.G HIP-K.3/4.SG.1.M16.G	2-1102601-5 0-1106407-2
	M16 M20	11	EMV-K EMV-K.3/4.SG.1.11.G EMV-K.3/4.SG.1.M16.G EMV-K.3/4.SG.1.M20.G	4-1102701-5 0-1106401-2 0-1106401-3
Schutzkappe für Gehäuse-Unterteile Protective covers for housings				
			HIP/EMV HIP/EMV.3/4.SKB	3-1106200-5
			HIP-K/EMV-K HIP-K/EMV-K.3/4.SKB	4-1106200-5

Passende Kabelverschraubungen ab Seite 188/Suitable Cable fittings from page 188

HG-Q Kontakteinsätze/Contact inserts **Baugröße/Size Q**

**Kontaktzahlen
No. of contacts**

4/2 + ⊕



8 + ⊕

10

4 x 690 V/40A & 2 x 250 V/10A

8 x 500 V/16A

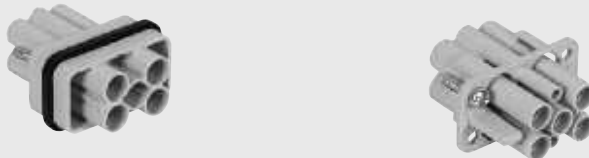
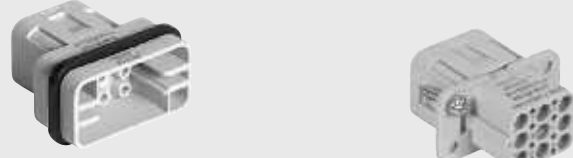
10 x 400 V/20A

Bezeichnung Description	Bestelltext Designation	Bestell-Nr./Order No.	
		Stifteinsatz Male insert	Buchseinsatz Female insert
<p>Stifteinsatz/Male insert</p> <p>Buchseinsatz/Female insert</p> <p>Crimpanschluss/Crimp terminal</p>  <p>Passende Crimpkontakte Power siehe Seite 39, passende Crimpkontakte Signal siehe Seite 34 Suitable Crimp contacts power see page 39, suitable Crimp contacts signal see page 39</p> <p>Crimpanschluss/Crimp terminal</p>  <p>Passende Crimpkontakte siehe Seite 37/Suitable Crimp contacts see page 37</p> <p>Crimpanschluss/Crimp terminal</p>  <p>Passende Crimpkontakte siehe Seite 36/Suitable Crimp contacts see page 36</p>	<p>HG-Q.4/2.Sti.C</p> <p>HG-Q.4/2.Bu.C</p> <p>HG-Q.8.Sti.C</p> <p>HG-Q.8.Bu.C</p> <p>HG-Q.10 Housings</p> <p>HG-Q.10.Sti.C</p> <p>HG-Q.10.Bu.C</p>	<p>0-1103095-1</p> <p>0-1103096-1</p> <p>0-1103070-1</p> <p>0-1103071-1</p> <p>X-1103092-X</p> <p>0-1108808-1</p> <p>0-1103091-1</p>	<p>0-1103096-1</p> <p>0-1103071-1</p> <p>0-1103091-1</p>

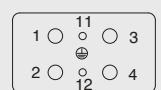
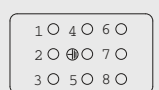
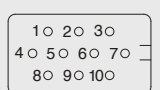
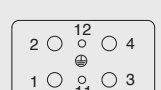
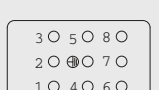
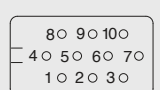
HE-Q.4/2	HE-Q.8	HE-Q.10
<p>Kontaktanordnung Anschlußseite Stift/Contact arrangement Male insert</p> 		
<p>Kontaktanordnung Anschlußseite Buchse/Contact arrangement Female insert</p> 		

HG-Q Gehäuse/Housings

Baugröße/Size Q

Kunststoff, glasfaserverstärkt

EMV: Schutz gegen elektromagnetische Beeinflussung

Plastic glass-fibre reinforced

EMV: Protection against electro-magnetic interference

IP 65

Bezeichnung Description	Metr.	PG	Bestelltext Designation	Bestell-Nr. Order No.
Steckergehäuse: Kabeleingang oben Hood: Top entry	M25		HG-Q.STO.1.M25.Z	0-1103073-2
	M25		EMV HG-Q-EMV.STO.1.M25.Z	0-1103073-4
	M25		HG-Q.STS.1.M25.Z	0-1103073-1
Steckergehäuse: Kabeleingang seitlich Hood: Side entry	M25		EMV HG-Q-EMV.STO.1.M25.Z	0-1103073-3
	M25		HG-Q.STS.2.M25.Z	0-1103155-1
	M25		EMV HG-Q-EMV.STS.2.M25.Z	0-1103155-2
Steckergehäuse: Kabeleingang zweiseitig Hood: both side entry	M25		HG-Q.STS.2.M25.Z	0-1103155-1
	M25		EMV HG-Q-EMV.STS.2.M25.Z	0-1103155-2

Passende Kabelverschraubungen Seite 59/Suitable Cable fittings page 59

HG-Q Gehäuse/Housings

Baugröße/Size Q

Kunststoff, glasfaserverstärkt

EMV: Schutz gegen elektromagnetische Beeinflussung

Plastic glass-fibre reinforced

EMV: Protection against electro-magnetic interference

IP 65

Bezeichnung Description	Metr.	PG	Bestelltext Designation	Bestell-Nr. Order No.
Kupplungsgehäuse: Kabeleingang unten <i>Cable-to-cable hood: Bottom entry</i>	M25		HG-Q.KDO-LB.1.M25.Z	0-1108795-1
	M25		EMV HG-Q-EMV.KDO-LB.1.M25.Z	0-1108795-3
	M25		HG-Q.KDS-LB.1.M25.Z	0-1108795-2
Kupplungsgehäuse: Kabeleingang seitlich <i>Cable-to-cable hood: Side entry</i>	M25		EMV HG-Q-EMV.KDS-LB.1.M25.Z	0-1108795-4
	M25		HG-Q.AG-LB	0-1103072-1
	M25		EMV HG-Q-EMV.AG-LB	0-1103072-2
Kupplungsgehäuse: Kabeleingang unten <i>Surface mount housing: Bottom entry</i>	M25		HG-Q.AG-LB	0-1103072-1
	M25		EMV HG-Q-EMV.AG-LB	0-1103072-2
	M25		HG-Q.AG-LB	0-1103072-1

Passende Kabelverschraubungen Seite 59/Suitable Cable fittings page 59

HG-Q.10 Motorgehäuse/Motor housings

Baugröße/Size Q

Kunststoff, glasfaserverstärkt

EMV: Schutz gegen elektromagnetische Beeinflussung

Plastic glass-fibre reinforced

EMV: Protection against electro-magnetic interference

400 V/20 A

IP 65

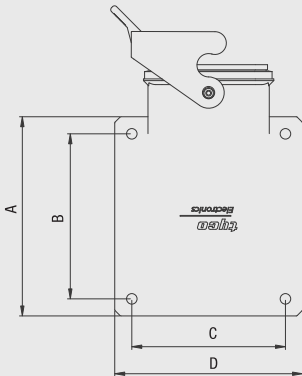
Bezeichnung Description	Metr.	PG	Bestelltext Designation	Bestell-Nr. Order No.																																								
 <div data-bbox="496 1285 799 1659" style="text-align: center;">  </div> <div data-bbox="491 1765 671 1792" style="text-align: center;"> <p>Maße/Dimensions mm</p> </div> <table border="1" data-bbox="491 1805 874 2056"> <thead> <tr> <th>PN</th> <th>A</th> <th>B</th> <th>C</th> <th>D</th> </tr> </thead> <tbody> <tr> <td>0-1, 0-8</td> <td>70</td> <td>58</td> <td>54</td> <td>66</td> </tr> <tr> <td>0-2, 0-9</td> <td>70</td> <td>60</td> <td>60</td> <td>70</td> </tr> <tr> <td>0-3, 1-0</td> <td>74</td> <td>56</td> <td>56</td> <td>74</td> </tr> <tr> <td>0-4, 1-1</td> <td>75</td> <td>64</td> <td>64</td> <td>75</td> </tr> <tr> <td>0-5, 1-2</td> <td>120</td> <td>105</td> <td>105</td> <td>120</td> </tr> <tr> <td>0-6, 1-3</td> <td>140</td> <td>125</td> <td>125</td> <td>140</td> </tr> <tr> <td>0-7, 1-4</td> <td>165</td> <td>130</td> <td>150</td> <td>165</td> </tr> </tbody> </table>	PN	A	B	C	D	0-1, 0-8	70	58	54	66	0-2, 0-9	70	60	60	70	0-3, 1-0	74	56	56	74	0-4, 1-1	75	64	64	75	0-5, 1-2	120	105	105	120	0-6, 1-3	140	125	125	140	0-7, 1-4	165	130	150	165			HG-Q.10.MC.1 EMV HG-Q.10-EMV.MC.1	0-1103092-1 0-1103092-8
	PN	A	B	C	D																																							
	0-1, 0-8	70	58	54	66																																							
	0-2, 0-9	70	60	60	70																																							
	0-3, 1-0	74	56	56	74																																							
	0-4, 1-1	75	64	64	75																																							
	0-5, 1-2	120	105	105	120																																							
	0-6, 1-3	140	125	125	140																																							
	0-7, 1-4	165	130	150	165																																							
				HG-Q.10.MC.2 EMV HG-Q.10-EMV.MC.2	0-1103092-2 0-1103092-9																																							
				HG-Q.10.MC.3 EMV HG-Q.10-EMV.MC.3	0-1103092-3 1-1103092-0																																							
				HG-Q.10.MC.4 EMV HG-Q.10-EMV.MC.4	0-1103092-4 1-1103092-1																																							
				HG-Q.10.MC.5 EMV HG-Q.10-EMV.MC.5	0-1103092-5 1-1103092-2																																							
				HG-Q.10.MC.6 EMV HG-Q.10-EMV.MC.6	0-1103092-6 1-1103092-3																																							
			HG-Q.10.MC.7 EMV HG-Q.10-EMV.MC.7	0-1103092-7 1-1103092-4																																								

Passende Crimpkontakte Seite 36/Suitable Crimp contacts page 36

HG-Q Zubehör/Accessories

Baugröße/Size Q



Kunststoff, glasfaserverstärkt

EMV: Schutz gegen elektromagnetische Beeinflussung

Plastic glass-fibre reinforced

EMV: Protection against electro-magnetic interference

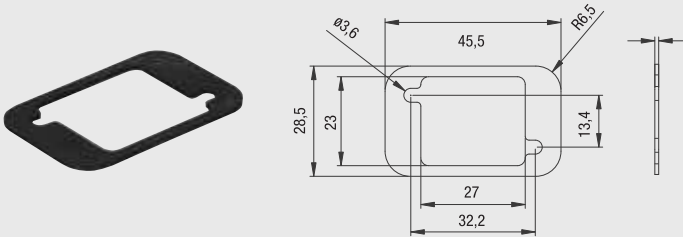
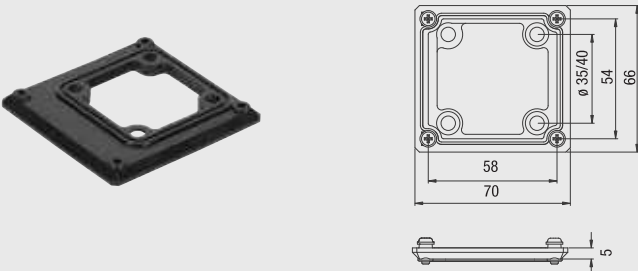
IP 65

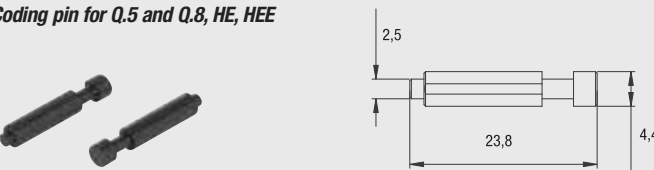
Bezeichnung Description	Metr.	PG	Bestelltext Designation	Bestell-Nr. Order No.
<p>Flanschdichtung für HG-Q.8 Anbaugehäuse Flange sealing for HG-Q.8 Surface Mount Housing</p> 			<p>Leitend / Conductive HG-Q.FI-dicht-L</p>	<p>0-1108794-2</p>
<p>Adapterplatte für HG-Q.10, IP 65 aus Kunststoff Adaptor flange for HG-Q.10, IP 65 plastic</p> 			<p>HG-Q.10.FL.1 HG-Q.10.FL.2</p>	<p>0-1103093-1 0-1103093-2</p>
<p>Hut-Verschraubung M, IP 68 aus Kunststoff Gland fitting, IP 68 plastic</p>  <p data-bbox="751 1417 871 1574"> Gelb/Yellow Grau/Grey Schwarz/Black Grün/Green Rot/Red Weiß/White </p> <p data-bbox="134 1581 480 1659"> Alle Hut-Verschraubungen werden mit schwarzen M25 Druckschrauben geliefert All glands are supplied with a black M25 nut </p>	<p>M25 M25 M25 M25 M25 M25</p>		<p>HG-Q.M25.6,5/4,0 HG-Q.M25.8,0/5,0 HG-Q.M25.9,5/6,5 HG-Q.M25.10,5/7,0 HG-Q.M25.13,0/9,0 HG-Q.M25.15,5/11,5</p>	<p>0-1103074-1 0-1103074-2 0-1103074-3 0-1103074-4 0-1103074-5 0-1103074-6</p>
<p>Abdeckung für alle HG-Q Gehäuse/Cover for all HG-Q housings</p> 			<p>Set-HG-Q.8.SKP</p>	<p>0-1108818-1</p>
<p>Sicherheitsstift für Q.5 und Q.8, HE, HEE Coding pin for Q.5 and Q.8, HE, HEE</p> 			<p>Sich-Stift.HVE.C</p>	<p>0-1110984-4</p>

HA.10 Kontakteinsätze/Contact inserts

Baugröße/Size 2

Schraubanschluss, Federzug-Anschluss,
Crimpschluss für gedrehte HE/HA Crimpkontakte

Kontaktzahlen
No. of contacts

*Screw terminal, Spring Clamp terminal,
Crimp terminal for screw machined HE/HA crimp contacts*

10 +

250 V/16A

Bezeichnung Description	Bestelltext Designation	Bestell-Nr./Order No.	
		Stifteinsatz Male insert	Buchseinsatz Female insert
<p>Stifteinsatz/Male insert</p> <p>Schraubanschluss/Screw terminal</p>	HA.10.Sti.S.B1-10	1-1103414-1	
<p>Buchseinsatz/Female insert</p>	HA.10.Bu.S.B1-10		1-1103415-1
<p>Federzug-Anschluss/Spring Clamp terminal</p>	HA.10.Sti.SC.B1-10	7-1103414-1	
<p>Buchseinsatz/Female insert</p>	HA.10.Bu.SC.B1-10		7-1103415-1
<p>Crimpschluss/Crimp terminal</p>	HA.10.Sti.C.B1-10	2-1103414-3	
<p>Buchseinsatz/Female insert</p>	HA.10.Bu.C.B1-10		2-1103415-3

Maße/Dimensions	A	B	C	D	E
mm	49,5	57	23	31	28

Passende Crimpkontakte siehe Seite 37, Passende Crimpwerkzeuge siehe Seite 37
Suitable Crimp contacts see page 37, Suitable Crimping tools see page 37

Maßbild mm
Dimensions mm

*Abstand für sichere Kontaktgabe max. 24 mm

Kontaktanordnung Anschlußseite Stift
Contact arrangement Male insert

Kontaktanordnung Anschlußseite Buchse
Contact arrangement Female insert

Montageausschnitt
Panel cut-out

HN.D.15 Kontakteinsätze/Contact inserts

Baugröße/Size 2

Crimpanschluss für gedrehte HN.D Crimpkontakte

**Kontaktzahlen
No. of contacts**

Crimp terminal for screw machined HN.D crimp contacts

15 +

250 V/10 A

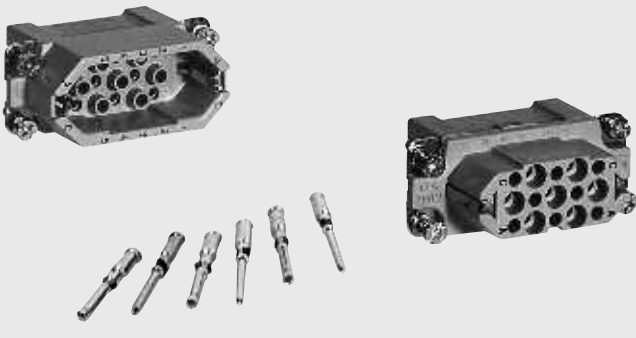
Bezeichnung Description	Bestelltext Designation	Bestell-Nr./Order No.	
		Stifteinsatz Male insert	Buchseinsatz Female insert
<p>Stifteinsatz/Male insert</p> <p>Crimpanschluss/Crimp terminal</p> 	HN.D.15.Sti.C	2-1103106-3	
<p>Buchseinsatz/Female insert</p>	HN.D.15.Bu.C		2-1103107-3

Maße/Dimensions	A	B	C	D	E
mm	49,5	57	23	35	35

Passende Crimpkontakte siehe Seite 34, Passende Crimpwerkzeuge siehe Seite 34
 Suitable Crimp contacts see page 34, Suitable Crimping tools see page 34

**Maßbild mm
Dimensions mm**

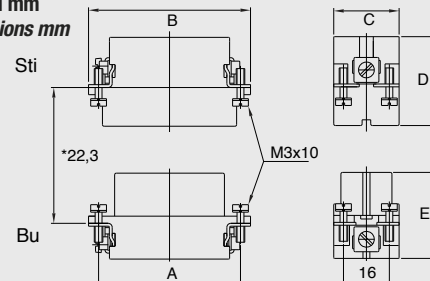

*Abstand für sichere Kontaktgabe max. 24 mm

Kontaktanordnung Anschlußseite Stift
Contact arrangement Male insert

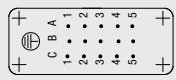

Kontaktanordnung Anschlußseite Buchse
Contact arrangement Female insert

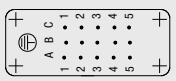

Montageausschnitt
Panel cut-out

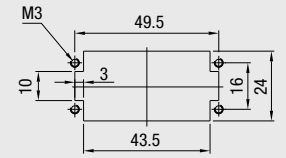

HD.15 Kontakteinsätze/Contact inserts **Baugröße/Size 2**

Crimpanschluss für gestanzte HD.M Crimpkontakte

Kontaktzahlen
No. of contacts

Crimp terminal for stamped HD .Mcrimp contacts

15 +

250 V/10 A

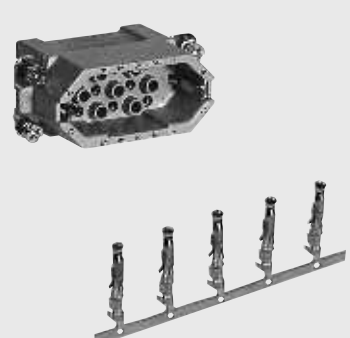
Bezeichnung Description	Bestelltext Designation	Bestell-Nr./Order No.													
		Stifteinsatz Male insert	Buchseinsatz Female insert												
<p>Stifteinsatz/Male insert</p> <p>Crimpanschluss/Crimp terminal</p> 	<p>HD.15.Sti.C</p> <p>HD.15.Bu.C</p>	<p>2-1103004-3</p>	<p>2-1103005-3</p>												
<table border="1"> <tr> <th>Maße/Dimensions</th> <th>A</th> <th>B</th> <th>C</th> <th>D</th> <th>E</th> </tr> <tr> <td>mm</td> <td>49,5</td> <td>57</td> <td>23</td> <td>35</td> <td>35</td> </tr> </table>	Maße/Dimensions	A	B	C	D	E	mm	49,5	57	23	35	35			
Maße/Dimensions	A	B	C	D	E										
mm	49,5	57	23	35	35										

Passende Crimpkontakte siehe Seite 35, Passende Crimpwerkzeuge siehe Seite 35
 Suitable Crimp contacts see page 35, Suitable Crimping tools see page 35

Maßbild mm
Dimensions mm

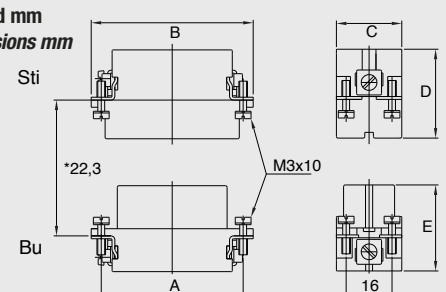

*Abstand für sichere Kontaktgabe max. 24 mm

Kontaktanordnung Anschlußseite Stift
Contact arrangement Male insert

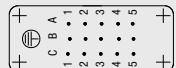

Kontaktanordnung Anschlußseite Buchse
Contact arrangement Female insert

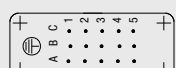

Montageausschnitt
Panel cut-out

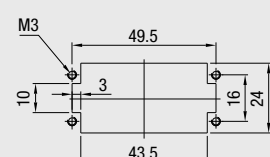

HA.10/HD.15 Gehäuse/Housings

Baugröße/Size 2

Pulverbeschichtet, silbergrau

Powder-coated, silver-grey

Längsbügel am Unterteil/Side clip at housing bottom

IP 65

Bezeichnung Description	Metr.	PG	Bestelltext Designation	Bestell-Nr. Order No.
<p>Steckergehäuse: Kabeleingang seitlich, Standard Bauform <i>Hood: Side entry, Standard construction</i></p>	M20 M25	13 16	HA.10.STS.1.13.G HA.10.STS.1.16.G HA.10.STS.1.M.20.G HA.10.STS.1.M.25.G	0-1102599-3 1-1102117-7 0-1106411-2 0-1106411-6
<p>Steckergehäuse: Kabeleingang seitlich, Hohe Bauform <i>Hood: Side entry, High construction</i></p>	M25	16 21	HD.15.STS.1.16.G HD.15.STS.1.21.G HD.15.STS.1.M.25.G	1-1102427-7 1-1102430-7 0-1106414-2
<p>Steckergehäuse: Kabeleingang oben, Standard Bauform <i>Hood: Top entry, Standard construction</i></p>	M20	16	HA.10.STO.1.16.G HA.10.STO.1.M.20.G	1-1102120-7 0-1106411-1
<p>Steckergehäuse: Kabeleingang oben, Hohe Bauform <i>Hood: Top entry, High construction</i></p>	M25	16 21	HD.15.STO.1.16.G HD.15.STO.1.21.G HD.15.STO.1.M.25.G	1-1102433-7 1-1102436-7 0-1106414-1

Passende Kabelverschraubungen ab Seite 188/Suitable Cable fittings from page 188

HA.10/HD.15 Gehäuse/Housings

Baugröße/Size 2

Pulverbeschichtet, silbergrau

Powder-coated, silver-grey

Längsbügel am Unterteil/Side clip at housing bottom

IP 65

Bezeichnung Description	Metr.	PG	Bestelltext Designation	Bestell-Nr. Order No.
<p>Anbaugehäuse: Kabeleingang unten, Standard Bauform <i>Surface mounted housing: Bottom entry, Standard construction</i></p>			HA.10.AG-LB	1-1102121-2
<p>Anbaugehäuse: Kabeleingang unten, Standard Bauform <i>Surface mounted housing: Bottom entry, Standard construction</i></p> <p>Montageausschnitt/ Panel cut-out</p>			HA.10.AGD-LB	1-1102122-2
<p>Sockelgehäuse: Kabeleingang seitlich, Standard Bauform <i>Surface mounted housing: Side entry, Standard construction</i></p>	M20 2xM20	16 2x16	HA.10.SG-LB.1.16.Z HA.10.SG-LB.2.16.Z HA.10.SG-LB.1.M20.Z HA.10.SG-LB.2.M20.Z	1-1102124-2 1-1102126-2 0-1103057-1 0-1106410-2
<p>Sockelgehäuse: Kabeleingang seitlich, Hohe Bauform <i>Surface mounted housing: Side entry, High construction</i></p>	2xM25	16 21 2x16 2x21	HD.15.SG-LB.1.16.Z HD.15.SG-LB.1.21.Z HD.15.SG-LB.2.16.Z HD.15.SG-LB.2.21.Z HD.15.SG-LB.2.M25.Z	1-1102438-2 1-1102442-2 1-1102440-2 1-1102444-2 0-1106413-2

Passende Kabelverschraubungen ab Seite 188/Suitable Cable fittings from page 188

HA.10/HD.15 Gehäuse/Housings

Baugröße/Size 2

Pulverbeschichtet, silbergrau

Powder-coated, silver-grey

Längsbügel am Unterteil/Side clip at housing bottom

IP 65

Bezeichnung Description	Metr.	PG	Bestelltext Designation	Bestell-Nr. Order No.
<p>Sockelgehäuse: Kabeleingang seitlich, Standard Bauform <i>Surface mounted housing: Side entry, Standard construction</i></p>	M20 2xM20	16 2x16	HA.10.SGD-LB.1.16.Z HA.10.SGD-LB.2.16.Z HA.10.SGD-LB.1.M20.Z HA.10.SGD-LB.2.M20.Z	1-1102128-2 1-1102130-2 0-1103057-2 0-1106410-1
<p>Sockelgehäuse: Kabeleingang seitlich, Hohe Bauform <i>Surface mounted housing: Side entry, High construction</i></p>	2xM25	16 21 2x16 2x21	HD.15.SGD-LB.1.16.Z HD.15.SGD-LB.1.21.Z HD.15.SGD-LB.2.16.Z HD.15.SGD-LB.2.21.Z HD.15.SGD-LB.2.M25.Z	1-1102446-2 1-1102450-2 1-1102448-2 1-1102452-2 0-1106413-1
<p>Kupplungsgehäuse: Kabeleingang unten, Standard Bauform <i>Cable-to-cable hood: Bottom entry, Standard construction</i></p>	M20	16	HA.10.KDO-LB.1.16.G HA.10.KDO-LB.1.M20.G	1-1102133-2 0-1106409-1
<p>Kupplungsgehäuse: Kabeleingang unten, Hohe Bauform <i>Cable-to-cable hood: Bottom entry, High construction</i></p>	M25	16 21	HD.15.KDO-LB.1.16.G HD.15.KDO-LB.1.21.G HD.15.KDO-LB.1.M25.G	1-1102455-2 1-1102458-2 0-1106412-1

Passende Kabelverschraubungen ab Seite 188/Suitable Cable fittings from page 188

Verbindlich für Toleranzen der Abmessungen und technische Werte sind ausschließlich die neuesten TE Connectivity Kundenzeichnungen bzw. Produkt-Spezifikationen, die Sie auf Anfrage erhalten.
All specifications subject to change. Consult TE Connectivity for latest design specifications.

HE.6 Kontakteinsätze/Contact inserts

Baugröße/Size 3

Schraubanschluss, Federzug-Anschluss,
Crimpschluss für gedrehte HE/HA Crimpkontakte

**Kontaktzahlen
No. of contacts**

*Screw terminal, Spring Clamp terminal,
Crimp terminal for screw machined HE/HA crimp contacts*

6 +

400 V/16 A

Bezeichnung Description	Bestelltext Designation	Bestell-Nr./Order No.	
		Stifteinsatz Male insert	Buchseinsatz Female insert
<p>Stifteinsatz/Male insert</p> <p>Schraubanschluss/Screw terminal</p>	HE.6.Sti.S	1-1103634-1	
<p>Buchseinsatz/Female insert</p>	HE.6.Bu.S		1-1103635-1
<p>Federzug-Anschluss/Spring Clamp terminal</p>	HE.6.Sti.SC	7-1103634-1	
	HE.6.Bu.SC		7-1103635-1
<p>Crimpschluss/Crimp terminal</p>	HE.6.Sti.C	2-1103634-3	
	HE.6.Bu.C		2-1103635-3

Maße/Dimensions	A	B	C	D	E
mm	44	52	33	34	35

Passende Crimpkontakte siehe Seite 37, Passende Crimpwerkzeuge siehe Seite 37
 Suitable Crimp contacts see page 37, Suitable Crimping tools see page 37

**Maßbild mm
Dimensions mm**

*Abstand für sichere Kontaktgabe max. 21 mm

**Kontaktanordnung Anschlußseite Stift
Contact arrangement Male insert**

**Kontaktanordnung Anschlußseite Buchse
Contact arrangement Female insert**

**Montageausschnitt
Panel cut-out**

HEE.10 Kontakteinsätze/Contact inserts **Baugröße/Size 3**



Crimpanschluss für gedrehte HE Crimpkontakte

**Kontaktzahlen
No. of contacts**

Crimp terminal for screw machined HE crimp contacts

10 +

500 V/16 A

Bezeichnung Description		Bestelltext Designation	Bestell-Nr./Order No.	
Stifteinsatz/Male insert	Buchseinsatz/Female insert		Stifteinsatz Male insert	Buchseinsatz Female insert
<p>Crimpanschluss/Crimp terminal</p> 		<p>HEE.10.Sti.C HEE.10.Sti.C.FS*</p>	<p>0-1102918-1 0-1102918-2</p>	
		<p>HEE.10.Bu.C HEE.10.Bu.C.FS*</p>		<p>0-1102919-1 0-1102919-2</p>

*Kunststoff ist I2F1 qualifiziert nach NF-F 16-101, 102
Plastic is qualified I2F1 according NF-F 16-101, 102

Maße/Dimensions	A	B	C	D	E
mm	44	51	33	34	37

Passende Crimpkontakte siehe Seite 37, Passende Crimpwerkzeuge siehe Seite 37
Suitable Crimp contacts see page 37, Suitable Crimping tools see page 37

**Maßbild mm
Dimensions mm**

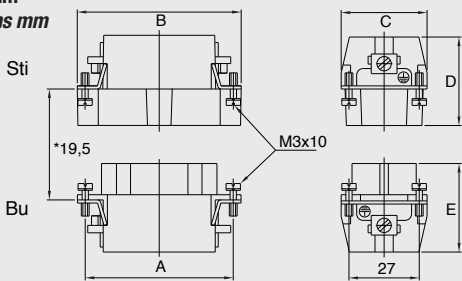

*Abstand für sichere Kontaktgabe max. 21 mm

**Kontaktanordnung Anschlußseite Stift
Contact arrangement Male insert**

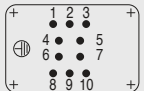

**Kontaktanordnung Anschlußseite Buchse
Contact arrangement Female insert**

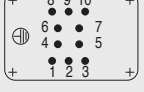

**Montageausschnitt
Panel cut-out**

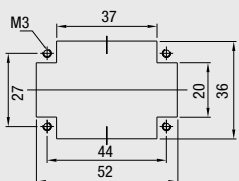

HVT.8 Kontakteinsätze/Contact inserts **Baugröße/Size 3**



Crimpanschluss für gedrehte HVT Crimpkontakte

Kontaktzahlen
No. of contacts

Crimp terminal for screw machined HVT crimp contacts

8 +

400 V/16 A

Bezeichnung Description		Bestelltext Designation	Bestell-Nr./Order No.	
			Stifteinsatz Male insert	Buchseinsatz Female insert
Stifteinsatz/Male insert	Buchseinsatz/Female insert			
Crimpanschluss/Crimp terminal				
		HVT.8.Sti.C	2-1104000-3	
		HVT.8.Bu.C		2-1104002-3

Maße/Dimensions	A	B	C	D	E
mm	44	51	33	35	40

Passende Crimpkontakte siehe Seite 38, Passende Crimpwerkzeuge siehe Seite 38
 Suitable Crimp contacts see page 38, Suitable Crimping tools see page 38

Maßbild mm
Dimensions mm

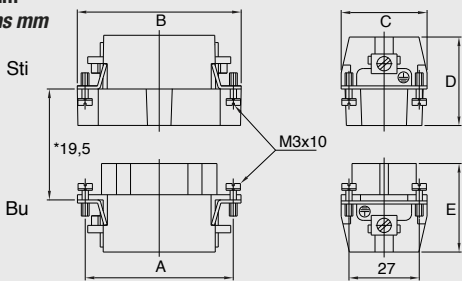

*Abstand für sichere Kontaktgabe max. 21 mm

Kontaktanordnung Anschlußseite Stift
Contact arrangement Male insert

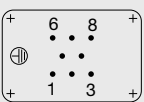

Kontaktanordnung Anschlußseite Buchse
Contact arrangement Female insert

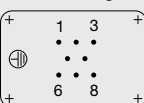

Montageausschnitt
Panel cut-out

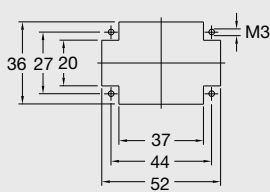

HD.16 Kontakteinsätze/Contact inserts

Baugröße/Size 3

Crimpanschluss für gestanzte HD.M Crimpkontakte

**Kontaktzahlen
No. of contacts**

Crimp terminal for stamped HD.M crimp contacts

16 +

250 V/10 A

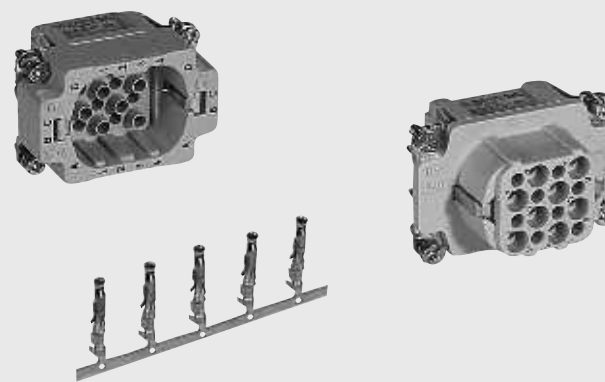
Bezeichnung Description	Bestelltext Designation	Bestell-Nr./Order No.	
		Stifteinsatz Male insert	Buchseinsatz Female insert
<p>Stifteinsatz/Male insert</p> <p>Crimpanschluss/Crimp terminal</p> 	HD.16.Sti.C	2-1103006-3	
<p>Buchseinsatz/Female insert</p>	HD.16.Bu.C		2-1103007-3

Maße/Dimensions	A	B	C	D	E
mm	44	51	33	35	35

Passende Crimpkontakte siehe Seite 35, Passende Crimpwerkzeuge siehe Seite 35
 Suitable Crimp contacts see page 35, Suitable Crimping tools see page 35

Maßbild mm
Dimensions mm

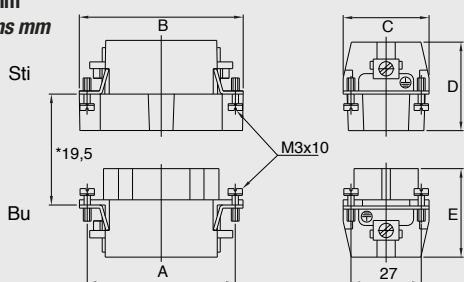

*Abstand für sichere Kontaktgabe max. 21 mm

Kontaktanordnung Anschlußseite Stift
Contact arrangement Male insert

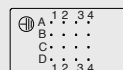

Kontaktanordnung Anschlußseite Buchse
Contact arrangement Female insert

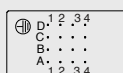

Montageausschnitt
Panel cut-out

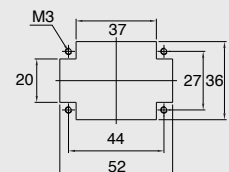

HN.2D.24 Kontakteinsätze/Contact inserts

Baugröße/Size 3



Crimpanschluss für gedrehte HN.D Crimpkontakte

**Kontaktzahlen
No. of contacts**

Crimp terminal for screw machined HN.D crimp contacts

24 +

250 V/10 A

Bezeichnung Description	Bestelltext Designation	Bestell-Nr./Order No.	
		Stifteinsatz Male insert	Buchseinsatz Female insert
<p>Stifteinsatz/Male insert</p> <p>Crimpanschluss/Crimp terminal</p> 	HN.2D.24.Sti.C	2-1103200-3	
<p>Buchseinsatz/Female insert</p> 	HN.2D.24.Bu.C		2-1103202-3

Maße/Dimensions	A	B	C	D	E
mm	44	55	34	36,5	37

Passende Crimpkontakte siehe Seite 34, Passende Crimpwerkzeuge siehe Seite 34
 Suitable Crimp contacts see page 34, Suitable Crimping tools see page 34

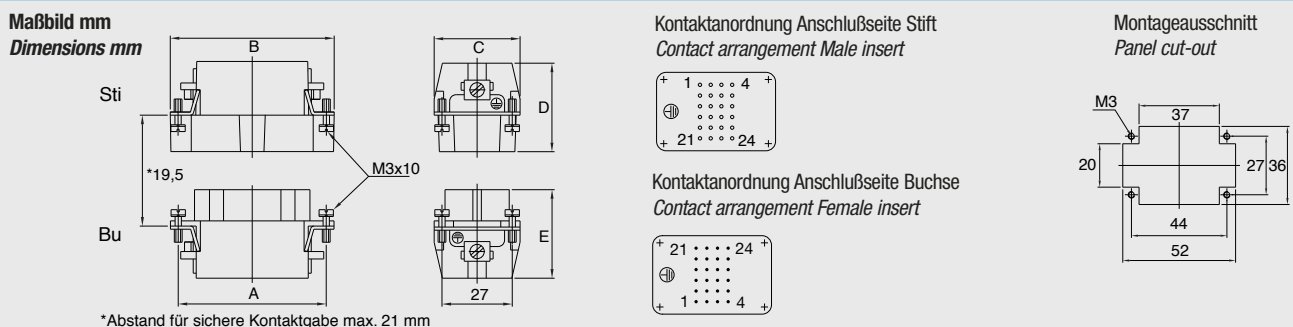

HSK 4+2 Kontakteinsätze/Contact inserts **Baugröße/Size 3**



Schraubanschluss

**Kontaktzahlen
No. of contacts**

Screw terminal

4 + 2 +

500V/40A + 400 V/16 A

Bezeichnung Description		Bestelltext Designation	Bestell-Nr./Order No.		
			Stifteinsatz Male insert	Buchseinsatz Female insert	
Stifteinsatz/Male insert	Buchseinsatz/Female insert				
Schraubanschluss/Screw termination					
		HSK.4+2.Bu.S			0-1103084-1
		HSK.4+2.Sti.S	0-1103085-1		

Maße/Dimensions	A	B	C	D	E
mm	44	55	34	36,5	37

**Maßbild mm
Dimensions mm**

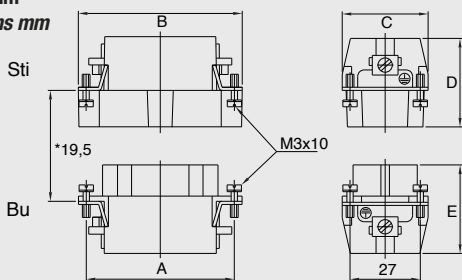

**Kontaktanordnung Anschlußseite Stift
Contact arrangement Male insert**

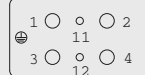

**Kontaktanordnung Anschlußseite Buchse
Contact arrangement Female insert**

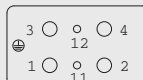

**Montageausschnitt
Panel cut-out**

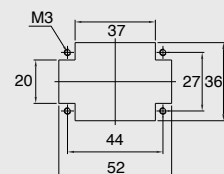

Modul Halterahmen/Module Fixing Frame

Baugröße/Size 3

Bezeichnung
Description

Bestelltext
Designation

Bestell-Nr./Order No.
Oberteil
Top part

Unterteil
Bottom part

Halterahmen/*Fixing frame*

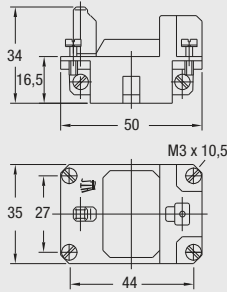

MDL2-GR.0/U-3

0-1108784-1

0-1108784-1

Für Modul MDL Seite 194–203
For module MDL page 194–203

Montageausschnitt/*Panel cut-out*

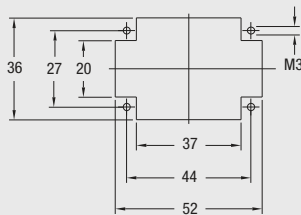

Halterahmen/*Fixing frame*

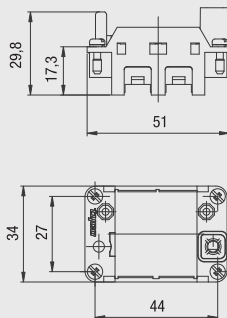

HVS-R.0 1-2
HVS-R.U 1-2

0-1103250-7

0-1103250-8

Für Modul HVS Seite 204–212
For module HVS page 204–212

Montageausschnitt/*Panel cut-out*

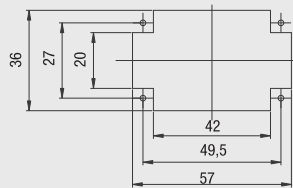

HB.6, HB-K.6, HD.16, HD-K.16 Gehäuse/Housings





Baugröße/Size 3

Pulverbeschichtet, silbergrau
 K = korrosionsgeschützt, schwarz

Powder-coated, silver-grey
K = corrosion-resistant, black

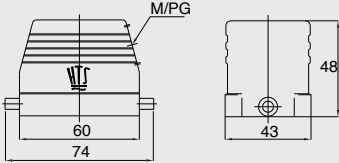
Längsbügel am Unterteil/Side clip at housing bottom

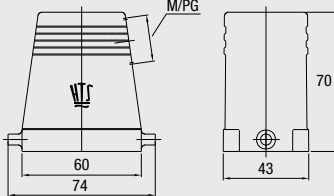
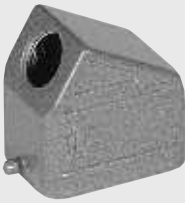
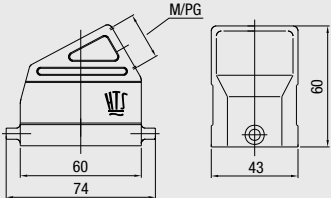
IP 65

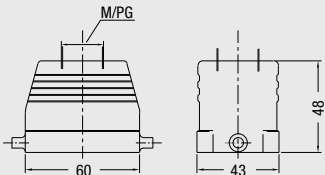
Bezeichnung Description	Metr.	PG	Bestelltext Designation	Bestell-Nr. Order No.
Steckergehäuse: Kabeleingang seitlich, Standard Bauform Hood: Side entry, Standard construction  	M16 M20 M25	16	HB.6.STS.1.16.G HB.6.STS.1.M16.G HB.6.STS.1.M20.G HB.6.STS.1.M25.G Mit Korrosionsschutz With corrosion protection	1-1102240-7 0-1106419-8 0-1106419-7 0-1106419-2
Steckergehäuse: Kabeleingang seitlich, Hohe Bauform Hood: Side entry, High construction  	M25 M32	21	HD.16.STS.1.21.G HD.16.STS.1.M25.G HD.16.STS.1.M32.G Mit Korrosionsschutz With corrosion protection	1-1102461-7 0-1102769-1 0-1106423-2
Steckergehäuse: Kabeleingang seitlich, Keilform Hood: Side entry, Standard construction  	M25	16	HB-KF.6.STS.1.16.G HB-KF.6.STS.1.M25.G Mit Korrosionsschutz With corrosion protection	1-1102205-7 0-1106420-1
Steckergehäuse: Kabeleingang oben, Standard Bauform Hood: Top entry, Standard construction  	M25	13 16	HB.6.STO.1.13.G HB.6.STO.1.16.G HB.6.STO.1.M25.G Mit Korrosionsschutz With corrosion protection	0-1102064-1 1-1102243-7 0-1106419-1
	M20 M25	16	HB-K.6.STO.1.16.G HB-K.6.STO.1.M20.G HB-K.6.STO.1.M25.G	2-1102243-7 0-1106423-9 0-1106419-3

Passende Kabelverschraubungen ab Seite 188/Suitable Cable fittings from page 188

HB.6, HB-K.6, HD.16, HD-K.16 Gehäuse/Housings







Baugröße/Size 3

Pulverbeschichtet, silbergrau/K = korrosionsgeschützt, schwarz

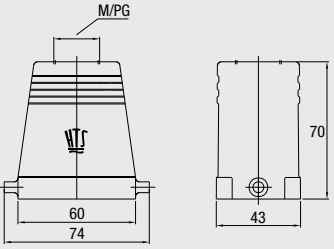
Powder-coated, silver-grey/K = corrosion-resistant, black

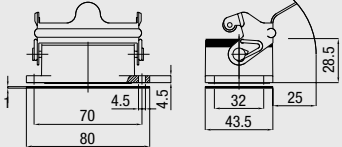
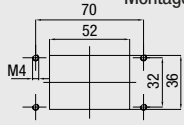
Längsbügel am Unterteil/Side clip at housing bottom

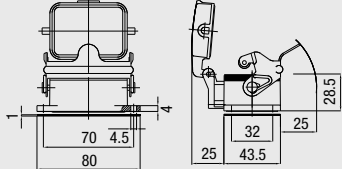
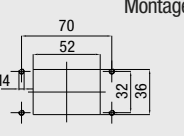
IP 65

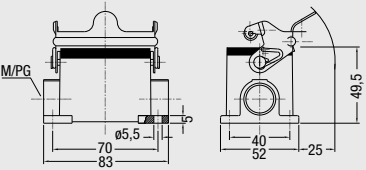
Bezeichnung Description	Metr.	PG	Bestelltext Designation	Bestell-Nr. Order No.
<p>Steckergehäuse: Kabeleingang oben, Hohe Bauform <i>Hood: Top entry, High construction</i></p>  	M25 M32	29 21	HD.16.STO.1.29.Z HD.16.STO.1.21.G HD.16.STO.1.M25.G HD.16.STO.1.M32.G Mit Korrosionsschutz <i>With corrosion protection</i>	1-1102469-7 1-1102467-7 1-1106423-1 0-1106423-1
<p>Anbaugehäuse: Kabeleingang unten, Standard Bauform <i>Surface mounted housing: Bottom entry, Standard construction</i></p>   <p>Montageausschnitt/Panel cut-out</p> 			HB.6.AG-LB Mit Korrosionsschutz <i>With corrosion protection</i>	1-1102244-2
<p>Anbaugehäuse: Kabeleingang unten, Standard Bauform <i>Surface mounted housing: Bottom entry, Standard construction</i></p>   <p>Montageausschnitt/Panel cut-out</p> 			HB.6.AGD-LB Mit Korrosionsschutz <i>With corrosion protection</i>	1-1102246-2
<p>Sockelgehäuse: Kabeleingang seitlich, Standard Bauform <i>Surface mounted housing: Side entry, Standard construction</i></p>  	M25 2xM25	16 2x16	HB.6.SG-LB.1.16.Z HB.6.SG-LB.2.16.Z HB.6.SG-LB.1.M25.Z HB.6.SG-LB.2.M25.Z Mit Korrosionsschutz <i>With corrosion protection</i>	1-1102249-2 1-1102251-2 0-1103062-1 0-1106418-2
		16 2x16	HB-K.6.SG-LB.1.16.Z HB-K.6.SG-LB.2.16.Z HB-K.6.SG-LB.2.M25.Z	2-1102249-2 2-1102251-2 0-1106418-4

Passende Kabelverschraubungen ab Seite 188/Suitable Cable fittings from page 188

HB.6, HB-K.6, HD.16, HD-K.16 Gehäuse/Housings

Baugröße/Size 3

Pulverbeschichtet, silbergrau/K = korrosionsgeschützt, schwarz

Powder-coated, silver-grey/K = corrosion-resistant, black

Längsbügel am Unterteil/Side clip at housing bottom

IP 65

Bezeichnung Description	Metr.	PG	Bestelltext Designation	Bestell-Nr. Order No.
Sockelgehäuse: Kabeleingang seitlich, Hohe Bauform <i>Surface mounted housing: Side entry, High construction</i> 	2xM32	21	HD.16.SG-LB.1.21.Z	1-1102472-2
		2x21	HD.16.SG-LB.2.21.Z HD.16.SG-LB.2.M32.Z	1-1102474-2 0-1106422-2
Sockelgehäuse: Kabeleingang seitlich, Standard Bauform <i>Surface mounted housing: Side entry, Standard construction</i> 	M16 M20 2xM25	16	HB.6.SGD-LB.1.16.Z	1-1102253-2
		2x16	HB.6.SGD-LB.2.16.Z HB.6.SGD-LB.1.M16.Z HB.6.SGD-LB.1.M20.Z HB.6.SGD-LB.2.M25.Z	1-1102255-2 0-1102849-1 0-1102849-2 0-1106418-1
Sockelgehäuse: Kabeleingang seitlich, Hohe Bauform <i>Surface mounted housing: Side entry, High construction</i> 	2xM32	16	HB-K.6.SGD-LB.1.16.Z	2-1102253-2
		2x16	HB-K.6.SGD-LB.2.16.Z HB-K.6.SGD-LB.2.M25.Z	2-1102255-2 0-1106418-3
Sockelgehäuse: Kabeleingang seitlich, Hohe Bauform <i>Surface mounted housing: Side entry, High construction</i> 	2xM32	21	HD.16.SGD-LB.1.21.Z	1-1102480-2
		2x21	HD.16.SGD-LB.2.21.Z HD.16.SGD-LB.2.M32.Z	1-1102482-2 0-1106422-1
Sockelgehäuse: Kabeleingang seitlich, Hohe Bauform <i>Surface mounted housing: Side entry, High construction</i> 	2xM32	21	HD-K.16.SGD-LB.1.21.Z	2-1102480-2
		2x21	HD-K.16.SGD-LB.2.21.Z HD-K.16.SGD-LB.2.M32.Z	2-1102482-2 0-1106422-3

Passende Kabelverschraubungen ab Seite 188/Suitable Cable fittings from page 188

HB.6, HB-K.6, HD.16, HD-K.16 Gehäuse/Housings



Baugröße/Size 3

Pulverbeschichtet, silbergrau/K = korrosionsgeschützt, schwarz

Powder-coated, silver-grey/K = corrosion-resistant, black

Längsbügel am Unterteil/Side clip at housing bottom

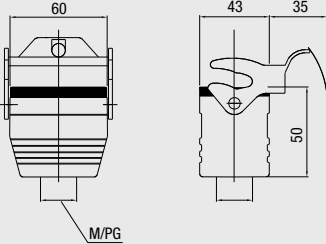
IP 65

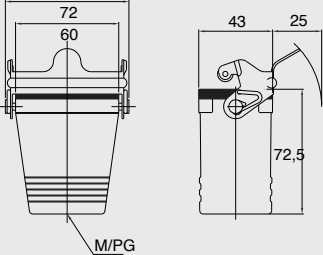
Bezeichnung Description	Metr.	PG	Bestelltext Designation	Bestell-Nr. Order No.
Kupplungsgehäuse: Kabeleingang unten, Standard Bauform <i>Cable-to-cable hood: Bottom entry, Standard construction</i>  	M25	16	HB.6.KDO-LB.1.16.G HB.6.KDO-LB.1.M25.G	1-1102258-2 0-1106417-1
	M25	16	Mit Korrosionsschutz <i>With corrosion protection</i> HB-K.6.KDO-LB.1.16.G HB-K.6.KDO-LB.1.M25.G	2-1102258-2 0-1106417-2
Kupplungsgehäuse: Kabeleingang unten, Hohe Bauform <i>Cable-to-cable hood: Bottom entry, High construction</i>  	M32	13 21	HB.6.KDO-LB.1.13.G HD.16.KDO-LB.1.21.G HD.16.KDO-LB.1.M32.G	0-1102258-1 1-1102489-2 0-1106421-1
	M32	21	Mit Korrosionsschutz <i>With corrosion protection</i> HD-K.16.KDO-LB.1.21.G HD-K.16.KDO-LB.1.M32.G	2-1102489-2 0-1106421-2

Passende Kabelverschraubungen ab Seite 188/Suitable Cable fittings from page 188

HB-Z.6, HB-K/Z.6, HD-Z.16, HD-K/Z.16 Gehäuse/Housings

Baugröße/Size 3

Pulverbeschichtet, silbergrau
 K = korrosionsgeschützt, schwarz

Powder-coated, silver-grey
K = corrosion-resistant, black

Zentralbügel am Steckergehäuse/Central locking clip on hood

IP 65

Bezeichnung Description	Metr.	PG	Bestelltext Designation	Bestell-Nr. Order No.
Steckergehäuse: Kabeleingang seitlich, Standard Bauform Hood: Side entry, Standard construction 	M25	16	HB-Z.6.STS-ZB.1.16.G HB-Z.6.STS-ZB.1.M25.G Mit Korrosionsschutz With corrosion protection	1-1102240-3 0-1106419-6
Steckergehäuse: Kabeleingang seitlich, Hohe Bauform Hood: Side entry, High construction 	M25	16	HB-K/Z.6.STS-ZB.1.16.G HB-K/Z.6.STS-ZB.1.M25.G	2-1102240-3 0-1106419-5
Steckergehäuse: Kabeleingang seitlich, Hohe Bauform Hood: Side entry, High construction 	M32	21	HD-Z.16.STS-ZB.1.21.G HD-Z.16.STS-ZB.1.M32.G Mit Korrosionsschutz With corrosion protection	1-1102461-3 0-1106423-5
Steckergehäuse: Kabeleingang seitlich, Keilform Hood: Side entry, Standard construction 	M25	21	HD-K/Z.16.STS-ZB.1.21.G	2-1102461-3
Steckergehäuse: Kabeleingang seitlich, Keilform Hood: Side entry, Standard construction 	M25	16	HB-KF-Z.6.STS-ZB.1.16.G HB-KF-Z.6.STS-ZB.1.M25.G Mit Korrosionsschutz With corrosion protection	1-1102205-3 0-1106420-3
Steckergehäuse: Kabeleingang seitlich, Keilform Hood: Side entry, Standard construction 	M25	16	HB-KF/K-Z.6.STS-ZB.1.16.G HB-KF/K-Z.6.STS-ZB.1.M25.G	2-1102205-3 0-1106420-2
Anbaugehäuse: Kabeleingang unten Surface mounted housing: Bottom entry 			HB-Z.6.AG-ZVGR Mit Korrosionsschutz With corrosion protection	1-1102244-8 2-1102244-8

Passende Kabelverschraubungen ab Seite 188/Suitable Cable fittings from page 188

HB-Z.6, HB-K/Z.6, HD-Z.16, HD-K/Z.16 Gehäuse/Housings

Baugröße/Size 3

Pulverbeschichtet, silbergrau/K = korrosionsgeschützt, schwarz

Powder-coated, silver-grey/K = corrosion-resistant, black

Zentralbügel am Steckergehäuse/Central locking clip on hood

IP 65

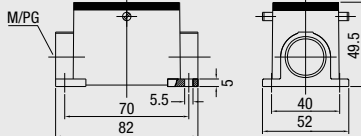
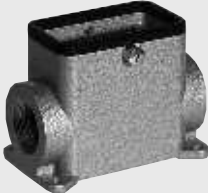
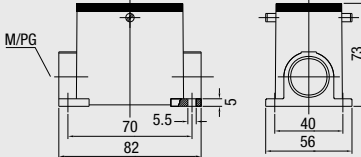
Bezeichnung Description	Metr.	PG	Bestelltext Designation	Bestell-Nr. Order No.
Sockelgehäuse: Kabeleingang seitlich, Standard Bauform <i>Surface mounted housing: Side entry, Standard construction</i>  	M25	16 2x16	HB-Z.6.SG-ZVGR.1.16.Z HB-Z.6.SG-ZVGR.2.16.Z HB-Z.6.SG-ZVGR.2.M25.Z Mit Korrosionsschutz <i>With corrosion protection</i>	1-1102249-8 1-1102251-8 0-1106418-6
		16 2x16	HB-K/Z.6.SG-ZVGR.1.16.Z HB-K/Z.6.SG-ZVGR.2.16.Z HB-K/Z.6.SG-ZVGR.2.M25.Z	2-1102249-8 2-1102251-8 0-1106418-5
Sockelgehäuse: Kabeleingang seitlich, Hohe Bauform <i>Surface mounted housing: Side entry, High construction</i>  	2xM32	21 2x21	HD-Z.16.SG-ZVGR.1.21.Z HD-Z.16.SG-ZVGR.2.21.Z HD-Z.16.SG-ZVGR.2.M32.Z Mit Korrosionsschutz <i>With corrosion protection</i>	1-1102472-8 1-1102474-8 0-1106422-5
		21 2x21	HD-K/Z.16.SG-ZVGR.1.21.Z HD-K/Z.16.SG-ZVGR.2.21.Z HD-K/Z.16.SG-ZVGR.2.M32.Z	2-1102472-8 2-1102474-8 1-1106469-1

Passende Kabelverschraubungen ab Seite 188/Suitable Cable fittings from page 188

HIP.6/16, HIP-K.6/16, EMV-K.6/16 Gehäuse/Housings

Baugröße/Size 3

HIP: Druckdicht, silbergrau, **HIP-K:** Korrosionsgeschützt, schwarz







EMV-K: Schutz gegen elektromagnetische Beeinflussung, druckdicht, korrosionsgeschützt, schwarz

HIP: Pressure-tight, silver-grey, **HIP-K:** Housings corrosion-resistant, black

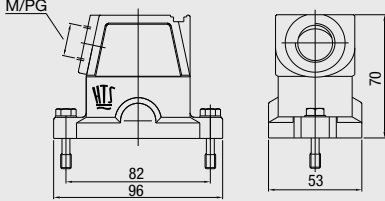
EMV-K: Protection against electro-magnetic interference, pressure-tight, housings corrosion-resistant, black

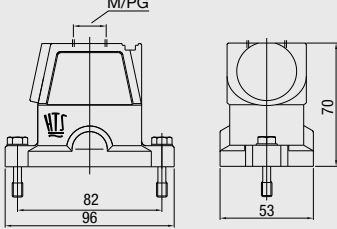
Schraubverriegelung am Oberteil/Screw lock on hood

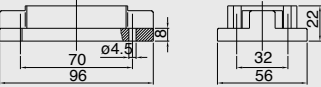
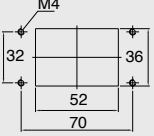
IP 68

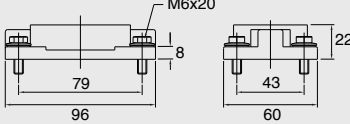
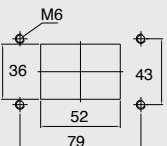
Bezeichnung Description	Metr.	PG	Bestelltext Designation	Bestell-Nr. Order No.
Steckergehäuse: Kabeleingang seitlich Hood: Side entry  	M25	16	HIP HIP.6/16.STS.1.16.G HIP.6/16.STS.1.M25.G	1-1102631-5 0-1106425-2
	M25	16 21	HIP-K HIP-K.6/16.STS.1.16.G HIP-K.6/16.STS.1.21.G HIP-K.6/16.STS.1.M25.G	2-1102631-5 2-1102633-5 0-1106425-4
	M25	16	EMV-K EMV-K.6/16.STS.1.16.G EMV-K.6/16.STS.1.M25.G	4-1102704-5 0-1106416-4
Steckergehäuse: Kabeleingang oben Hood: Top entry  	M32	16	HIP HIP.6/16.STO.1.16.G HIP.6/16.STO.1.M32.G	1-1102635-5 0-1106425-1
	M25 M32	16 21	HIP-K HIP-K.6/16.STO.1.16.G HIP-K.6/16.STO.1.21.G HIP-K.6/16.STO.1.M25.G HIP-K.6/16.STO.1.M32.G	2-1102635-5 2-1102637-5 0-1106425-6 0-1106425-3
	M32	13 16 21	EMV-K EMV-K.6/16.STO.1.13.G EMV-K.6/16.STO.1.16.G EMV-K.6/16.STO.1.21.G EMV-K.6/16.STO.1.M32.G	0-1108719-1 4-1102706-5 4-1102707-5 0-1106416-3
	M32	21	HIP HIP.6/16.AG	1-1102638-5
Anbaugehäuse: Kabeleingang unten Surface mounted housing: Bottom entry   <p>Montageausschnitt/Panel cut-out</p> 			HIP-K HIP-K.6/16.AG	2-1102638-5
			EMV-K EMV-K.6/16.AG	4-1102710-5
	Anbaugehäuse: Kabeleingang unten Surface mounted housing: Bottom entry   <p>Montageausschnitt/Panel cut-out</p> 			HIP HIP.6/16.AG.M6
			HIP-K HIP-K.6/16.AG.M6	2-1102606-5
			EMV-K EMV-K.6/16.AG.M6	4-1102712-5

Passende Kabelverschraubungen ab Seite 188/Suitable Cable fittings from page 188

HIP.6/16, HIP-K.6/16, EMV-K.6/16 Gehäuse/Housings

Baugröße/Size 3

HIP: Druckdicht, silbergrau, **HIP-K:** Korrosionsgeschützt, schwarz

EMV-K: Schutz gegen elektromagnetische Beeinflussung, druckdicht, korrosionsgeschützt, schwarz

HIP: Pressure-tight, silver-grey, **HIP-K:** Housings corrosion-resistant, black

EMV-K: Protection against electro-magnetic interference, pressure-tight, housings corrosion-resistant, black

Schraubverriegelung am Oberteil/Screw lock on hood

IP 68

Bezeichnung Description	Metr.	PG	Bestelltext Designation	Bestell-Nr. Order No.
Sockelgehäuse: Kabeleingang seitlich Surface mounted housing: Side entry				
	2xM32	16 2x16	HIP HIP.6/16.SG.1.16.G HIP.6/16.SG.2.16.G HIP.6/16.SG.2.M32.G	1-1102604-5 1-1102605-5 0-1106424-1
Schutzkappe für Gehäuse-Unterteile Protective covers for housings	2xM25 2xM32	16 2x16	HIP-K HIP-K.6/16.SG.1.16.G HIP-K.6/16.SG.2.16.G HIP-K.6/16.SG.2.M25.G HIP-K.6/16.SG.2.M32.G	2-1102604-5 2-1102605-5 0-1102942-1 0-1106424-2
	2xM25 2xM32	16 2x16	EMV-K EMV-K.6/16.SG.1.16.G EMV-K.6/16.SG.2.16.G EMV-K.6/16.SG.2.M25.G EMV-K.6/16.SG.2.M32.G	5-1102708-5 5-1102709-5 0-1106413-3 0-1106415-2
			HIP HIP/EMV.6/16.SKB	3-1106201-5
			HIP-K HIP-K/EMV-K.6/16.SKB	4-1106201-5
			EMV-K HIP-K/EMV-K.6/16.SKB	4-1106201-5

Passende Kabelverschraubungen ab Seite 188/Suitable Cable fittings from page 188

HE.10 Kontakteinsätze/Contact inserts

Baugröße/Size 4

Schraubanschluss, Federzug-Anschluss,
Crimpschluss für gedrehte HE/HA Crimpkontakte

**Kontaktzahlen
No. of contacts**

*Screw terminal, Spring Clamp terminal,
Crimp terminal for screw machined HE/HA crimp contacts*

10 +

400 V/16 A

Bezeichnung Description	Bestelltext Designation	Bestell-Nr./Order No.	
		Stifteinsatz Male insert	Buchseinsatz Female insert
<p>Stifteinsatz/Male insert</p> <p>Schraubanschluss/Screw terminal</p>	HE.10.Sti.S	1-1103636-1	
<p>Buchseinsatz/Female insert</p>	HE.10.Bu.S		1-1103637-1
<p>Federzug-Anschluss/Spring Clamp terminal</p>	HE.10.Sti.SC	7-1103636-1	
	HE.10.Bu.SC		7-1103637-1
<p>Crimpschluss/Crimp terminal</p>	HE.10.Sti.C	2-1103636-3	
	HE.10.Bu.C		2-1103637-3

Maße/Dimensions	A	B	C	D	E
mm	57	63	33	34	35

Passende Crimpkontakte siehe Seite 37, Passende Crimpwerkzeuge siehe Seite 37
 Suitable Crimp contacts see page 37, Suitable Crimping tools see page 37

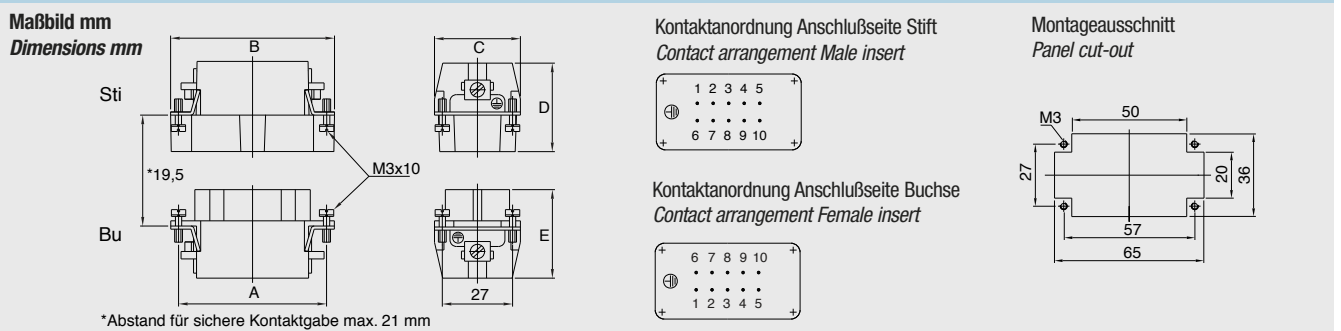

HEE.18 Kontakteinsätze/Contact inserts

Baugröße/Size 4



Crimpanschluss für gedrehte HE Crimpkontakte

**Kontaktzahlen
No. of contacts**

Crimp terminal for screw machined HE crimp contacts

18 +

500 V/16 A

Bezeichnung Description		Bestelltext Designation	Bestell-Nr./Order No.													
Stifteinsatz/Male insert	Buchseinsatz/Female insert		Stifteinsatz Male insert	Buchseinsatz Female insert												
Crimpanschluss/Crimp terminal																
		HEE.18.Sti.C HEE.18.Sti.C.FS*	0-1102897-1 0-1102897-2													
		HEE.18.Bu.C HEE.18.Bu.C.FS*		0-1102898-1 0-1102898-2												
<p>*Kunststoff ist I2F1 qualifiziert nach NF-F 16-101, 102 Plastic is qualified I2F1 according NF-F 16-101, 102</p>																
<table border="1"> <thead> <tr> <th>Maße/Dimensions</th> <th>A</th> <th>B</th> <th>C</th> <th>D</th> <th>E</th> </tr> </thead> <tbody> <tr> <td>mm</td> <td>57</td> <td>63</td> <td>33</td> <td>34</td> <td>37</td> </tr> </tbody> </table>		Maße/Dimensions	A	B	C	D	E	mm	57	63	33	34	37			
Maße/Dimensions	A	B	C	D	E											
mm	57	63	33	34	37											

Passende Crimpkontakte siehe Seite 37, Passende Crimpwerkzeuge siehe Seite 37
Suitable Crimp contacts see page 37, Suitable Crimping tools see page 37

**Maßbild mm
Dimensions mm**

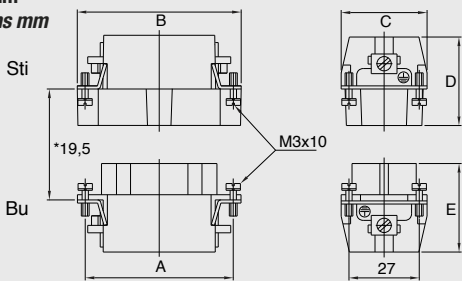

*Abstand für sichere Kontaktgabe max. 21 mm

**Kontaktanordnung Anschlußseite Stift
Contact arrangement Male insert**

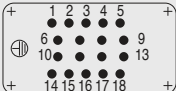

**Kontaktanordnung Anschlußseite Buchse
Contact arrangement Female insert**

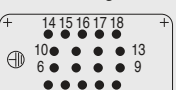

**Montageausschnitt
Panel cut-out**

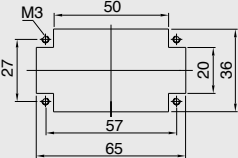

HVT.14 Kontakteinsätze/Contact inserts **Baugröße/Size 4**



Crimpanschluss für gedrehte HVT Crimpkontakte

Kontaktzahlen
No. of contacts

Crimp terminal for screw machined HVT crimp contacts

14 +

400 V/16 A

Bezeichnung Description	Bestelltext Designation	Bestell-Nr./Order No.	
		Stifteinsatz Male insert	Buchseinsatz Female insert
<p>Stifteinsatz/Male insert</p> <p>Crimpanschluss/Crimp terminal</p> 	HVT.14.Sti.C	2-1104004-3	
<p>Buchseinsatz/Female insert</p> 	HVT.14.Bu.C		2-1104006-3

Maße/Dimensions	A	B	C	D	E
mm	57	63	33	35	40

Passende Crimpkontakte siehe Seite 38, Passende Crimpwerkzeuge siehe Seite 38
 Suitable Crimp contacts see page 38, Suitable Crimping tools see page 38

Maßbild mm
Dimensions mm

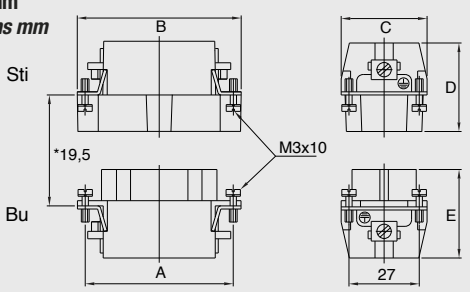

*Abstand für sichere Kontaktgabe max. 21 mm

Kontaktanordnung Anschlußseite Stift
Contact arrangement Male insert

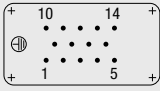

Kontaktanordnung Anschlußseite Buchse
Contact arrangement Female insert

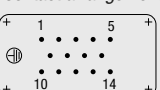

Montageausschnitt
Panel cut-out

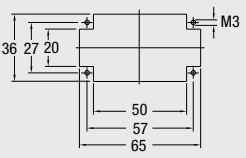

HD.24 Kontakteinsätze/Contact inserts

Baugröße/Size 4

Crimpanschluss für gestanzte HD-M Crimpkontakte

**Kontaktzahlen
No. of contacts**

Crimp terminal for stamped HD-M crimp contacts

24 +

250 V/10 A

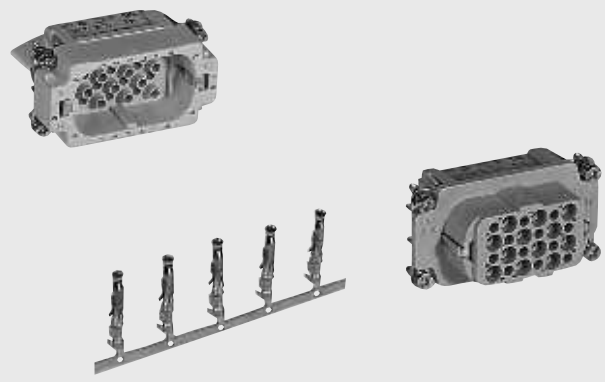
Bezeichnung Description	Bestelltext Designation	Bestell-Nr./Order No.	
		Stifteinsatz Male insert	Buchseinsatz Female insert
<p>Stifteinsatz/Male insert</p> <p>Crimpanschluss/Crimp terminal</p> 	HD.24.Sti.C	2-1103008-3	
<p>Buchseinsatz/Female insert</p>	HD.24.BU.C		2-1103009-3

Maße/Dimensions	A	B	C	D	E
mm	57	64	33	35	35

Passende Crimpkontakte siehe Seite 35, Passende Crimpwerkzeuge siehe Seite 35
 Suitable Crimp contacts see page 35, Suitable Crimping tools see page 35

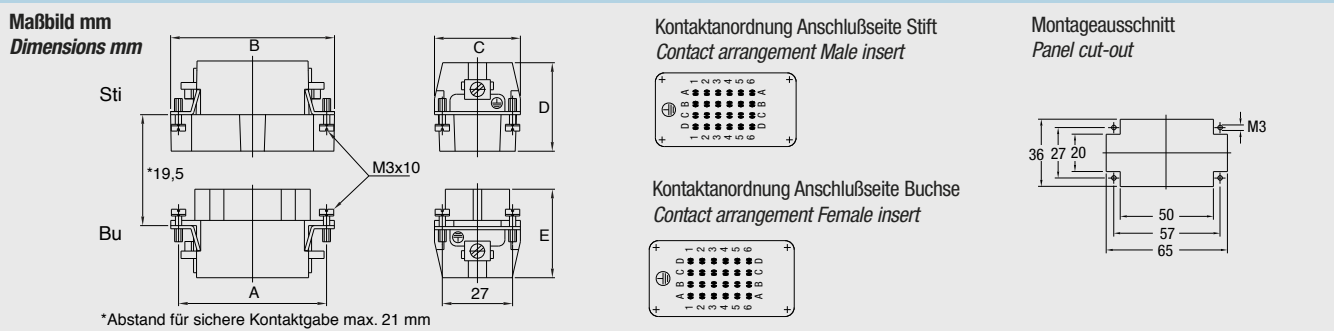

HN.2D.42; HMX8/24 Kontakteinsätze/Contact inserts

Baugröße/Size 4

Crimpanschluss für gedrehte HN.D/HE Crimpkontakte

Kontaktzahlen

No. of contacts

Crimp terminal for screw machined HN.D/HE crimp contacts

42; 8/24 +

250 V/10 A; 400V/16A + 250V/10A

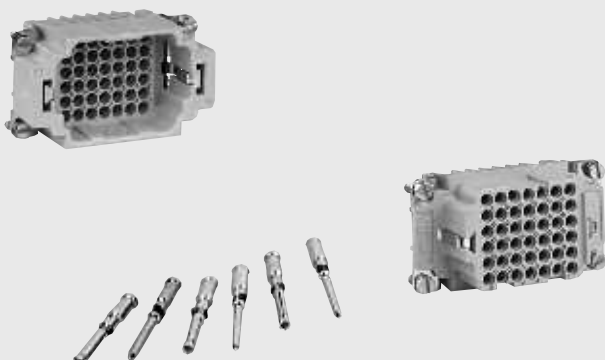
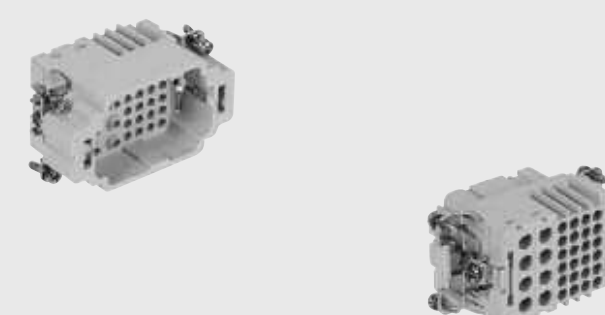
Bezeichnung Description	Bestelltext Designation	Bestell-Nr./Order No.	
		Stifteinsatz Male insert	Buchseinsatz Female insert
<p>Stifteinsatz/Male insert</p> <p>Buchseinsatz/Female insert</p> <p>Crimpanschluss/Crimp terminal</p>  <p>Passende Crimpkontakte siehe Seite 34 Suitable Crimp contacts see page 34</p>	<p>HN.2D.42.Sti.C</p> <p>HN.2D.42.Bu.C</p>	<p>2-1103204-3</p> <p>2-1103206-3</p>	
 <p>Passende Crimpkontakte Power siehe Seite 37, passende Crimpkontakte Signal siehe Seite 34 Suitable Crimp contacts power see page 37, suitable Crimp contacts signal see page 34</p>	<p>HMX.8/24.Sti.C</p> <p>HMX.8/24.Bu.C</p>	<p>0-1103089-1</p> <p>0-1103090-1</p>	

Maße/Dimensions	A	B	C	D	E
mm	57	63	34	35,5	37

Maßbild mm/Dimensions mm

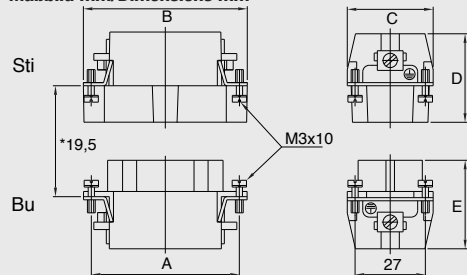

*Abstand für sichere Kontaktgabe max. 21 mm

**Kontaktanordnung Anschlußseite Stift
Contact arrangement Male insert**



**Kontaktanordnung Anschlußseite Buchse
Contact arrangement Female insert**



**Montageausschnitt
Panel cut-out**

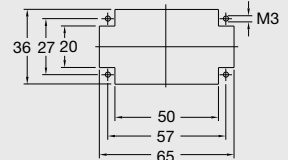

Modul Halterahmen/Module Fixing Frame

Baugröße/Size 4

Bezeichnung
Description

Bestelltext
Designation

Bestell-Nr./Order No.
Oberteil
Top part

Unterteil
Bottom part

Halterahmen/*Fixing frame*



Für Modul MDL Seite 194–203
For module MDL page 194–203

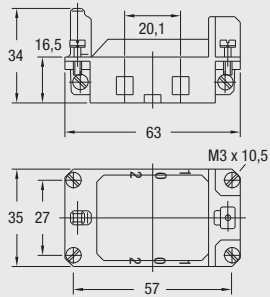

MDL2-GR.0-4/B.1-2

0-1108783-1

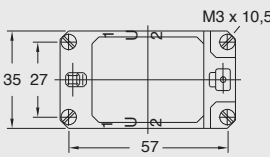

MDL2-GR.U-4/B.1-2

0-1108783-2

Montageausschnitt/*Panel cut-out*

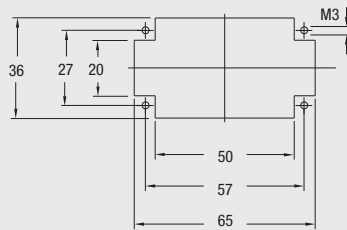

Halterahmen/*Fixing frame*

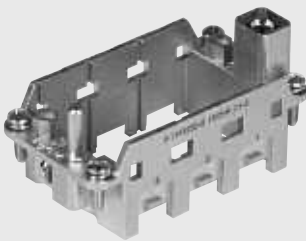

Für Modul HVS Seite 204–212
For module HVS page 204–212

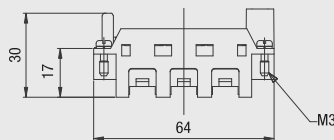

HVS-R.0 1-3
HVS-R.U 1-3

0-1103250-5

0-1103250-6

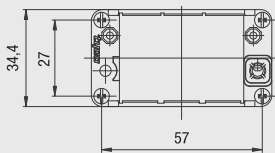

Montageausschnitt/*Panel cut-out*

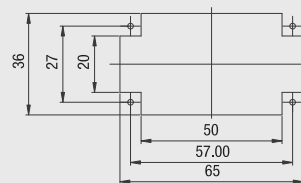

HB.10, HB-K.10, HD.24, HD-K.24 Gehäuse/Housings









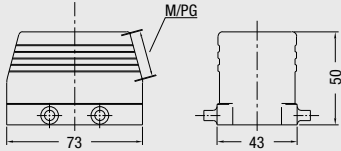

Baugröße/Size 4

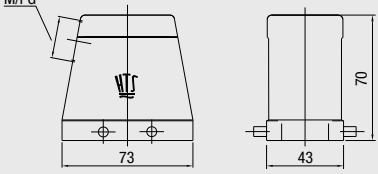
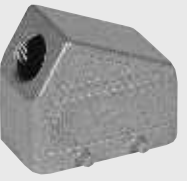
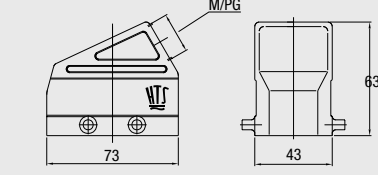
Pulverbeschichtet, silbergrau
 K = korrosionsgeschützt, schwarz

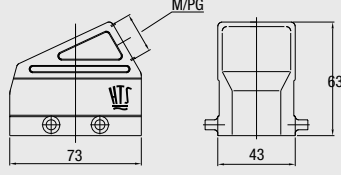
Powder-coated, silver-grey
K = corrosion-resistant, black

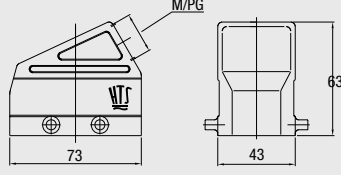
Verschlussbügel am Unterteil/Locking clip at housing bottom

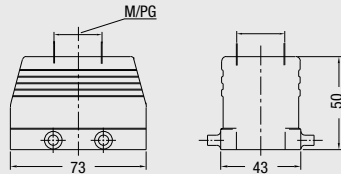
IP 65

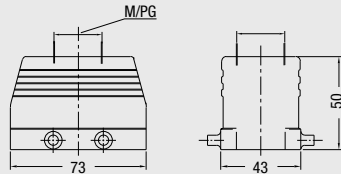
Bezeichnung Description	Metr.	PG	Bestelltext Designation	Bestell-Nr. Order No.
Steckergehäuse: Kabeleingang seitlich, Standard Bauform Hood: Side entry, Standard construction  	M20 M25	16	HB.10.STS.1.16.G	1-1102261-6
		21	HB.10.STS.1.21.G HB.10.STS.1.M20.G HB.10.STS.1.M25.G	1-1102264-6 2-1106430-4 0-1106430-4
Steckergehäuse: Kabeleingang seitlich, Hohe Bauform Hood: Side entry, High construction  	M25	16	HB-K.10.STS.1.16.G	2-1102261-6
		21	HB-K.10.STS.1.21.G HB-K.10.STS.1.M25.G	2-1102264-6 1-1106430-0
Steckergehäuse: Kabeleingang seitlich, Keilform Hood: Side entry, Standard construction  	M32	21	HD.24.STS.1.21.G	1-1102496-6
		29	HD.24.STS.1.29.G HD.24.STS.1.M32.G	1-1102499-6 0-1106434-4
		21	HD-K.24.STS.1.21.G	2-1102496-6
Steckergehäuse: Kabeleingang oben, Standard Bauform Hood: Top entry, Standard construction  	M25	29	HD-K.24.STS.1.29.G	2-1102499-6
		16	HB-KF.10.STS.1.16.G HB-KF.10.STS.1.21.G HB-KF.10.STS.1.M25.G	1-1102211-6 1-1102214-6 0-1106431-1
Steckergehäuse: Kabeleingang oben, Standard Bauform Hood: Top entry, Standard construction  	M25	21	HB-KF/K.10.STS.1.16.G HB-KF/K.10.STS.1.21.G HB-KF/K.10.STS.1.M25.G	2-1102211-6 2-1102214-6 0-1106431-5
		16	HB.10.STO.1.16.G HB.10.STO.1.21.G HB.10.STO.1.M25.G	1-1102267-6 1-1102270-6 0-1106430-1
Steckergehäuse: Kabeleingang oben, Hohe Bauform Hood: Top entry, High construction  	M25	16	HB.10.STO.1.16.G HB.10.STO.1.21.G HB.10.STO.1.M25.G	1-1102267-6 2-1102270-6 0-1106430-7
		21	HB-K.10.STO.1.16.G HB-K.10.STO.1.21.G HB-K.10.STO.1.M25.G	2-1102267-6 2-1102270-6 0-1106430-7
Steckergehäuse: Kabeleingang oben, Hohe Bauform Hood: Top entry, High construction  	M32	21	HD.24.STO.1.21.G	1-1102502-6
		29	HD.24.STO.1.29.G HD.24.STO.1.M32.G	1-1102505-6 0-1106434-1
		21	HD-K.24.STO.1.21.G HD-K.24.STO.1.29.G HD-K.24.STO.1.M32.G	2-1102502-6 2-1102505-6 0-1106434-7

Passende Kabelverschraubungen ab Seite 188/Suitable Cable fittings from page 188

HB.10, HB-K.10, HD.24, HD-K.24, Gehäuse/Housings **Baugröße/Size 4**

Pulverbeschichtet, silbergrau
K = korrosionsgeschützt, schwarz

Powder-coated, silver-grey
K = corrosion-resistant, black

Verschlussbügel am Unterteil/Locking clip at housing bottom **IP 65**

Bezeichnung Description	Metr.	PG	Bestelltext Designation	Bestell-Nr. Order No.
<p>Anbaugehäuse: Kabeleingang unten, Standard Bauform <i>Surface mounted housing: Bottom entry, Standard construction</i></p>			<p>HB.10.AG-VS Mit Korrosionsschutz <i>With corrosion protection</i> HB-K.10.AG-VS</p>	<p>1-1102271-1 2-1102271-1</p>
<p>Sockelgehäuse: Kabeleingang seitlich, Standard Bauform <i>Surface mounted housing: Side entry, Standard construction</i></p>	M25 2xM25	16 2x16	<p>HB.10.SG-VS.1.16.Z HB.10.SG-VS.2.16.Z HB.10.SG-VS.1.M25.Z HB.10.SG-VS.2.M25.Z Mit Korrosionsschutz <i>With corrosion protection</i></p>	<p>1-1102274-1 1-1102276-1 0-1103059-1 0-1106429-4</p>
<p>Sockelgehäuse: Kabeleingang seitlich, Hohe Bauform <i>Surface mounted housing: Side entry, High construction</i></p>	2xM32	21 29 2x21 2x29	<p>HD.24.SG-VS.1.21.Z HD.24.SG-VS.1.29.Z HD.24.SG-VS.2.21.Z HD.24.SG-VS.2.29.Z HD.24.SG-VS.2.M32.Z Mit Korrosionsschutz <i>With corrosion protection</i></p>	<p>1-1102507-1 1-1102511-1 1-1102509-1 1-1102513-1 0-1106433-4</p>
	2xM32	21 29 2x21	<p>HD-K.24.SG-VS.1.21.Z HD-K.24.SG-VS.1.29.Z HD-K.24.SG-VS.2.21.Z HD-K.24.SG-VS.2.M32.Z</p>	<p>2-1102507-1 2-1102511-1 2-1102509-1 0-1106433-8</p>

Passende Kabelverschraubungen ab Seite 188/Suitable Cable fittings from page 188

HB.10, HB-K.10, HD.24, HD-K.24, Gehäuse/Housings







Baugröße/Size 4

Pulverbeschichtet, silbergrau
 K = korrosionsgeschützt, schwarz

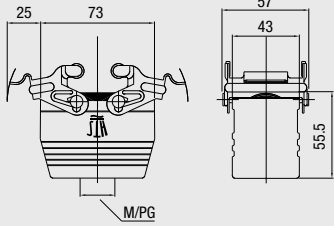
Powder-coated, silver-grey
K = corrosion-resistant, black

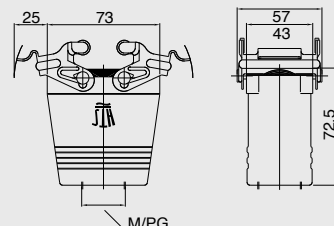
Verschlussbügel am Unterteil/Locking clip at housing bottom

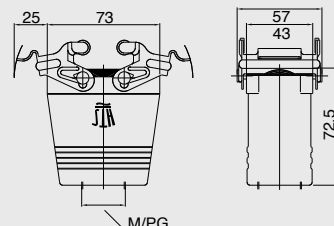
IP 65

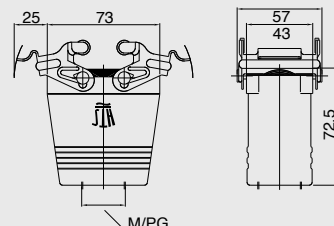
Bezeichnung Description	Metr.	PG	Bestelltext Designation	Bestell-Nr. Order No.
<p>Kupplungsgehäuse: Kabeleingang unten, Standard Bauform <i>Cable-to-cable hood: Bottom entry, Standard construction</i></p>  	M25	16 21	HB.10.KDO-VS.1.16.G HB.10.KDO-VS.1.21.G HB.10.KDO-VS.1.M25.G Mit Korrosionsschutz <i>With corrosion protection</i>	1-1102279-1 1-1102282-1 0-1106428-2
<p>Kupplungsgehäuse: Kabeleingang unten, Hohe Bauform <i>Cable-to-cable hood: Bottom entry, High construction</i></p>  	M25	16	HB-K.10.KDO-VS.1.16.G HB-K.10.KDO-VS.1.M25.G	2-1102279-1 0-1106428-4
<p>Kupplungsgehäuse: Kabeleingang unten, Hohe Bauform <i>Cable-to-cable hood: Bottom entry, High construction</i></p>  	M32		HD.24.KDO-VS.1.M32.G Mit Korrosionsschutz <i>With corrosion protection</i>	0-1106432-2
<p>Kupplungsgehäuse: Kabeleingang unten, Hohe Bauform <i>Cable-to-cable hood: Bottom entry, High construction</i></p>  	M32		HD-K.24.KDO-VS.1.M32.G	0-1106432-4

Passende Kabelverschraubungen ab Seite 188/Suitable Cable fittings from page 188

HB.10, HB-K.10, HD.24, HD-K.24, Gehäuse/Housings

Baugröße/Size 4

Pulverbeschichtet, silbergrau
 K = korrosionsgeschützt, schwarz

Powder-coated, silver-grey
K = corrosion-resistant, black

Verschlussbügel am Oberteil/Locking clip at hood

IP 65

Bezeichnung Description	Metr.	PG	Bestelltext Designation	Bestell-Nr. Order No.
<p>Steckergehäuse: Kabeleingang seitlich, Standard Bauform <i>Hood:</i> Side entry, Standard construction</p>	M25	16	HB.10.STS-VS.1.16.G HB.10.STS-VS.1.M25.G Mit Korrosionsschutz <i>With corrosion protection</i>	1-1102261-1 0-1106430-6
<p>Steckergehäuse: Kabeleingang seitlich, Hohe Bauform <i>Hood:</i> Side entry, High construction</p>	M25	16	HB-K.10.STS-VS.1.16.G HB-K.10.STS-VS.1.M25.G	2-1102261-1 1-1106430-2
<p>Steckergehäuse: Kabeleingang seitlich, Keilform <i>Hood:</i> Side entry, Standard construction</p>	M25	21 29	HD.24.STS-VS.1.21.G HD.24.STS-VS.1.29.G HD.24.STS-VS.1.M25.G HD.24.STS-VS.1.M32.G Mit Korrosionsschutz <i>With corrosion protection</i>	1-1102496-1 1-1102499-1 1-1106434-5 0-1106434-3
<p>Steckergehäuse: Kabeleingang seitlich, Keilform <i>Hood:</i> Side entry, Standard construction</p>	M32	21 29	HD-K.24.STS-VS.1.21.G HD-K.24.STS-VS.1.29.G HD-K.24.STS-VS.1.M32.G	2-1102496-1 2-1102499-1 0-1106434-6
<p>Steckergehäuse: Kabeleingang oben, Standard Bauform <i>Hood:</i> Top entry, Standard construction</p>	M25	16	HB-KF.10.STS-VS.1.16.G HB-KF.10.STS-VS.1.M25.G Mit Korrosionsschutz <i>With corrosion protection</i>	1-1102211-1 0-1106431-3
<p>Steckergehäuse: Kabeleingang oben, Standard Bauform <i>Hood:</i> Top entry, Standard construction</p>	M25	16	HB-KF/K.10.STS-VS.1.16.G HB-KF/K.10.STS-VS.1.M25.G	2-1102211-1 0-1106431-7
<p>Steckergehäuse: Kabeleingang oben, Standard Bauform <i>Hood:</i> Top entry, Standard construction</p>	M25	16	HB.10.STO-VS.1.16.G HB.10.STO-VS.1.M25.G Mit Korrosionsschutz <i>With corrosion protection</i>	1-1102267-1 0-1106430-3
<p>Steckergehäuse: Kabeleingang oben, Standard Bauform <i>Hood:</i> Top entry, Standard construction</p>	M25	16	HB-K.10.STO-VS.1.16.G HB-K.10.STO-VS.1.M25.G	2-1102267-1 0-1106430-9
<p>Steckergehäuse: Kabeleingang oben, Hohe Bauform <i>Hood:</i> Top entry, High construction</p>	M32	29	HD.24.STO-VS.1.29.G HD.24.STO-VS.1.M32.G Mit Korrosionsschutz <i>With corrosion protection</i>	1-1102505-1 0-1106434-3
<p>Steckergehäuse: Kabeleingang oben, Hohe Bauform <i>Hood:</i> Top entry, High construction</p>	M32	21 29	HD-K.24.STO-VS.1.21.G HD-K.24.STO-VS.1.29.G HD-K.24.STO-VS.1.M32.G	2-1102502-1 2-1102505-1 0-1106434-9

Passende Kabelverschraubungen ab Seite 188/Suitable Cable fittings from page 188

HB.10, HB-K.10, HD.24, HD-K.24, Gehäuse/Housings

Baugröße/Size 4

Pulverbeschichtet, silbergrau
 K = korrosionsgeschützt, schwarz

Powder-coated, silver-grey
K = corrosion-resistant, black

Verschlussbügel am Oberteil/Locking clip at hood

IP 65

Bezeichnung Description	Metr.	PG	Bestelltext Designation	Bestell-Nr. Order No.
<p>Anbaugehäuse: Kabeleingang unten, Standard Bauform <i>Surface mounted housing: Bottom entry, Standard construction</i></p>			HB.10.AGD Mit Korrosionsschutz <i>With corrosion protection</i> HB-K.10.AGD	1-1102283-6 2-1102283-6
<p>Sockelgehäuse: Kabeleingang seitlich, Standard Bauform <i>Surface mounted housing: Side entry, Standard construction</i></p>	M25 2xM25	16 2x16	HB.10.SGD.1.16.Z HB.10.SGD.2.16.Z HB.10.SGD.1.M25.Z HB.10.SGD.2.M25.Z Mit Korrosionsschutz <i>With corrosion protection</i>	1-1102286-6 1-1102288-6 0-1103059-2 0-1106429-1
<p>Sockelgehäuse: Kabeleingang seitlich, Hohe Bauform <i>Surface mounted housing: Side entry, High construction</i></p>	2xM32 2xM32	2x21 2x29	HD.24.SGD.2.21.Z HD.24.SGD.2.M32.Z Mit Korrosionsschutz <i>With corrosion protection</i> HD-K.24.SGD.2.29.Z HD-K.24.SGD.2.M32.Z	1-1102523-6 0-1106433-1 2-1102527-6 0-1106433-5

Passende Kabelverschraubungen ab Seite 188/Suitable Cable fittings from page 188

HB.10, HB-K.10, HD.24, HD-K.24, Gehäuse/Housings







Baugröße/Size 4

Pulverbeschichtet, silbergrau
 K = korrosionsgeschützt, schwarz

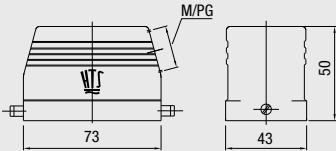
Powder-coated, silver-grey
K = corrosion-resistant, black

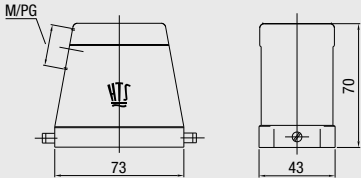
Längsbügel am Unterteil/Side clip at housing bottom

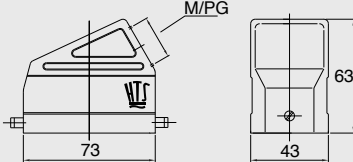
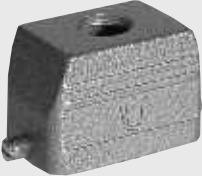
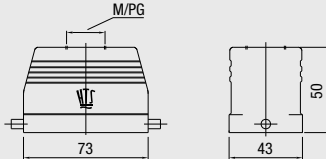
IP 65

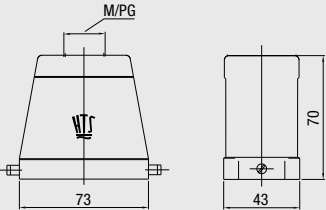
Bezeichnung Description	Metr.	PG	Bestelltext Designation	Bestell-Nr. Order No.
Steckergehäuse: Kabeleingang seitlich, Standard Bauform <i>Hood:</i> Side entry, Standard construction  	M25	16	HB.10.STS-GR.1.16.G HB.10.STS-GR.1.M25.G	1-1102261-7 0-1106430-5
	M25	16	Mit Korrosionsschutz <i>With corrosion protection</i> HB-K.10.STS-GR.1.16.G HB-K.10.STS-GR.1.M25.G	2-1102261-7 1-1106430-1
Steckergehäuse: Kabeleingang seitlich, Hohe Bauform <i>Hood:</i> Side entry, High construction  	M32	29 21	HD.24.STS-GR.1.29.G HD.24.STS-GR.1.21.G HD.24.STS-GR.1.M32.G	1-1102499-7 1-1102496-7 0-1106434-5
	M32	21	Mit Korrosionsschutz <i>With corrosion protection</i> HD-K.24.STS-GR.1.21.G HD-K.24.STS-GR.1.M32.G	2-1102496-7 1-1106434-1
Steckergehäuse: Kabeleingang seitlich, Keilform <i>Hood:</i> Side entry, Standard construction  	M25	16	HB-KF.10.STS-GR.1.16.G HB-KF.10.STS-GR.1.M25.G	1-1102211-7 0-1106431-2
	M25	16	Mit Korrosionsschutz <i>With corrosion protection</i> HB-KF/K.10.STS-GR.1.16.G HB-KF/K.10.STS-GR.1.M25.G	2-1102211-7 0-1106431-7
Steckergehäuse: Kabeleingang oben, Standard Bauform <i>Hood:</i> Top entry, Standard construction  	M25	16	HB.10.STO-GR.1.16.G HB.10.STO-GR.1.M25.G	1-1102267-7 0-1106430-2
	M25	16	Mit Korrosionsschutz <i>With corrosion protection</i> HB-K.10.STO-GR.1.16.G HB-K.10.STO-GR.1.M25.G	2-1102267-7 0-1106430-8
Steckergehäuse: Kabeleingang oben, Hohe Bauform <i>Hood:</i> Top entry, High construction  	M32	21 29	HD.24.STO-GR.1.21.G HD.24.STO-GR.1.29.G HD.24.STO-GR.1.M32.G	1-1102502-7 1-1102505-7 0-1106434-2
	M32	29	Mit Korrosionsschutz <i>With corrosion protection</i> HD-K.24.STO-GR.1.29.G HD-K.24.STO-GR.1.M32.G	2-1102505-7 0-1106434-8

Passende Kabelverschraubungen ab Seite 188/Suitable Cable fittings from page 188

HB.10, HB-K.10, HD.24, HD-K.24, Gehäuse/Housings





Baugröße/Size 4

Pulverbeschichtet, silbergrau
 K = korrosionsgeschützt, schwarz

Powder-coated, silver-grey
K = corrosion-resistant, black

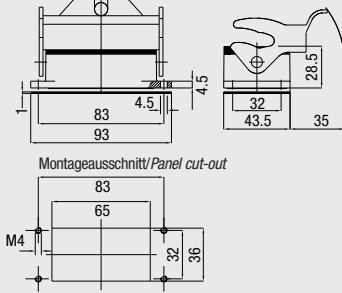
Längsbügel am Unterteil/Side clip at housing bottom

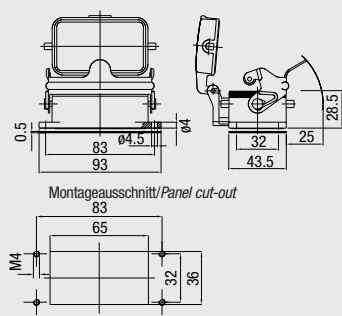
IP 65

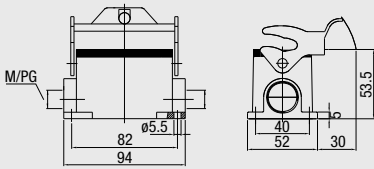
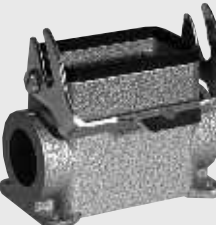
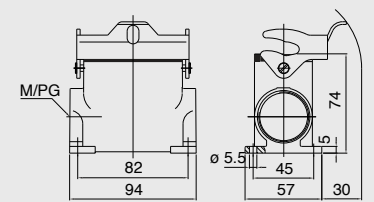
Bezeichnung Description	Metr.	PG	Bestelltext Designation	Bestell-Nr. Order No.
<p>Anbaugehäuse: Kabeleingang unten, Standard Bauform <i>Surface mounted housing: Bottom entry, Standard construction</i></p>  			HB.10.AG-LB Mit Korrosionsschutz <i>With corrosion protection</i> HB-K.10.AG-LB	1-1102271-2 2-1102271-2
<p>Anbaugehäuse: Kabeleingang unten, Standard Bauform <i>Surface mounted housing: Bottom entry, Standard construction</i></p>  			HB.10.AGD-LB Mit Korrosionsschutz <i>With corrosion protection</i> HB-K.10.AGD-LB	1-1102283-2 2-1102283-2
<p>Sockelgehäuse: Kabeleingang seitlich, Standard Bauform <i>Surface mounted housing: Side entry, Standard construction</i></p>  	2xM25	16 2x16	HB.10.SG-LB.1.16.Z HB.10.SG-LB.2.16.Z HB.10.SG-LB.2.M25.Z Mit Korrosionsschutz <i>With corrosion protection</i> HB-K.10.SG-LB.1.16.Z HB-K.10.SG-LB.2.M25.Z	1-1102274-2 1-1102276-2 0-1106429-3 2-1102274-2 0-1106429-7
<p>Sockelgehäuse: Kabeleingang seitlich, Hohe Bauform <i>Surface mounted housing: Side entry, High construction</i></p>  	2xM32	21 2x21 29 2x29	HD.24.SG-LB.1.21.Z HD.24.SG-LB.2.21.Z HD.24.SG-LB.1.29.Z HD.24.SG-LB.2.29.Z HD.24.SG-LB.2.M32.Z Mit Korrosionsschutz <i>With corrosion protection</i> HD-K.24.SG-LB.2.M32.Z	1-1102507-2 1-1102509-2 1-1102511-2 1-1102513-2 0-1106433-3 0-1106433-7

Passende Kabelverschraubungen ab Seite 188/Suitable Cable fittings from page 188

HB.10, HB-K.10, HD.24, HD-K.24, Gehäuse/Housings











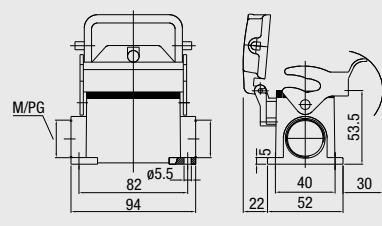

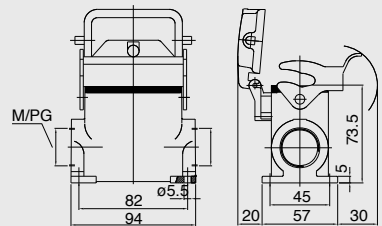
Baugröße/Size 4

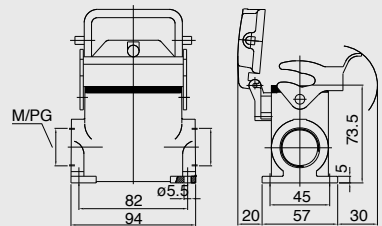
Pulverbeschichtet, silbergrau
 K = korrosionsgeschützt, schwarz

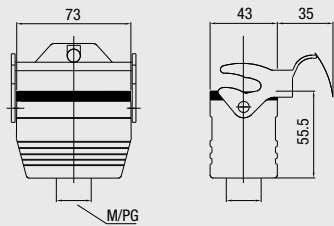
Powder-coated, silver-grey
K = corrosion-resistant, black

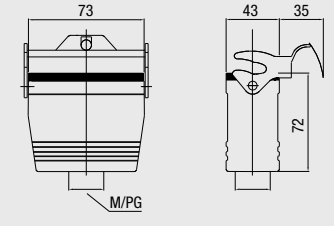
Längsbügel am Unterteil/Side clip at housing bottom

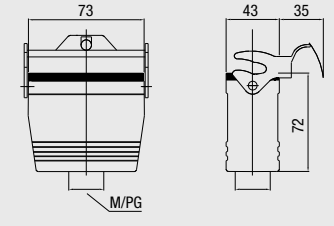
IP 65

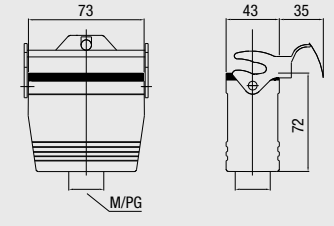
Bezeichnung Description	Metr.	PG	Bestelltext Designation	Bestell-Nr. Order No.
Sockelgehäuse: Kabeleingang seitlich, Standard Bauform <i>Surface mounted housing: Side entry, Standard construction</i>  	M25 2xM25	16 2x16	HB.10.SGD-LB.1.16.Z HB.10.SGD-LB.2.16.Z HB.10.SGD-LB.1.M25.Z HB.10.SGD-LB.2.M25.Z Mit Korrosionsschutz <i>With corrosion protection</i>	1-1102286-2 1-1102288-2 0-1103059-3 0-1106429-2
Sockelgehäuse: Kabeleingang seitlich, Hohe Bauform <i>Surface mounted housing: Side entry, High construction</i>  	2xM32	16 2x16	HB-K.10.SGD-LB.1.16.Z HB-K.10.SGD-LB.2.16.Z HB-K.10.SGD-LB.2.M25.Z Mit Korrosionsschutz <i>With corrosion protection</i>	2-1102286-2 2-1102288-2 0-1106429-6
Sockelgehäuse: Kabeleingang seitlich, Hohe Bauform <i>Surface mounted housing: Side entry, High construction</i>  	2xM32	2x21 29 2x29	HD.24.SGD-LB.2.21.Z HD.24.SGD-LB.1.29.Z HD.24.SGD-LB.2.29.Z HD.24.SGD-LB.2.M32.Z Mit Korrosionsschutz <i>With corrosion protection</i>	1-1102523-2 1-1102525-2 1-1102527-2 0-1106433-2
Kupplungsgehäuse: Kabeleingang unten, Standard Bauform <i>Cable-to-cable hood: Bottom entry, Standard construction</i>  	M25	21 2x29	HD-K.24.SGD-LB.1.21.Z HD-K.24.SGD-LB.1.29.Z HD-K.24.SGD-LB.2.29.Z HD-K.24.SGD-LB.2.M32.Z Mit Korrosionsschutz <i>With corrosion protection</i>	2-1102521-2 2-1102525-2 2-1102527-2 0-1106433-6
Kupplungsgehäuse: Kabeleingang unten, Hohe Bauform <i>Cable-to-cable hood: Bottom entry, High construction</i>  	M25	16 21	HB.10.KDO-LB.1.16.G HB.10.KDO-LB.1.21.G HB.10.KDO-LB.1.M25.G	1-1102279-2 1-1102282-2 0-1106428-1
Kupplungsgehäuse: Kabeleingang unten, Hohe Bauform <i>Cable-to-cable hood: Bottom entry, High construction</i>  	M32	29	HD.24.KDO-LB.1.29.G HD.24.KDO-LB.1.M32.G Mit Korrosionsschutz <i>With corrosion protection</i>	1-1102519-2 0-1106432-1
Kupplungsgehäuse: Kabeleingang unten, Hohe Bauform <i>Cable-to-cable hood: Bottom entry, High construction</i>  	M32	29	HD-K.24.KDO-LB.1.29.G HD-K.24.KDO-LB.1.M32.G Mit Korrosionsschutz <i>With corrosion protection</i>	2-1102519-2 0-1106432-3

Passende Kabelverschraubungen ab Seite 188/Suitable Cable fittings from page 188

HM.10 Gehäuse/Housings

Baugröße/Size 4

Pulverbeschichtet, silbergrau
 K = korrosionsgeschützt, schwarz

Powder-coated, silver-grey
K = corrosion-resistant, black

HM-10 Motoranschlußgehäuse/Motor connector

IP 65

Bezeichnung Description	A	B	Bestelltext Designation	Bestell-Nr. Order No.
HM-10 Motoranschlußgehäuse, Längsbügel am Gehäuse HM-10 Motor Connector, Side clip at housing				
	68,00	82,00	HM.10-82/82	8-1108772-2
	73,00	85,00	HM.10-85/85	8-1108772-5
	78,00	90,00	HM.10-90/90	8-1108772-0
	80,00	94,00	HM.10-94/94	8-1108772-4
	-	98,00	HM.10-98/98	8-1108772-8

HB-Z.10, HB-K/Z.10, HD-Z.24, HD-K/Z.24 Gehäuse/Housings







Baugröße/Size 4

Pulverbeschichtet, silbergrau
 K = korrosionsgeschützt, schwarz

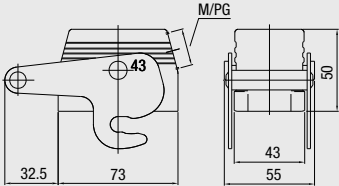
Powder-coated, silver-grey
K = corrosion-resistant, black

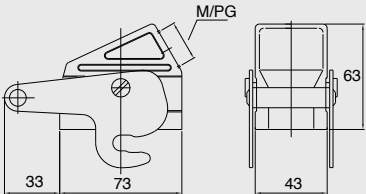
Zentralbügel am Steckergehäuse/Central locking clip on hood

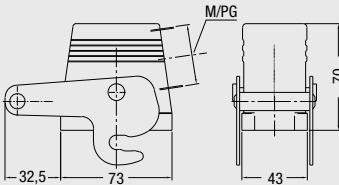
IP 65

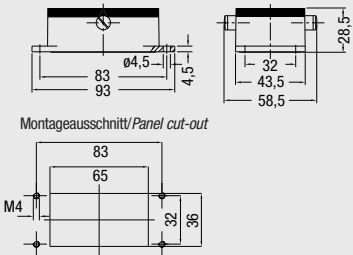
Bezeichnung Description	Metr.	PG	Bestelltext Designation	Bestell-Nr. Order No.
Steckergehäuse: Kabeleingang seitlich, Standard Bauform Hood: Side entry, Standard construction  	M25	16	HB-Z.10.STS-ZB.1.16.G HB-Z.10.STS-ZB.1.M25.G Mit Korrosionsschutz <i>With corrosion protection</i>	1-1102261-3 1-1106430-6
Steckergehäuse: Kabeleingang seitlich, Keilform Hood: Side entry, Standard construction  	M25	16	HB-KF.10.STS-ZB.1.16.G HB-KF.10.STS-ZB.1.M25.G Mit Korrosionsschutz <i>With corrosion protection</i>	1-1102211-3 0-1106431-4
Steckergehäuse: Kabeleingang seitlich, Hohe Bauform Hood: Side entry, High construction  	M32	21 29	HD-Z.24.STS-ZB.1.21.G HD-Z.24.STS-ZB.1.29.G HD-Z.24.STS-ZB.1.M32.G Mit Korrosionsschutz <i>With corrosion protection</i>	1-1102496-3 1-1102499-3 1-1106434-3
Anbaugehäuse: Kabeleingang unten, Standard Bauform Surface mounted housing: Bottom entry, Standard construction  			HB-Z.10.AG-ZVGR Mit Korrosionsschutz <i>With corrosion protection</i>	1-1102271-8 HB-K/Z.10.AG-ZVGR 2-1102271-8

Passende Kabelverschraubungen ab Seite 188/Suitable Cable fittings from page 188

HB-Z.10, HB-K/Z.10, HD-Z.24, HD-K/Z.24 Gehäuse/Housings







Baugröße/Size 4

Pulverbeschichtet, silbergrau
 K = korrosionsgeschützt, schwarz

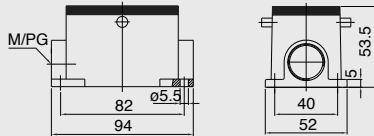
Powder-coated, silver-grey
K = corrosion-resistant, black

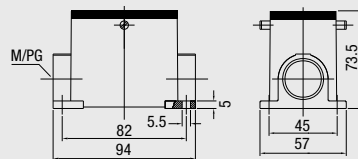
Zentralbügel am Steckergehäuse/Central locking clip on hood

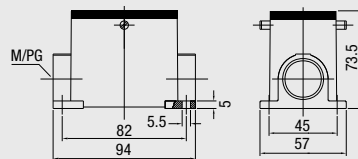
IP 65

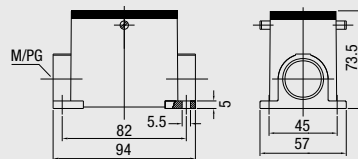
Bezeichnung Description	Metr.	PG	Bestelltext Designation	Bestell-Nr. Order No.	
<p>Sockelgehäuse: Kabeleingang seitlich, Standard Bauform <i>Surface mounted housing: Side entry, Standard construction</i></p>  	2xM25	16 2x16	HB-Z.10.SG-ZVGR.1.16.Z HB-Z.10.SG-ZVGR.2.16.Z HB-Z.10.SG-ZVGR.2.M25.Z Mit Korrosionsschutz <i>With corrosion protection</i>	1-1102274-8 1-1102276-8 1-1106429-0	
<p>Sockelgehäuse: Kabeleingang seitlich, Hohe Bauform <i>Surface mounted housing: Side entry, High construction</i></p>  		2xM32	16 2x16	HB-K/Z.10.SG-ZVGR.1.16.Z HB-K/Z.10.SG-ZVGR.2.16.Z HB-K/Z.10.SG-ZVGR.2.M25.Z	2-1102274-8 2-1102276-8 0-1106429-9
<p>Sockelgehäuse: Kabeleingang seitlich, Hohe Bauform <i>Surface mounted housing: Side entry, High construction</i></p>  			29 2x29	HD-Z.24.SG-ZVGR.1.29.Z HD-Z.24.SG-ZVGR.2.29.Z HD-Z.24.SG-ZVGR.2.M32.Z Mit Korrosionsschutz <i>With corrosion protection</i>	1-1102511-8 1-1102513-8 1-1106434-4
<p>Sockelgehäuse: Kabeleingang seitlich, Hohe Bauform <i>Surface mounted housing: Side entry, High construction</i></p>  	29 2x29		HD-K/Z.24.SG-ZVGR.1.29.Z HD-K/Z.24.SG-ZVGR.2.29.Z HD-K/Z.24.SG-ZVGR.2.M32.Z	2-1102511-8 2-1102513-8 0-1106469-9	

Passende Kabelverschraubungen ab Seite 188/Suitable Cable fittings from page 188

HIP.10/24, HIP-K.10/24, EMV-K.10/24 Gehäuse/Housings

Baugröße/Size 4

HIP: Druckdicht, silbergrau, **HIP-K:** Korrosionsgeschützt, schwarz





EMV-K: Schutz gegen elektromagnetische Beeinflussung, druckdicht, korrosionsgeschützt, schwarz

HIP: Pressure-tight, silver-grey, **HIP-K:** Housings corrosion-resistant, black

EMV-K: Protection against electro-magnetic interference, pressure-tight, housings corrosion-resistant, black

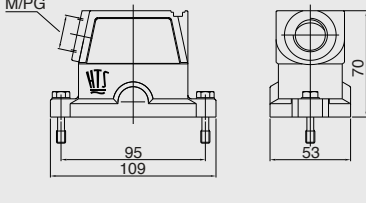
Druckdicht bis ≤ 5 bar/pressure-tight up to 5 bar

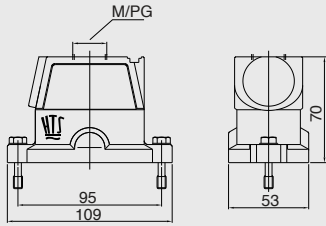
IP 68

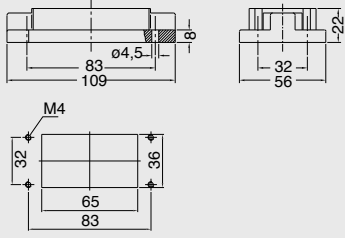
Bezeichnung Description	Metr.	PG	Bestelltext Designation	Bestell-Nr. Order No.
Steckergehäuse: Kabeleingang seitlich Hood: Side entry, Standard construction  	M25	16	HIP HIP.10/24.STS.1.16.G	1-1102640-5
		21	HIP.10/24.STS.1.21.G	1-1102642-5
			HIP.10/24.STS.1.M25.G	0-1106436-2
	M25 M32	21	HIP-K HIP-K.10/24.STS.1.21.G	2-1102642-5
			HIP-K.10/24.STS.1.M25.G	0-1106436-4
			HIP-K.10/24.STS.1.M32.G	0-1106436-6
	M25 M32	21	EMV-K EMV-K.10/24.STS.1.21.G	4-1102714-5
			EMV-K.10/24.STS.1.M25.G	0-1106427-3
			EMV-K.10/24.STS.1.M32.G	1-1106427-0
Steckergehäuse: Kabeleingang oben Hood: Top entry  	M25	16	HIP HIP.10/24.STO.1.16.G	1-1102644-5
		21	HIP.10/24.STO.1.21.G	1-1102646-5
			HIP.10/24.STO.1.M25.G	0-1106436-1
	M25 M32	16	HIP-K HIP-K.10/24.STO.1.16.G	2-1102644-5
			HIP-K.10/24.STO.1.M25.G	0-1106436-3
			HIP-K.10/24.STO.1.M32.G	0-1106436-5
	M25	21	EMV-K EMV-K.10/24.STO.1.21.G	4-1102715-5
			EMV-K.10/24.STO.1.M25.G	0-1106427-4
	Anbaugehäuse: Kabeleingang unten Surface mounted housing: Bottom entry   <p>Montageausschnitt/Panel cut-out</p>			HIP HIP.10/24.AG
			HIP-K HIP-K.10/24.AG	2-1102647-5
			EMV-K EMV-K.10/24.AG	4-1102718-5

Passende Kabelverschraubungen ab Seite 188/Suitable Cable fittings from page 188

HIP.10/24, HIP-K.10/24, EMV-K.10/24 Gehäuse/Housings

Baugröße/Size 4

HIP: Druckdicht, silbergrau, **HIP-K:** Korrosionsgeschützt, schwarz





EMV-K: Schutz gegen elektromagnetische Beeinflussung, druckdicht, korrosionsgeschützt, schwarz

HIP: Pressure-tight, silver-grey, **HIP-K:** Housings corrosion-resistant, black

EMV-K: Protection against electro-magnetic interference, pressure-tight, housings corrosion-resistant, black

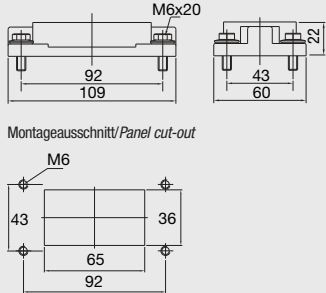
Druckdicht bis ≤ 5 bar/pressure-tight up to 5 bar

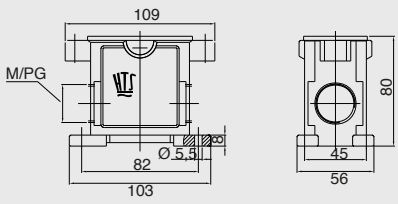
IP 68

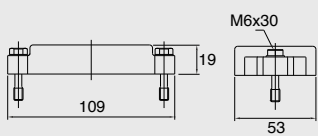
Bezeichnung Description	Metr.	PG	Bestelltext Designation	Bestell-Nr. Order No.
<p>Anbaugehäuse: Kabeleingang unten <i>Surface mounted housing: Bottom entry</i></p>   <p>Montageausschnitt/ Panel cut-out</p>			<p>HIP HIP.10/24.AG.M6</p> <p>HIP-K HIP-K.10.AG.M6</p> <p>EMV-K EMV-K.10/24.AG.M6</p>	<p>1-1102612-5</p> <p>2-1102612-5</p> <p>4-1102720-5</p>
<p>Sockelgehäuse: Kabeleingang seitlich <i>Surface mounted housing: Side entry</i></p>  	2xM32	21 2x21	<p>HIP HIP.10/24.SG.1.21.G HIP.10/24.SG.2.21.G HIP.10/24.SG.2.M32.G</p> <p>HIP-K HIP-K.10/24.SG.1.21.G HIP-K.10/24.SG.2.21.G</p> <p>EMV-K EMV-K.10/24.SG.1.21.G EMV-K.10/24.SG.2.21.G EMV-K.10/24.SG.2.M32.G</p>	<p>1-1102610-5</p> <p>1-1102611-5</p> <p>0-1106435-1</p> <p>5-1102610-5</p> <p>2-1102611-5</p> <p>5-1102716-5</p> <p>4-1102717-5</p> <p>0-1106426-2</p>
<p>Schutzkappe für Gehäuse-Unterteile <i>Protective covers for hoods and housing</i></p>  			<p>HIP HIP/EMV.10/24.SKB</p> <p>HIP-K/EMV-K HIP-K/EMV-K.10/24.SKB</p>	<p>3-1106202-5</p> <p>4-1106202-5</p>

Passende Kabelverschraubungen ab Seite 188/Suitable Cable fittings from page 188

HA.16 Kontakteinsätze/Contact inserts

Baugröße/Size 5







Schraubanschluss, Federzug-Anschluss,
Crimpschluss für gedrehte HE/HA Crimpkontakte

**Kontaktzahlen
No. of contacts**

*Screw terminal, Spring Clamp terminal,
Crimp terminal for screw machined HE/HA crimp contacts*

16 +

250 V/16 A

Bezeichnung Description	Bestelltext Designation	Bestell-Nr./Order No.													
		Stifteinsatz Male insert	Buchseinsatz Female insert												
<p>Stifteinsatz/Male insert</p> <p>Schraubanschluss/Screw terminal</p> 	HA.16.Sti.S.B 1-16	1-1103416-1													
<p>Buchseinsatz/Female insert</p> 	HA.16.Bu.S.B 1-16		1-1103417-1												
<p>Federzug-Anschluss/Spring Clamp terminal</p> 	HA.16.Sti.SC.B 1-16	7-1103416-1													
<p>Buchseinsatz/Female insert</p> 	HA.16.Bu.SC.B 1-16		7-1103417-1												
<p>Crimpschluss/Crimp terminal</p> 	HA.16.Sti.C.B 1-16	2-1103416-3													
<p>Buchseinsatz/Female insert</p> 	HA.16.Bu.C.B 1-16		2-1103417-3												
<p>Maße/Dimensions</p> <table border="1"> <tr> <td></td> <td>A</td> <td>B</td> <td>C</td> <td>D</td> <td>E</td> </tr> <tr> <td>mm</td> <td>66</td> <td>73</td> <td>23</td> <td>31</td> <td>28</td> </tr> </table>		A	B	C	D	E	mm	66	73	23	31	28			
	A	B	C	D	E										
mm	66	73	23	31	28										

Passende Crimpkontakte siehe Seite 37, Passende Crimpwerkzeuge siehe Seite 37
Suitable Crimp contacts see page 37, Suitable Crimping tools see page 37

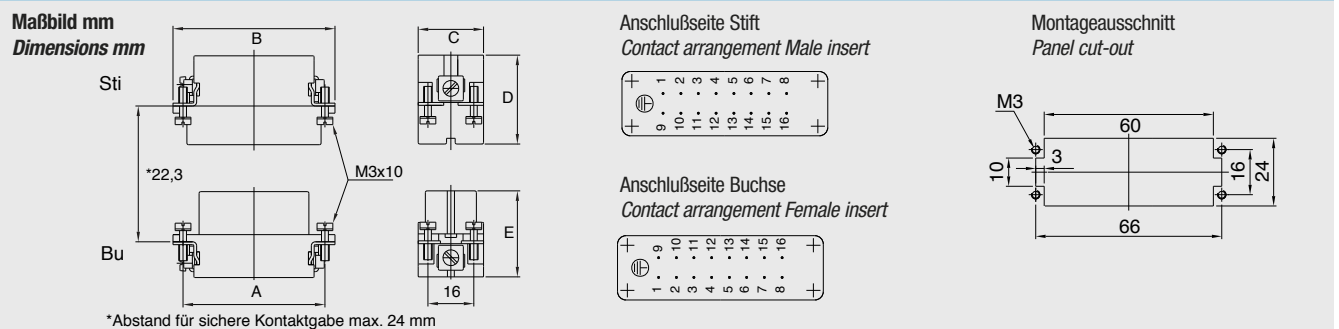

HN.D.25 Kontakteinsätze/Contact inserts

Baugröße/Size 5



Crimpanschluss für gedrehte HN.D Crimpkontakte

**Kontaktzahlen
No. of contacts**

Crimp terminal for screw machined HN.D crimp contacts

25 +

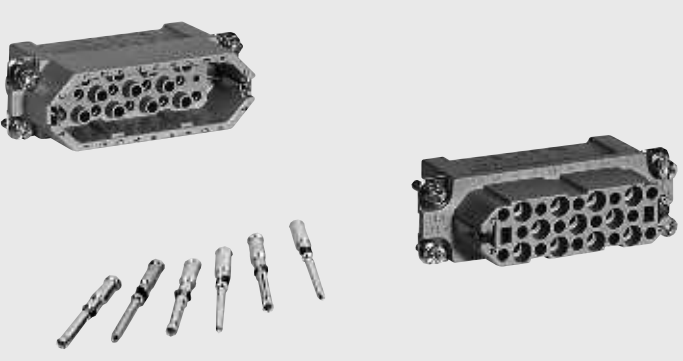
250 V/10 A

Bezeichnung Description	Bestelltext Designation	Bestell-Nr./Order No.	
		Stifteinsatz Male insert	Buchseinsatz Female insert
<p>Stifteinsatz/Male insert</p> <p>Crimpanschluss/Crimp terminal</p> 	<p>HN.D.25.Sti.C HN.D.25.Sti.C.B.1-25/Z</p>	<p>2-1103108-3 0-1103108-1</p>	
<p>Buchseinsatz/Female insert</p> 	<p>HN.D.25.Bu.C HN.D.25.Bu.C.B.1-25/Z</p>		<p>2-1103109-3 0-1103109-1</p>

*Zusätzliche Kennzeichnung „Z“ wie in Euromap 67 hinterlegt
*Marked with „Z“ according Euromap 67

Maße/Dimensions	A	B	C	D	E
mm	66	73	23	35	35

Passende Crimpkontakte siehe Seite 34, Passende Crimpwerkzeuge siehe Seite 34
Suitable Crimp contacts see page 34, Suitable Crimping tools see page 34

**Maßbild mm
Dimensions mm**

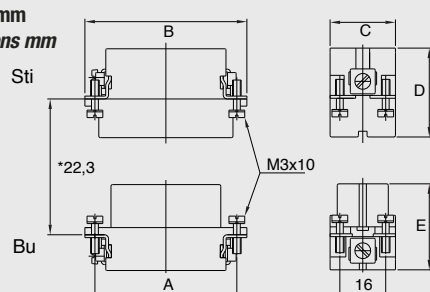

*Abstand für sichere Kontaktgabe max. 24 mm

**Anschlußseite Stift
Contact arrangement Male insert**

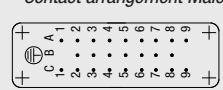

**Anschlußseite Buchse
Contact arrangement Female insert**

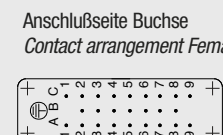

**Montageausschnitt
Panel cut-out**

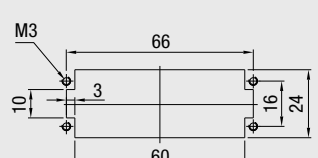

HD.25 Kontakteinsätze/Contact inserts

Baugröße/Size 5



Crimpanschluss für gestanzte HD.M Crimpkontakte

**Kontaktzahlen
No. of contacts**

Crimp terminal for stamped HD.M crimp contacts

25 +

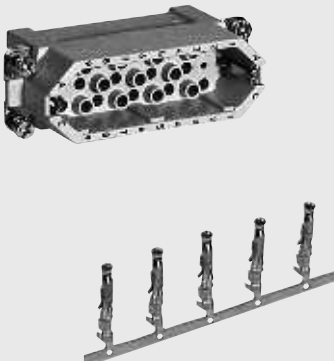
250 V/10 A

Bezeichnung Description	Bestelltext Designation	Bestell-Nr./Order No.	
		Stifteinsatz Male insert	Buchseinsatz Female insert
<p>Stifteinsatz/Male insert</p> <p>Crimpanschluss/Crimp terminal</p> 	HD.25.Sti.C	2-1103010-3	
<p>Buchseinsatz/Female insert</p> 	HD.25.Bu.C		2-1103011-3

Maße/Dimensions	A	B	C	D	E
mm	66	73	23	35	35

Passende Crimpkontakte siehe Seite 35, Passende Crimpwerkzeuge siehe Seite 35
 Suitable Crimp contacts see page 35, Suitable Crimping tools see page 35

Maßbild mm
Dimensions mm

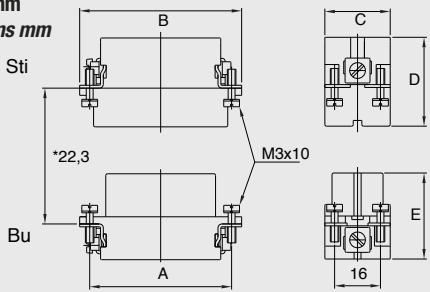

*Abstand für sichere Kontaktgabe max. 24 mm

Anschlußseite Stift
Contact arrangement Male insert

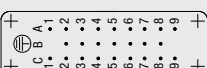

Anschlußseite Buchse
Contact arrangement Female insert

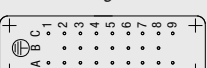

Montageausschnitt
Panel cut-out

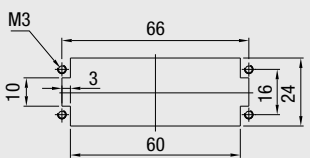

HA.16/HD.25 Gehäuse/Housings







Baugröße/Size 5

Pulverbeschichtet, silbergrau

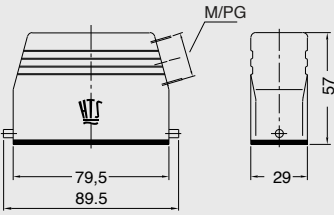
Powder-coated, silver-grey

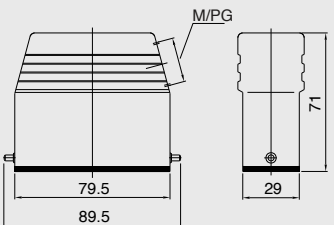
Längsbügel am Unterteil/Side clip at housing bottom

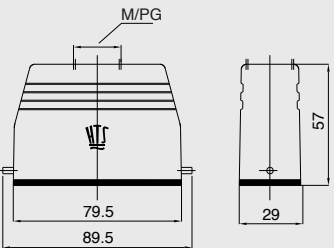
IP 65

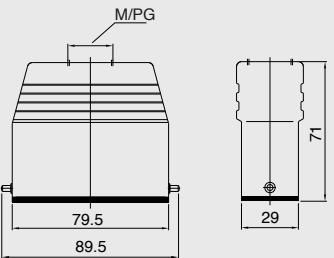
Bezeichnung Description	Metr.	PG	Bestelltext Designation	Bestell-Nr. Order No.
<p>Steckergehäuse: Kabeleingang seitlich <i>Hood:</i> Side entry</p>  	M20	16	HA.16.STS.1.16.G HA.16.STS.1.M20.G	1-1102136-7 0-1106439-2
<p>Steckergehäuse: Kabeleingang seitlich <i>Hood:</i> Side entry</p>  	M25	16 21	HD.25.STS.1.16.G HD.25.STS.1.21.G HD.25.STS.1.M25.G	1-1102530-7 1-1102533-7 0-1106442-2
<p>Steckergehäuse: Kabeleingang oben, <i>Hood:</i> Top entry</p>  	M20	16	HA.16.STO.1.16.G HA.16.STO.1.M20.G	1-1102139-7 0-1106439-1
<p>Steckergehäuse: Kabeleingang oben, <i>Hood:</i> Top entry</p>  	M25	16 21	HD.25.STO.1.16.G HD.25.STO.1.21.G HD.25.STO.1.M25.G	1-1102536-7 1-1102539-7 0-1106442-1

Passende Kabelverschraubungen ab Seite 188/Suitable Cable fittings from page 188

HA.16/HD.25 Gehäuse/Housings

Baugröße/Size 5

Pulverbeschichtet, silbergrau

Powder-coated, silver-grey

Längsbügel am Unterteil/Side clip at housing bottom

IP 65

Bezeichnung Description	Metr.	PG	Bestelltext Designation	Bestell-Nr. Order No.
<p>Anbaugehäuse: Kabeleingang unten <i>Surface mounted housing: Bottom entry</i></p> <p>Montageausschnitt/Panel cut-out</p>			HA.16.AG-LB	1-1102140-2
<p>Anbaugehäuse: Kabeleingang unten <i>Surface mounted housing: Bottom entry</i></p>			HA.16.AGD-LB	1-1102141-2
<p>Sockelgehäuse: Kabeleingang seitlich <i>Surface mounted housing: Side entry</i></p>	M20 2xM20	16 2x16	HA.16.SG-LB.1.16 Z HA.16.SG-LB.2.16 Z HA.16.SG-LB.1.M20.Z HA.16.SG-LB.2.M20.Z	1-1102143-2 1-1102145-2 0-1106438-2 0-1103058-1
<p>Sockelgehäuse: Kabeleingang seitlich, Hohe Bauform <i>Surface mounted housing: Side entry, High construction</i></p>	2xM25	16 2x16 21 2x21	HD.25.SG-LB.1.16 Z HD.25.SG-LB.2.16 Z HD.25.SG-LB.1.21 Z HD.25.SG-LB.2.21 Z HD.25.SG-LB.2.M25.Z	1-1102541-2 1-1102543-2 1-1102545-2 1-1102547-2 0-1106441-2

Passende Kabelverschraubungen ab Seite 188/Suitable Cable fittings from page 188

HA.16/HD.25 Gehäuse/Housings

Baugröße/Size 5

Pulverbeschichtet, silbergrau

Powder-coated, silver-grey

Längsbügel am Unterteil/Side clip at housing bottom

IP 65

Bezeichnung Description	Metr.	PG	Bestelltext Designation	Bestell-Nr. Order No.
<p>Sockelgehäuse: Kabeleingang seitlich, Standard Bauform <i>Surface mounted housing: Side entry, Standard construction</i></p>	M20 2xM20	16 2x16	HA.16.SGD-LB.1.16 Z HA.16.SGD-LB.2.16 Z HA.16.SGD-LB.1.M20.Z HA.16.SGD-LB.2.M20.Z	1-1102147-2 1-1102149-2 0-1106438-1 0-1103058-2
<p>Sockelgehäuse: Kabeleingang seitlich, Hohe Bauform <i>Surface mounted housing: Side entry, High construction</i></p>	2xM25	16 2x16 21 2x21	HD.25.SGD-LB.1.16 Z HD.25.SGD-LB.2.16 Z HD.25.SGD-LB.1.21 Z HD.25.SGD-LB.2.21.Z HD.25.SGD-LB.2.M25.Z	1-1102549-2 1-1102551-2 1-1102553-2 1-1102555-2 0-1106441-1
<p>Kupplungsgehäuse: Kabeleingang unten, Standard Bauform <i>Cable-to-cable hood: Bottom entry, Standard construction</i></p>	M20	16	HA.16.KDO-LB.1.16 G HA.16.KDO-LB.1.M20.G	1-1102152-2 0-1106437-1
<p>Kupplungsgehäuse: Kabeleingang unten, Hohe Bauform <i>Cable-to-cable hood: Bottom entry, High construction</i></p>	M25	21	HD.25.KDO-LB.1.21 G HD.25.KDO-LB.1.M25.G	1-1102561-2 0-1106440-1

Passende Kabelverschraubungen ab Seite 188/Suitable Cable fittings from page 188

HE.16 Kontakteinsätze/Contact inserts

Baugröße/Size 6







Schraubanschluss, Federzug-Anschluss,
Crimpanschluss für gedrehte HE/HA Crimpkontakte

**Kontaktzahlen
No. of contacts**

*Screw terminal, Spring Clamp terminal,
Crimp terminal for screw machined HE/HA crimp contacts*

16 +

400 V/16 A

Bezeichnung Description	Bestelltext Designation	Bestell-Nr./Order No.													
		Stifteinsatz Male insert	Buchseinsatz Female insert												
<p>Stifteinsatz/Male insert</p> <p>Schraubanschluss/Screw terminal</p> 	HE.16.Sti.S.B 1-16	1-1103638-1													
<p>Buchseinsatz/Female insert</p> 	HE.16.Bu.S.B 1-16		1-1103639-1												
<p>Federzug-Anschluss/Spring Clamp terminal</p> 	HE.16.Sti.SC.B 1-16	7-1103638-1													
<p>Buchseinsatz/Female insert</p> 	HE.16.Bu.SC.B 1-16		7-1103639-1												
<p>Crimpanschluss/Crimp terminal</p> 	HE.16.Sti.C.B 1-16	2-1103638-3													
<p>Buchseinsatz/Female insert</p> 	HE.16.Bu.C.B 1-16		2-1103639-3												
<p>Maße/Dimensions</p> <table border="1"> <tr> <td></td> <td>A</td> <td>B</td> <td>C</td> <td>D</td> <td>E</td> </tr> <tr> <td>mm</td> <td>77,5</td> <td>83,5</td> <td>33</td> <td>34</td> <td>35</td> </tr> </table>		A	B	C	D	E	mm	77,5	83,5	33	34	35			
	A	B	C	D	E										
mm	77,5	83,5	33	34	35										

Passende Crimpkontakte siehe Seite 37, Passende Crimpwerkzeuge siehe Seite 37
Suitable Crimp contacts see page 37, Suitable Crimping tools see page 37

**Maßbild mm
Dimensions mm**

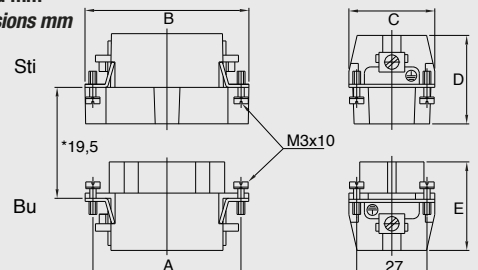

*Abstand für sichere Kontaktgabe max. 21 mm

**Anschlußseite Stift
Contact arrangement Male insert**

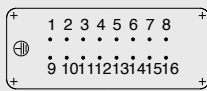

**Anschlußseite Buchse
Contact arrangement Female insert**

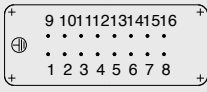

**Montageausschnitt
Panel cut-out**

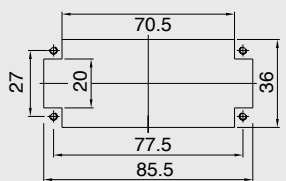

HEE.32 Kontakteinsätze/Contact inserts

Baugröße/Size 6



Crimpanschluss für gedrehte HE Crimpkontakte

**Kontaktzahlen
No. of contacts**

Crimp terminal for screw machined HE crimp contacts

32 +

500 V/16 A

Bezeichnung Description	Bestelltext Designation	Bestell-Nr./Order No.	
		Stifteinsatz Male insert	Buchseinsatz Female insert
<p>Stifteinsatz/Male insert</p> <p>Crimpanschluss/Crimp terminal</p> 	<p>HEE.32.Sti.C HEE.32.Sti.C.FS*</p>	<p>0-1102895-1 0-1102895-3</p>	
<p>Buchseinsatz/Female insert</p> 	<p>HEE.32.Bu.C HEE.32.Bu.C.FS*</p>		<p>0-1102896-1 0-1102896-3</p>

*Kunststoff ist I2F1 qualifiziert nach NF-F 16-101, 102
Plastic is qualified I2F1 according NF-F 16-101, 102

Maße/Dimensions	A	B	C	D	E
mm	77,5	83,5	33	34	37

Passende Crimpkontakte siehe Seite 37, Passende Crimpwerkzeuge siehe Seite 37
Suitable Crimp contacts see page 37, Suitable Crimping tools see page 37

**Maßbild mm
Dimensions mm**

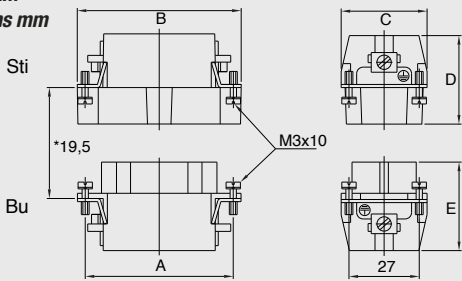

*Abstand für sichere Kontaktgabe max. 21 mm

**Kontaktanordnung Anschlußseite Stift
Contact arrangement Male insert**

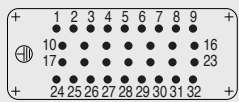

**Kontaktanordnung Anschlußseite Buchse
Contact arrangement Female insert**

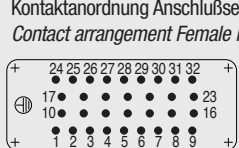

**Montageausschnitt
Panel cut-out**

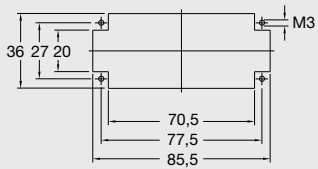

HVT.23 Kontakteinsätze/Contact inserts

Baugröße/Size 6



Crimpanschluss für gedrehte HVT Crimpkontakte

**Kontaktzahlen
No. of contacts**

Crimp terminal for screw machined HVT crimp contacts

23 +

400 V/16 A

Bezeichnung Description	Bestelltext Designation	Bestell-Nr./Order No.	
		Stifteinsatz Male insert	Buchseinsatz Female insert
<p>Stifteinsatz/Male insert</p> <p>Crimpanschluss/Crimp terminal</p> 	HVT.23.Sti.C	2-1104008-3	
<p>Buchseinsatz/Female insert</p> 	HVT.23.Bu.C		2-1104010-3

Maße/Dimensions	A	B	C	D	E
mm	77,5	83,5	33	35	40

Passende Crimpkontakte siehe Seite 38, Passende Crimpwerkzeuge siehe Seite 38
 Suitable Crimp contacts see page 38, Suitable Crimping tools see page 38

Maßbild mm
Dimensions mm

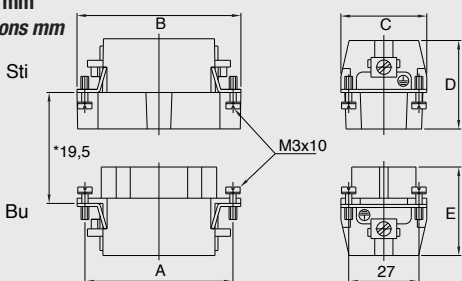

*Abstand für sichere Kontaktgabe max. 21 mm

Anschlußseite Stift
Contact arrangement Male insert

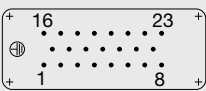

Anschlußseite Buchse
Contact arrangement Female insert

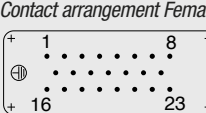

Montageausschnitt
Panel cut-out

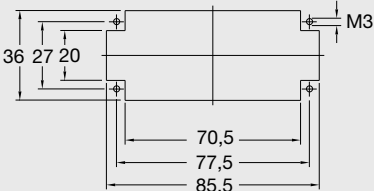

HN.D.40/HN.2D.72 Kontakteinsätze/Contact inserts

Baugröße/Size 6

Crimpanschluss für gedrehte HN.D Crimpkontakte

Kontaktzahlen

No. of contacts

Crimp terminal for screw machined HN.D crimp contacts

40/72 +

250 V/10 A

Bezeichnung Description	Bestelltext Designation	Bestell-Nr./Order No.	
		Stifteinsatz Male insert	Buchseinsatz Female insert
<p>Stifteinsatz/Male insert</p> <p>Crimpanschluss/Crimp terminal</p>	HN.D.40.Sti.C	2-1103110-3	
<p>Buchseinsatz/Female insert</p>	HN.D.40.Bu.C		2-1103111-3
<p>Crimpanschluss/Crimp terminal</p>	HN.2D.72.Sti.C.B1-72	2-1103208-3	
	HN.2D.72.Bu.C.B1-72		2-1103212-3

HN.D.40					
Maße/Dimensions	A	B	C	D	E
mm	77,5	84,5	33	35	35

HN.2D.72					
Maße/Dimensions	A	B	C	D	E
mm	77,5	83,5	34	36,5	37

Passende Crimpkontakte siehe Seite 34, Passende Crimpwerkzeuge siehe Seite 34
 Suitable Crimp contacts see page 34, Suitable Crimping tools see page 34

Maßbild mm/Dimensions mm

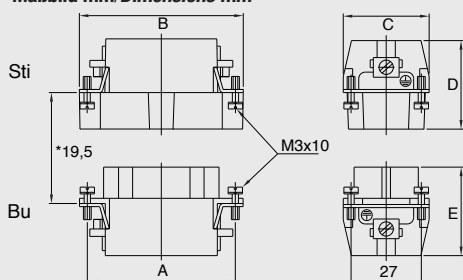

Anschlußseite Stift/Contact arrangement Male insert
 HN.D.40 HN.2D.72

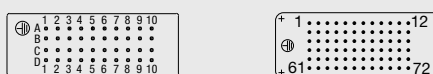

Anschlußseite Buchse/Contact arrangement Female insert
 HN.D.40 HN.2D.72



Montageausschnitt
 Panel cut-out

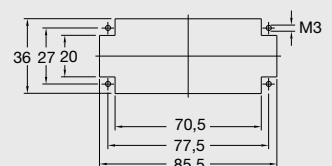

*Abstand für sichere Kontaktgabe max. 21 mm

HD.40 Kontakteinsätze/Contact inserts

Baugröße/Size 6



Crimpanschluss für gestanzte HD.M Crimpkontakte

**Kontaktzahlen
No. of contacts**

Crimp terminal for stamped HD.M crimp contacts

40 +

250 V/10 A

Bezeichnung Description	Bestelltext Designation	Bestell-Nr./Order No.	
		Stifteinsatz Male insert	Buchseinsatz Female insert
<p>Stifteinsatz/Male insert</p> <p>Crimpanschluss/Crimp terminal</p> 	HD.40.Sti.C	2-1103012-3	
<p>Buchseinsatz/Female insert</p> 	HD.40.Bu.C		2-1103013-3

Maße/Dimensions	A	B	C	D	E
mm	77,5	84,5	33	35	35

Passende Crimpkontakte siehe Seite 35, Passende Crimpwerkzeuge siehe Seite 35
 Suitable Crimp contacts see page 35, Suitable Crimping tools see page 35

**Maßbild mm
Dimensions mm**

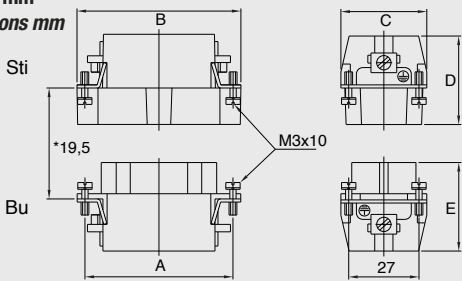

**Anschlußseite Stift
Contact arrangement Male insert**

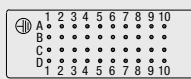

**Anschlußseite Buchse
Contact arrangement Female insert**

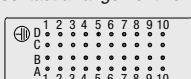

**Montageausschnitt
Panel cut-out**

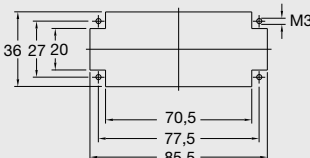

HSK.6+36 Kontakteinsätze/Contact inserts

Baugröße/Size 6



Crimpanschluss für gedrehte HSK/HN.D Crimpkontakte

**Kontaktzahlen
No. of contacts**

Crimp terminal for screw machined HSK/HN.D crimp contacts

6 + 36 +

690 V/40 A, 250 V/10 A

Bezeichnung Description	Bestelltext Designation	Bestell-Nr./Order No.	
		Stifteinsatz Male insert	Buchseinsatz Female insert
<p>Stifteinsatz/Male insert</p> <p>Crimpanschluss/Crimp terminal</p> 	HSK.6/36.Sti.C	0-1108761-1	
<p>Buchseinsatz/Female insert</p> 	HSK.6/36.Bu.C		0-1108762-1

Maße/Dimensions	A	B	C	D	E
mm	77,5	83,5	34	39	41

Passende Crimpkontakte Power siehe Seite 39, passende Crimpkontakte Signal siehe Seite 34
 Suitable Crimp contacts Power see page 39, suitable Crimp contacts Signal see page 34

Maßbild mm
Dimensions mm

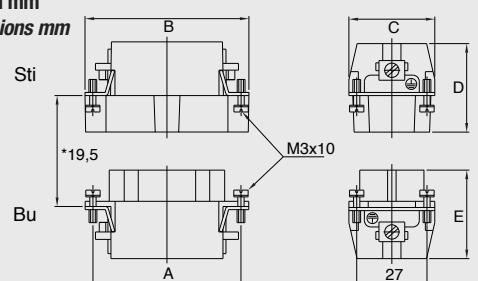

*Abstand für sichere Kontaktgabe max. 21 mm

Anschlußseite Stift
Contact arrangement Male insert

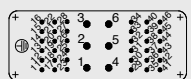

Anschlußseite Buchse
Contact arrangement Female insert

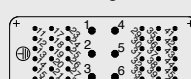

Montageausschnitt
Panel cut-out

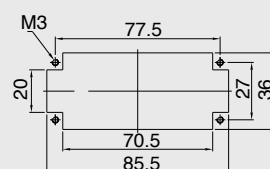

HMX.6/12 + 12/2 Kontakteinsätze/Contact inserts

Baugröße/Size 6

Crimpschluss für gedrehte HSK/HN.D Crimpkontakte

Kontaktzahlen

No. of contacts

Crimp terminal for screw machined HSK/HN.D crimp contacts

6/12; 12/2 +

690 V/40 A, 400 V/10 A; 500 V/40 A, 250 V/10 A

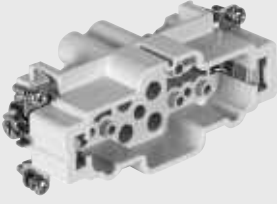
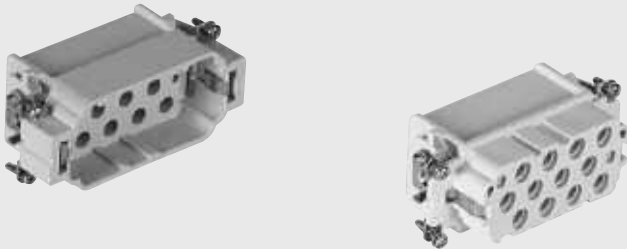
Bezeichnung Description	Bestelltext Designation	Bestell-Nr./Order No.	
		Stifteinsatz Male insert	Buchseinsatz Female insert
Stifteinsatz/Male insert Buchseinsatz/Female insert Crimpschluss/Crimp terminal 	HMX.6/12.Sti.C HMX.6/12.Bu.C	0-1103146-1 0-1103147-1	
	HMX.12/2.Sti.C HMX.12/2.Bu.C	0-1103153-1 0-1103154-1	

HMX.6/12

Maße/Dimensions	A	B	C	D	E
mm	77,5	84	35	39	38

HMX.12/2

Maße/Dimensions	A	B	C	D	E
mm	77,5	84	34	39	38

Passende Crimpkontakte Power siehe Seite 39, passende Crimpkontakte Signal siehe Seite 34
Suitable Crimp contacts Power see page 39, suitable Crimp contacts Signal see page 34

Maßbild mm/Dimensions mm

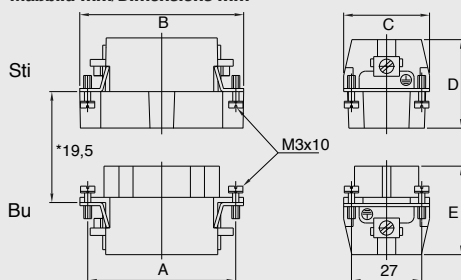

*Abstand für sichere Kontaktgabe max. 21 mm

**Anschlußseite Stift
Contact arrangement Male insert**

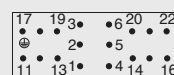

**Anschlußseite Buchse
Contact arrangement Female insert**

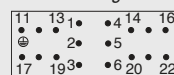

**Montageausschnitt
Panel cut-out**

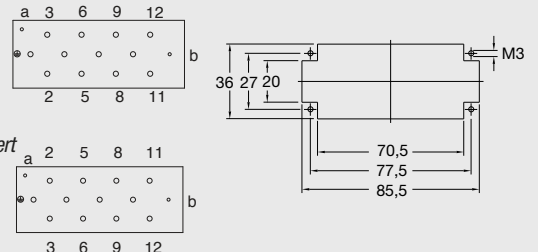

HSB.6/35; HMX4/2; HMX4/0 Kontakteinsätze/Contact inserts

Baugröße/Size 6

Schraubanschluss

Kontaktzahlen

Screw terminal

No. of contacts

6; 4/2; 4/0 +

400 V/35 A; 690 V/80 A, 400 V/16 A; 690 V/80 A

Bezeichnung Description		Bestelltext Designation	Bestell-Nr./Order No.	
			Stifteinsatz Male insert	Buchseinsatz Female insert
Stifteinsatz/Male insert	Buchseinsatz/Female insert			
Schraubanschluss/Screw terminal				
		HSB.6.35.Sti.S.B 1-6	1-1104204-1	
		HSB.6.35.Bu.S.B 1-6		1-1104205-1
Schraubanschluss/Screw terminal				
		HMX.4/2.Sti.S HMX.4/0.Sti.S	0-1102075-1 0-1104701-1	
		HMX.4/2.Bu.S HMX.4/0.Bu.S		0-1102076-1 0-1104700-1

HSB.6/35					
Maße/Dimensions	A	B	C	D	E
mm	77,5	83,5	33	33	33,5

HMX.4/2; HMX.4/0					
Maße/Dimensions	A	B	C	D	E
mm	77,5	83	33	45	46

Maßbild mm/Dimensions mm

**Anschlußseite Stift
Contact arrangement Male insert**

**Montageausschnitt
Panel cut-out**

**Anschlußseite Buchse
Contact arrangement Female insert**

*Abstand für sichere Kontaktgabe max. 21 mm

Modul Halterahmen/Module Fixing Frame

Baugröße/Size 6

**Bezeichnung
Description**

Halterahmen/Fixing frame



Für Modul MDL Seite 194–203
For module MDL page 194–203

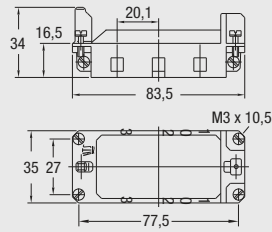

MDL2-GR.0-6/B.1-3

0-1108782-1

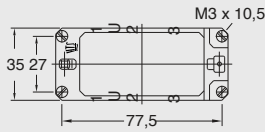

MDL2-GR.U-6/B.1-3

0-1108782-2

Montageausschnitt/Panel cut-out

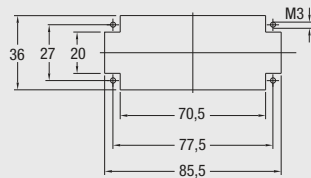

Halterahmen/Fixing frame

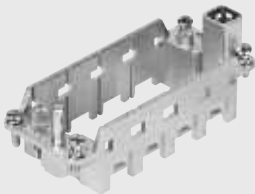

Für Modul HVS Seite 204–212
For module HVS page 204–212

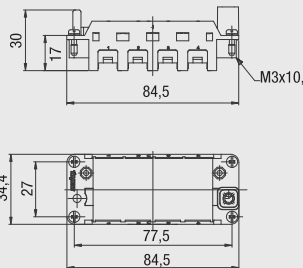

HVS-R.0 1-4
HVS-R.u 1-4

0-1103250-3

0-1103250-4

Montageausschnitt/Panel cut-out

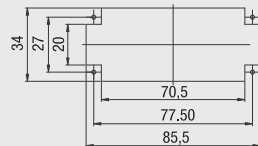

HB.16, HB-K.16, HD.40, HD-K.40 Gehäuse/Housings





Baugröße/Size 6

Pulverbeschichtet, silbergrau
K = korrosionsgeschützt, schwarz

Powder-coated, silver-grey
K = corrosion-resistant, black

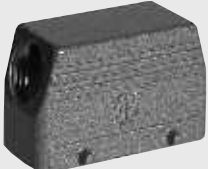
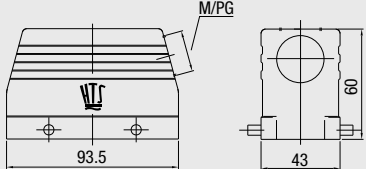
Verschlussbügel am Unterteil/Locking clip at housing bottom

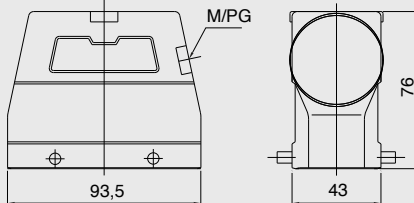
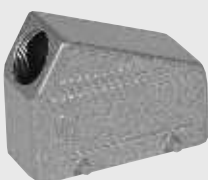
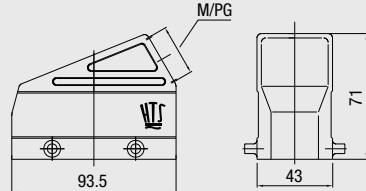
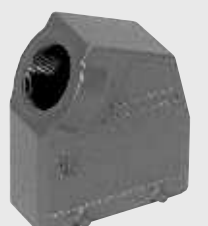
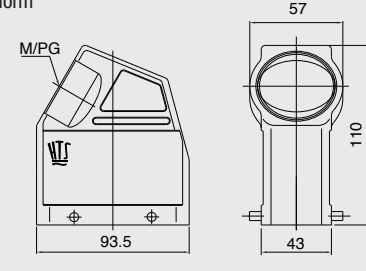
IP 65

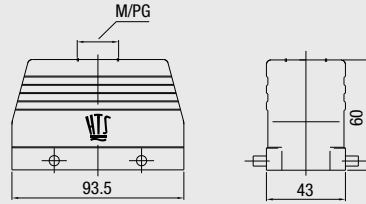
Bezeichnung Description	Metr.	PG	Bestelltext Designation	Bestell-Nr. Order No.
Steckergehäuse: Kabeleingang seitlich, Standard Bauform Hood: Side entry, Standard construction  	M25 M32	21	HB.16.STS.1.21.G HB.16.STS.1M25.G HB.16.STS.1M32.G Mit Korrosionsschutz With corrosion protection	1-1102292-6 2-1106449-5 0-1106449-4
Steckergehäuse: Kabeleingang seitlich, Hohe Bauform Hood: Side entry, High construction  	M32 M40	21 29	HD.40.STS.1.21.G HD.40.STS.1.29.G HD.40.STS.1.M32.G HD.40.STS.1.M40.G Mit Korrosionsschutz With corrosion protection	1-1102564-6 1-1102567-6 0-1106452-4 1-1106452-7
Steckergehäuse: Kabeleingang seitlich, Keilform Hood: Side entry, Standard construction  	M32	21	HB-KF.16.STS.1.21.G HB-KF.16.STS.1.M32.G Mit Korrosionsschutz With corrosion protection	1-1102220-6 1-1106449-5
Steckergehäuse: Kabeleingang seitlich, Keilform Hood: Side entry, Standard construction  	M40	29	HD-KF.40.STS.1.29.G HD-KF.40.STS.1.M40.G Mit Korrosionsschutz With corrosion protection	1-1102765-0 1-1102766-0
Steckergehäuse: Kabeleingang oben, Standard Bauform Hood: Top entry, Standard construction  	M32	21	HB.16.STO.1.21.G HB.16.STO.1M32.G Mit Korrosionsschutz With corrosion protection	1-1102295-6 0-1106449-1
	M32	21	HB-K.16.STO.1.21.G HB-K.16.STO.1M32.G	2-1102295-6 0-1106449-7

Passende Kabelverschraubungen ab Seite 188/Suitable Cable fittings from page 188

HB.16, HB-K.16, HD.40, HD-K.40 Gehäuse/Housings







Baugröße/Size 6

Pulverbeschichtet, silbergrau
 K = korrosionsgeschützt, schwarz

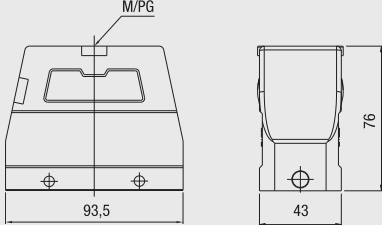
Powder-coated, silver-grey
K = corrosion-resistant, black

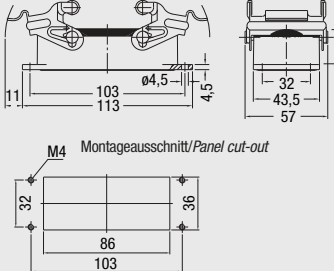
Verschlussbügel am Unterteil/Locking clip at housing bottom

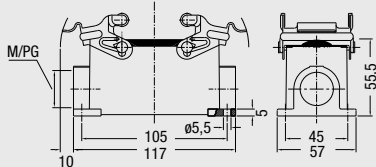
IP 65

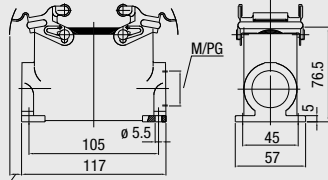
Bezeichnung Description	Metr.	PG	Bestelltext Designation	Bestell-Nr. Order No.
Steckergehäuse: Kabeleingang oben, Hohe Bauform <i>Hood: Top entry, High construction</i>  	M32 M40	2x21 21 29	HD.40.STO.2.21.G HD.40.STO.1.21.G HD.40.STO.1.29.G HD.40.STO.1.M32.G HD.40.STO.1.M40.G Mit Korrosionsschutz With corrosion protection	3-1102570-0 1-1102570-6 1-1102573-6 0-1106452-1 0-1102920-1
Anbaugehäuse: Kabeleingang unten, Standard Bauform <i>Surface mounted housing: Bottom entry, Standard construction</i>  	M32	21 29	HD-K.40.STO.1.21.G HD-K.40.STO.1.29.G HD-K.40.STO.1.M32.G HB.16.AG-VS Mit Korrosionsschutz With corrosion protection HB-K.16.AG-VS	2-1102570-6 2-1102573-6 0-1106452-7 1-1102296-1 2-1102296-1
Sockelgehäuse: Kabeleingang seitlich, Standard Bauform <i>Surface mounted housing: Side entry, Standard construction</i>  	M25 2xM25	21 2x21	HB.16.SG-VS.1.21.Z HB.16.SG-VS.2.21.Z HB.16.SG-VS.1.M25.Z HB.16.SG-VS.2.M25.Z Mit Korrosionsschutz With corrosion protection	1-1102299-1 1-1102301-1 0-1103060-1 0-1106448-4
Sockelgehäuse: Kabeleingang seitlich, Hohe Bauform <i>Surface mounted housing: Side entry, High construction</i>  	M32 2xM32	21 2x21 29 2x29	HD.40.SG-VS.1.21.Z HD.40.SG-VS.2.21.Z HD.40.SG-VS.1.29.Z HD.40.SG-VS.2.29.Z HD.40.SG-VS.1.M32.Z HD.40.SG-VS.2.M32.Z Mit Korrosionsschutz With corrosion protection	1-1102575-1 1-1102577-1 1-1102579-1 1-1102581-1 0-1103082-1 0-1106451-4
	2xM32	21 2x21 29	HD-K.40.SG-VS.1.21.Z HD-K.40.SG-VS.2.21.Z HD-K.40.SG-VS.1.29.Z HD-K.40.SG-VS.2.M32.Z	2-1102575-1 2-1102577-1 2-1102579-1 0-1106451-8

Passende Kabelverschraubungen ab Seite 188/Suitable Cable fittings from page 188

HB.16, HB-K.16, HD.40, HD-K.40 Gehäuse/Housings

Baugröße/Size 6

Pulverbeschichtet, silbergrau
 K = korrosionsgeschützt, schwarz

Powder-coated, silver-grey
K = corrosion-resistant, black

Verschlussbügel am Unterteil/Locking clip at housing bottom

IP 65

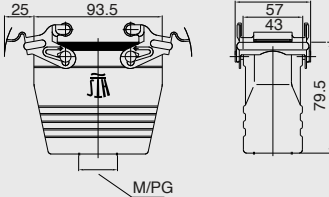
Bezeichnung Description	Metr.	PG	Bestelltext Designation	Bestell-Nr. Order No.
<p>Kupplungsgehäuse: Kabeleingang unten, Hohe Bauform <i>Cable-to-cable hood:</i> Bottom entry, High construction</p>  			<p>HD.40.KDO-VS.1.21.G HD.40.KDO-VS.1.29 G HD.40.KDO-VS.1.M32.G</p> <p>Mit Korrosionsschutz <i>With corrosion protection</i></p> <p>HD-K.40.KDO-VS.1.29 G HD-K.40.KDO-VS.1.M32.G</p>	<p>1-1102584-1 1-1102587-1 0-1106450-2</p> <p>2-1102587-1 0-1106450-4</p>

Passende Kabelverschraubungen ab Seite 188/Suitable Cable fittings from page 188

HB.16, HB-K.16, HD.40, HD-K.40 Gehäuse/Housings



Baugröße/Size 6

Pulverbeschichtet, silbergrau
 K = korrosionsgeschützt, schwarz

Powder-coated, silver-grey
K = corrosion-resistant, black

Verschlussbügel am Oberteil/Locking clip on hood

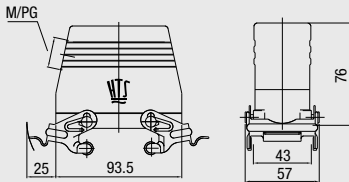
IP 65

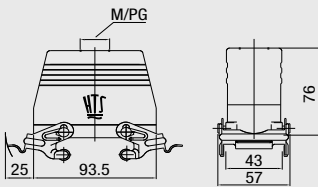
Bezeichnung Description	Metr.	PG	Bestelltext Designation	Bestell-Nr. Order No.
Steckergehäuse: Kabeleingang seitlich, Hohe Bauform Hood: Side entry, High construction  	M32	21	HD.40.STS-VS.1.21.G	1-1102564-1
		29	HD.40.STS-VS.1.29.G	1-1102567-1
			HD.40.STS-VS.1.M32.G	0-1106452-6
			Mit Korrosionsschutz With corrosion protection	
Steckergehäuse: Kabeleingang oben, Hohe Bauform Hood: Top entry, High construction  	M32	21	HD.40.STO-VS.1.21.G	1-1102570-1
		29	HD.40.STO-VS.1.29.G	1-1102573-1
			HD.40.STO-VS.1.M32.G	0-1106452-3
			Mit Korrosionsschutz With corrosion protection	
	M32	21	HD-K.40.STO-VS.1.21.G	2-1102570-1
			HD-K.40.STO-VS.1.M32.G	0-1106452-9

Passende Kabelverschraubungen ab Seite 188/Suitable Cable fittings from page 188

HB.16, HB-K.16, HD.40, HD-K.40 Gehäuse/Housings

Baugröße/Size 6

Pulverbeschichtet, silbergrau
 K = korrosionsgeschützt, schwarz

Powder-coated, silver-grey
K = corrosion-resistant, black

Verschlussbügel am Oberteil/Locking clip on hood

IP 65

Bezeichnung Description	Metr.	PG	Bestelltext Designation	Bestell-Nr. Order No.
<p>Anbaugehäuse: Kabeleingang unten, Standard Bauform <i>Surface mounted housing: Bottom entry, Standard construction</i></p>			HB.16.AGD Mit Korrosionsschutz <i>With corrosion protection</i> HB-K.16.AGD	1-1102305-6 2-1102305-6
<p>Sockelgehäuse: Kabeleingang seitlich, Standard Bauform <i>Surface mounted housing: Side entry, Standard construction</i></p>	M25 2xM25	21 2x21	HB.16.SGD.1.21.Z HB.16.SGD.2.21.Z HB.16.SGD.1.M25.Z HB.16.SGD.2.M25.Z Mit Korrosionsschutz <i>With corrosion protection</i>	1-1102308-6 1-1102310-6 0-1103060-2 0-1106448-1
<p>Sockelgehäuse: Kabeleingang seitlich, Hohe Bauform <i>Surface mounted housing: Side entry, High construction</i></p>	2xM32	21 2x21 29 2x29	HD.40.SGD.1.21.Z HD.40.SGD.2.21.Z HD.40.SGD.1.29.Z HD.40.SGD.2.29.Z HD.40.SGD.2.M32.Z Mit Korrosionsschutz <i>With corrosion protection</i>	1-1102589-6 1-1102591-6 1-1102593-6 1-1102595-6 0-1106451-1
	2xM32	21 2x21	HD-K.40.SGD.1.21.Z HD-K.40.SGD.2.21.Z HD-K.40.SGD.2.M32.Z	2-1102589-6 2-1102591-6 0-1106451-5

Passende Kabelverschraubungen ab Seite 188/Suitable Cable fittings from page 188

HB.16, HB-K.16, HD.40, HD-K.40 Gehäuse/Housings





Baugröße/Size 6

Pulverbeschichtet, silbergrau
 K = korrosionsgeschützt, schwarz

Powder-coated, silver-grey
K = corrosion-resistant, black

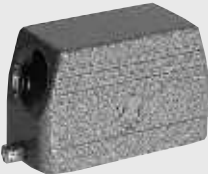
Längsbügel am Unterteil/Side clip at housing bottom

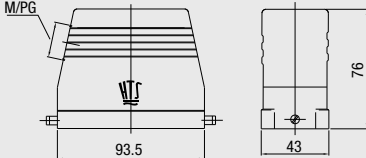
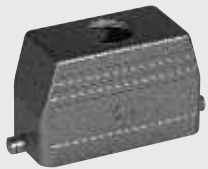
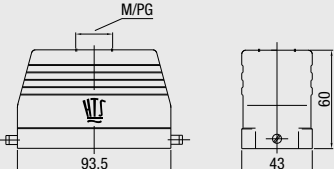
IP 65

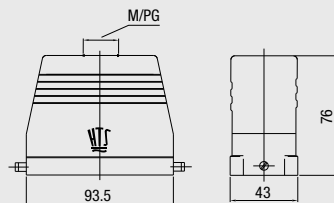
Bezeichnung Description	Metr.	PG	Bestelltext Designation	Bestell-Nr. Order No.
Steckergehäuse: Kabeleingang seitlich, Standard Bauform <i>Hood:</i> Side entry, Standard construction  	M32	21	HB.16.STS-GR.1.21.G HB.16.STS-GR.1.M32.G	1-1102292-7 0-1106449-5
	M32	21	Mit Korrosionsschutz <i>With corrosion protection</i> HB-K.16.STS-GR.1.21.G HB-K.16.STS-GR.1.M32.G	2-1102292-7 1-1106449-1
Steckergehäuse: Kabeleingang seitlich, Hohe Bauform <i>Hood:</i> Side entry, High construction  	M32	21 29	HD.40.STS-GR.1.21.G HD.40.STS-GR.1.29.G HD.40.STS-GR.1.M32.G	1-1102564-7 1-1102567-7 0-1106452-5
	M32	21 29	Mit Korrosionsschutz <i>With corrosion protection</i> HD-K.40.STS-GR.1.21.G HD-K.40.STS-GR.1.29.G HD-K.40.STS-GR.1.M32.G	2-1102564-7 2-1102567-7 1-1106452-1
Steckergehäuse: Kabeleingang oben, Standard Bauform <i>Hood:</i> Top entry, Standard construction  	M32	21	HB.16.STO-GR.1.21.G HB.16.STO-GR.1.M32.G	1-1102295-7 0-1106449-2
	M32	21	Mit Korrosionsschutz <i>With corrosion protection</i> HB-K.16.STO-GR.1.21.G HB-K.16.STO-GR.1.M32.G	2-1102295-7 0-1106449-8
Steckergehäuse: Kabeleingang oben, Hohe Bauform <i>Hood:</i> Top entry, High construction  	M32	21 29	HD.40.STO-GR.1.21.G HD.40.STO-GR.1.29.G HD.40.STO-GR.1.M32.G	1-1102570-7 1-1102573-7 0-1106452-2
	M32	21	Mit Korrosionsschutz <i>With corrosion protection</i> HD-K.40.STO-GR.1.21.G HD-K.40.STO-GR.1.M32.G	2-1102570-7 0-1106452-8

Passende Kabelverschraubungen ab Seite 188/Suitable Cable fittings from page 188

HB.16, HB-K.16, HD.40, HD-K.40 Gehäuse/Housings

Baugröße/Size 6

Pulverbeschichtet, silbergrau
 K = korrosionsgeschützt, schwarz

Powder-coated, silver-grey
K = corrosion-resistant, black

Längsbügel am Unterteil/Side clip at housing bottom

IP 65

Bezeichnung Description	Metr.	PG	Bestelltext Designation	Bestell-Nr. Order No.
<p>Anbaugehäuse: Kabeleingang unten, Standard Bauform <i>Surface mounted housing: Bottom entry, Standard construction</i></p>			<p>HB.16.AG-LB Mit Korrosionsschutz <i>With corrosion protection</i> HB-K.16.AG-LB</p>	<p>1-1102296-2 2-1102296-2</p>
<p>Anbaugehäuse: Kabeleingang unten, Standard Bauform <i>Surface mounted housing: Bottom entry, Standard construction</i></p>			<p>HB.16.AGD-LB Mit Korrosionsschutz <i>With corrosion protection</i> HB-K.16.AGD-LB</p>	<p>1-1102305-2 2-1102305-2</p>
<p>Sockelgehäuse: Kabeleingang seitlich, Standard Bauform <i>Surface mounted housing: Side entry, Standard construction</i></p>	M25 2xM25	21 2x21	<p>HB.16.SG-LB.1.21.Z HB.16.SG-LB.2.21.Z HB.16.SG-LB.1.M25.Z HB.16.SG-LB.2.M25.Z Mit Korrosionsschutz <i>With corrosion protection</i> HB-K.16.SG-LB.2.M25.Z</p>	<p>1-1102299-2 1-1102301-2 0-1103060-3 0-1106448-3 0-1106448-7</p>
<p>Sockelgehäuse: Kabeleingang seitlich, Hohe Bauform <i>Surface mounted housing: Side entry, High construction</i></p>	2xM32	21 2x21 29 2x29	<p>HD.40.SG-LB.1.21.Z HD.40.SG-LB.2.21.Z HD.40.SG-LB.1.29.Z HD.40.SG-LB.2.29.Z HD.40.SG-LB.2.M32.Z Mit Korrosionsschutz <i>With corrosion protection</i> HD-K.40.SG-LB.1.21.Z HD-K.40.SG-LB.2.M32.Z</p>	<p>1-1102575-2 1-1102577-2 1-1102579-2 1-1102581-2 0-1106451-3 2-1102575-2 0-1106451-7</p>

Passende Kabelverschraubungen ab Seite 188/Suitable Cable fittings from page 188

HB.16, HB-K.16, HD.40, HD-K.40 Gehäuse/Housings

Baugröße/Size 6

Pulverbeschichtet, silbergrau
 K = korrosionsgeschützt, schwarz

Powder-coated, silver-grey
K = corrosion-resistant, black

Längsbügel am Unterteil/Side clip at housing bottom

IP 65

Bezeichnung Description	Metr.	PG	Bestelltext Designation	Bestell-Nr. Order No.
Sockelgehäuse: Kabeleingang seitlich, Standard Bauform <i>Surface mounted housing: Side entry, Standard construction</i> 	2xM25	21 2x21	HB.16.SGD-LB.1.21.Z HB.16.SGD-LB.2.21.Z HB.16.SGD-LB.2.M25.Z	1-1102308-2 1-1102310-2 0-1106448-2
		21 2x21	Mit Korrosionsschutz <i>With corrosion protection</i> HB-K.16.SGD-LB.1.21.Z HB-K.16.SGD-LB.2.21.Z HB-K.16.SGD-LB.2.M25.Z	2-1102308-2 2-1102310-2 0-1106448-6
Sockelgehäuse: Kabeleingang seitlich, Hohe Bauform <i>Surface mounted housing: Side entry, High construction</i> 	2xM32	21 2x21 29 2x29	HD.40.SGD-LB.1.21.Z HD.40.SGD-LB.2.21.Z HD.40.SGD-LB.1.29.Z HD.40.SGD-LB.2.29.Z HD.40.SGD-LB.2.M32.Z	1-1102589-2 1-1102591-2 1-1102593-2 1-1102595-2 0-1106451-2
		21 2x21 29 2x29	Mit Korrosionsschutz <i>With corrosion protection</i> HD-K.40.SGD-LB.1.21.Z HD-K.40.SGD-LB.2.21.Z HD-K.40.SGD-LB.1.29.Z HD-K.40.SGD-LB.2.29.Z HD-K.40.SGD-LB.2.M32.Z	2-1102589-2 2-1102591-2 2-1102593-2 2-1102595-2 0-1106451-6
Kupplungsgehäuse: Kabeleingang unten, Hohe Bauform <i>Cable-to-cable hood: Bottom entry, High construction</i> 	M32	21 29	HD.40.KDO-LB.1.21.G HD.40.KDO-LB.1.29.G HD.40.KDO-LB.1.M32.G	1-1102584-2 1-1102587-2 0-1106450-1
		M32	Mit Korrosionsschutz <i>With corrosion protection</i> HD-K.40.KDO-LB.1.M32.G	0-1106450-3

Passende Kabelverschraubungen ab Seite 188/Suitable Cable fittings from page 188

HB-Z.16, HB-K/Z.16, HD-Z.40, HD-K/Z.40 Gehäuse/Housings





Baugröße/Size 6

Pulverbeschichtet, silbergrau
 K = korrosionsgeschützt, schwarz

Powder-coated, silver-grey
K = corrosion-resistant, black

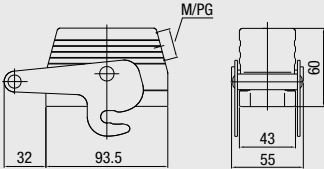
Zentralbügel am Steckergehäuse/Central locking clip on hood

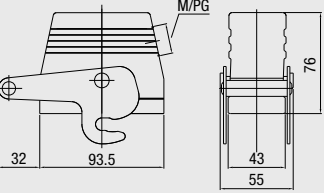
IP 65

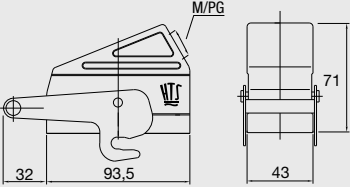
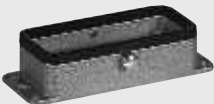
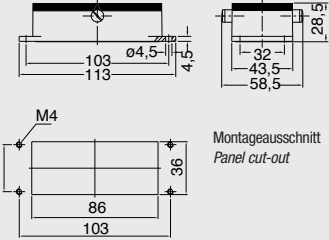
Bezeichnung Description	Metr.	PG	Bestelltext Designation	Bestell-Nr. Order No.
Steckergehäuse: Kabeleingang seitlich, Standard Bauform Hood: Side entry, Standard construction  	M32	21	HB-Z.16.STS-ZB.1.21.G HB-Z.16.STS-ZB.1.M32.G Mit Korrosionsschutz With corrosion protection HB-K/Z.16.STS-ZB.1.21.G HB-K/Z.16.STS-ZB.1.M32.G	1-1102292-3 2-1106449-4 2-1102292-3 1-1106449-4
Steckergehäuse: Kabeleingang seitlich, Hohe Bauform Hood: Side entry, High construction  	M32	21 29	HD-Z.40.STS-ZB.1.21.G HD-Z.40.STS-ZB.1.29.G HD-Z.40.STS-ZB.1.M32.G Mit Korrosionsschutz With corrosion protection HD-K/Z.40.STS-ZB.1.21.G HD-K/Z.40.STS-ZB.1.29.G HD-K/Z.40.STS-ZB.1.M32.G	1-1102564-3 1-1102567-3 1-1106452-6 2-1102564-3 2-1102567-3 1-1106452-4
Steckergehäuse: Kabeleingang seitlich, Keilform Hood: Side entry, Standard construction  	M32	21	HB-KF-Z.16.STS-ZB.1.21.G HB-KF-Z.16.STS-ZB.1.M32.G Mit Korrosionsschutz With corrosion protection HB-KF/K-Z.16.STS-ZB.1.21.Z HB-KF/K-Z.16.STS-ZB.1.M32.Z	1-1102220-3 2-1106449-2 2-1102220-3 2-1106449-1
Anbauehäuse: Kabeleingang unten, Standard Bauform Surface mounted housing: Bottom entry, Standard construction  			HB-Z.16.AG-ZVGR Mit Korrosionsschutz With corrosion protection HB-K/Z.16.AG-ZVGR	1-1102296-8 2-1102296-8

Passende Kabelverschraubungen ab Seite 188/Suitable Cable fittings from page 188

HB-Z.16, HB-K/Z.16, HD-Z.40, HD-K/Z.40 Gehäuse/Housings



Baugröße/Size 6

Pulverbeschichtet, silbergrau
 K = korrosionsgeschützt, schwarz

Powder-coated, silver-grey
K = corrosion-resistant, black

Zentralbügel am Steckergehäuse/Central locking clip on hood

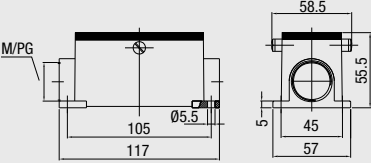
IP 65

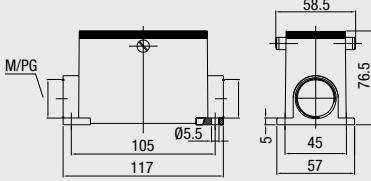
Bezeichnung Description	Metr.	PG	Bestelltext Designation	Bestell-Nr. Order No.
<p>Sockelgehäuse: Kabeleingang seitlich, Standard Bauform <i>Surface mounted housing: Side entry, Standard construction</i></p>  	2xM25	21 2x21	HB-Z.16.SG-ZVGR.1.21.Z HB-Z.16.SG-ZVGR.2.21.Z HB-Z.16.SG-ZVGR.2.M25.G Mit Korrosionsschutz <i>With corrosion protection</i>	1-1102299-8 1-1102301-8 1-1106448-1
		21 2x21	HB-K/Z.16.SG-ZVGR.1.21.Z HB-K/Z.16.SG-ZVGR.2.21.Z HB-K/Z.16.SG-ZVGR.2.M25.G	2-1102299-8 2-1102301-8 1-1106448-0
<p>Sockelgehäuse: Kabeleingang seitlich, Hohe Bauform <i>Surface mounted housing: Side entry, High construction</i></p>  	2xM32		HD-Z.40.SG-ZVGR.2.M32.G Mit Korrosionsschutz <i>With corrosion protection</i>	1-1106451-0
	2xM32		HD-K/Z.40.SG-ZVGR.2.M32.G	0-1106451-9

Passende Kabelverschraubungen ab Seite 188/Suitable Cable fittings from page 188

HIP.16/40, HIP-K.16/40, EMV-K.16/40 Gehäuse/Housings

Baugröße/Size 6

HIP: Druckdicht, silbergrau, **HIP-K:** Korrosionsgeschützt, schwarz





EMV-K: Schutz gegen elektromagnetische Beeinflussung, druckdicht, korrosionsgeschützt, schwarz

HIP: Pressure-tight, silver-grey, **HIP-K:** Housings corrosion-resistant, black

EMV-K: Protection against electro-magnetic interference, pressure-tight, housings corrosion-resistant, black

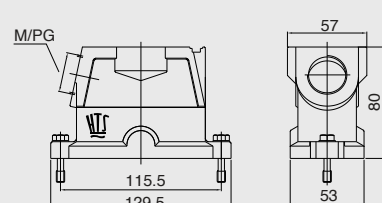
Druckdicht bis ≤ 5 bar/pressure-tight up to 5 bar

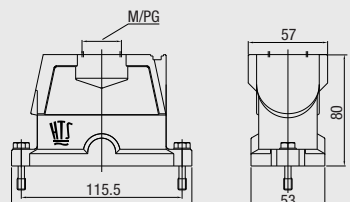
IP 68

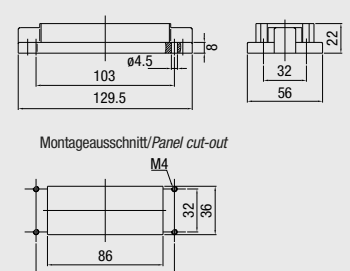
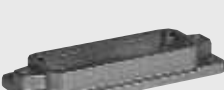
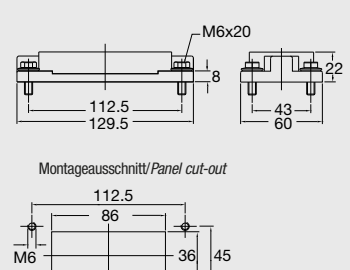
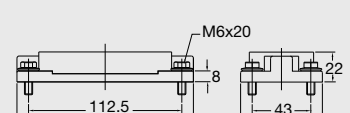
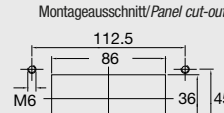
Bezeichnung Description	Metr.	PG	Bestelltext Designation	Bestell-Nr. Order No.	
Steckergehäuse: Kabeleingang seitlich Hood: Side entry  	M32	21	HIP HIP.16/40.STS.1.21.G	1-1102649-5	
		29	HIP.16/40.STS.1.29.G HIP.16/40.STS.1.M32.G	1-1102651-5 0-1106454-2	
	M32	29	HIP-K HIP-K.16/40.STS.1.29.G	2-1102651-5	
			HIP-K.16/40.STS.1.M32.G	0-1106444-2	
	M32	29	EMV-K EMV-K.16/40.STS.1.29.G	4-1102723-5	
		21	EMV-K.16/40.STS.1.M32.G EMV-K.16/40.STS.1.21.G	0-1106446-4 4-1102722-5	
Steckergehäuse: Kabeleingang oben Hood: Top entry  	M32	21	HIP HIP.16/40.STO.1.21.G	1-1102653-5	
		29	HIP.16/40.STO.1.29.G HIP.16/40.STO.1.M32.G	1-1102655-5 0-1106454-1	
	M32	21	HIP-K HIP-K.16/40.STO.2.21.G	0-1108534-1	
		29	HIP-K.16/40.STO.1.29.G HIP-K.16/40.STO.1.M32.G	2-1102655-5 0-1106444-1	
	M32		EMV-K EMV-K.16/40.STO.1.29.G	4-1102725-5	
			EMV-K.16/40.STO.1.M32.G	0-1106446-3	
Anbaugehäuse: Kabeleingang unten Surface mounted housing: Bottom entry   <p>Montageausschnitt/Panel cut-out</p> 			HIP HIP.16/40.AG	1-1102656-5	
			HIP-K HIP-K.16/40.AG	2-1102656-5	
			EMV-K EMV-K.16/40.AG	4-1102728-5	
	Anbaugehäuse: Kabeleingang unten Surface mounted housing: Bottom entry   <p>Montageausschnitt/Panel cut-out</p> 			HIP HIP.16/40.AG.M6	1-1102618-5
				HIP-K HIP-K.16/40.AG.M6	2-1102618-5
			EMV-K EMV-K.16/40.AG.M6	4-1102730-5	

Passende Kabelverschraubungen ab Seite 188/Suitable Cable fittings from page 188

HIP.16/40, HIP-K.16/40, EMV-K.16/40 Gehäuse/Housings

Baugröße/Size 6

HIP: Druckdicht, silbergrau, **HIP-K:** Korrosionsgeschützt, schwarz

EMV-K: Schutz gegen elektromagnetische Beeinflussung, druckdicht, korrosionsgeschützt, schwarz

HIP: Pressure-tight, silver-grey, **HIP-K:** Housings corrosion-resistant, black

EMV-K: Protection against electro-magnetic interference, pressure-tight, housings corrosion-resistant, black

Druckdicht bis ≤ 5 bar/pressure-tight up to 5 bar

IP 68

Bezeichnung Description	Metr.	PG	Bestelltext Designation	Bestell-Nr. Order No.
Sockelgehäuse: Kabeleingang seitlich Surface mounted housing: Side entry				
		2xM32	HIP HIP.16/40.SG.1.21.G HIP.16/40.SG.2.21.G HIP.16/40.SG.2.M32.G	1-1102616-5 1-1102617-5 0-1106453-1
Schutzkappe für Gehäuse-Unterteile Protective covers for housings	2xM32	21 2x21	HIP-K HIP-K.16/40.SG.1.21.G HIP-K.16/40.SG.2.21.G HIP-K.16/40.SG.2.M32.G	5-1102616-5 2-1102617-5 0-1106443-1
		21 2x21	EMV-K EMV-K.16/40.SG.1.21.Z EMV-K.16/40.SG.2.21.Z EMV-K.16/40.SG.2.M32.G	4-1102726-5 4-1102727-5 0-1106445-2
			HIP HIP/EMV.16/40.SKB	3-1106203-5
			HIP-K HIP-K.16/40.SKB	4-1106203-5

Passende Kabelverschraubungen ab Seite 188/Suitable Cable fittings from page 188

HA.32 Kontakteinsätze/Contact inserts

Baugröße/Size 7

Schraubanschluss, Federzug-Anschluss,
Crimpanschluss für gedrehte HE/HA Crimpkontakte

Kontaktzahlen
No. of contacts

*Screw terminal, Spring Clamp terminal,
Crimp terminal for screw machined HE/HA crimp contacts*

(2 x 16) **32 +**

250 V/16 A

Bezeichnung Description	Bestelltext Designation	Bestell-Nr./Order No.											
		Stifteinsatz Male insert	Buchseinsatz Female insert										
<p>Stifteinsatz/Male insert</p> <p>Schraubanschluss/Screw terminal</p>	<p>HA.16.Sti.S.B 1-16 HA.16.Sti.S.B 17-32</p>	<p>1-1103416-1 1-1103416-7</p>											
<p>Buchseinsatz/Female insert</p> <p>Schraubanschluss/Screw terminal</p>	<p>HA.16.Bu.S.B 1-16 HA.16.Bu.S.B 17-32</p>		<p>1-1103417-1 1-1103417-7</p>										
<p>Federzug-Anschluss/Spring Clamp terminal</p>	<p>HA.16.Sti.SC.B 1-16 HA.16.Sti.SC.B 17-32</p>	<p>7-1103416-1 7-1103416-7</p>											
<p>Buchseinsatz/Female insert</p> <p>Federzug-Anschluss/Spring Clamp terminal</p>	<p>HA.16.Bu.SC.B 1-16 HA.16.Bu.SC.B 17-32</p>		<p>7-1103417-1 7-1103417-7</p>										
<p>Crimpanschluss/Crimp terminal</p>	<p>HA.16.STI.C.B 1-16 HA.16.STI.C.B 17-32</p>	<p>2-1103416-3 2-1103416-7</p>											
<p>Buchseinsatz/Female insert</p> <p>Crimpanschluss/Crimp terminal</p>	<p>HA.16.BU.C.B 1-16 HA.16.BU.C.B 17-32</p>		<p>2-1103417-3 2-1103417-7</p>										
<p>Maße/Dimensions</p> <table border="1"> <tr> <td>A</td> <td>B</td> <td>C</td> <td>D</td> <td>E</td> </tr> <tr> <td>66</td> <td>73</td> <td>23</td> <td>31</td> <td>28</td> </tr> </table>	A	B	C	D	E	66	73	23	31	28			
A	B	C	D	E									
66	73	23	31	28									

Passende Crimpkontakte siehe Seite 37, Passende Crimpwerkzeuge siehe Seite 37
Suitable Crimp contacts see page 37, Suitable Crimping tools see page 37

Maßbild mm/Dimensions mm

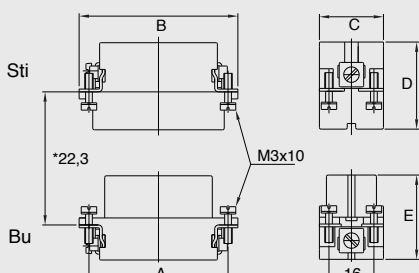

Anschlußseite Stift
Contact arrangement Male insert



Anschlußseite Buchse
Contact arrangement Female insert



*Abstand für sichere Kontaktgabe max. 24 mm

HN.D.50 Kontakteinsätze/Contact inserts

Baugröße/Size 7



Crimpschluss für gedrehte HN.D Crimpkontakte

**Kontaktzahlen
No. of contacts**

Crimp terminal for screw machined HN.D crimp contacts

(2 x 25) **50 +**

250 V/10 A

Bezeichnung Description	Bestelltext Designation	Bestell-Nr./Order No.	
		Stifteinsatz Male insert	Buchseinsatz Female insert
<p>Stifteinsatz/Male insert</p> <p>Crimpschluss/Crimp terminal</p> 	<p>HN.D.25.Sti.C HN.D.25.Sti.C.1-25/Z*</p>	<p>2-1103108-3 0-1103108-1</p>	
<p>Buchseinsatz/Female insert</p> 	<p>HN.D.25.Bu.C HN.D.25.Bu.C.1-25/Z*</p>		<p>2-1103109-3 0-1103109-1</p>

*Zusätzliche Kennzeichnung „Z“ wie in Euromap 67 hinterlegt
*Marked with „Z“ according Euromap 67

Maße/Dimensions	A	B	C	D	E
mm	66	73	23	35	35

Passende Crimpkontakte siehe Seite 34, Passende Crimpwerkzeuge siehe Seite 34
Suitable Crimp contacts see page 34, Suitable Crimping tools see page 34

Maßbild mm
Dimensions mm

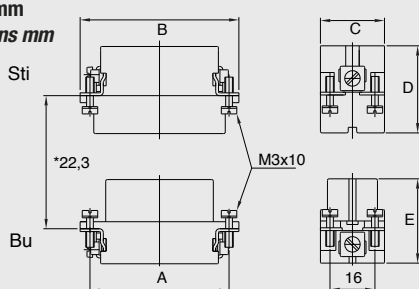

Anschlußseite Stift
Contact arrangement Male insert



Anschlußseite Buchse
Contact arrangement Female insert



HD.50 Kontakteinsätze/Contact inserts

Baugröße/Size 7



Crimpschluss für gestanzte HD.M Crimpkontakte

**Kontaktzahlen
No. of contacts**

Crimp terminal for stamped HD .Mcrimp contacts

(2 x 25) **50 +**

250 V/10 A

Bezeichnung Description	Bestelltext Designation	Bestell-Nr./Order No.	
		Stifteinsatz Male insert	Buchseinsatz Female insert
<p>Stifteinsatz/Male insert</p> <p>Crimpschluss/Crimp terminal</p> 	HD.25.Sti.C	2-1103010-3	
<p>Buchseinsatz/Female insert</p> 	HD.25.Bu.C		2-1103011-3

Maße/Dimensions	A	B	C	D	E
mm	66	73	23	35	35

Passende Crimpkontakte siehe Seite 35, Passende Crimpwerkzeuge siehe Seite 35
 Suitable Crimp contacts see page 35, Suitable Crimping tools see page 35

Maßbild mm
 Dimensions mm

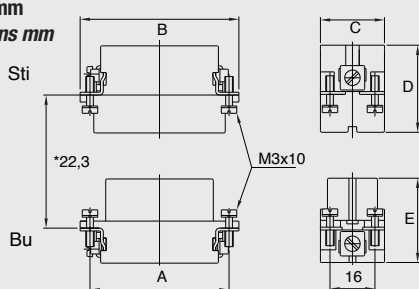

Anschlußseite Stift
 Contact arrangement Male insert



Anschlußseite Buchse
 Contact arrangement Female insert



HA.32 Gehäuse/Housings

Baugröße/Size 7

Pulverbeschichtet, silbergrau

Powder-coated, silver-grey

Verschlussbügel am Unterteil/Locking clip at housing bottom

IP 65

Bezeichnung Description	Metr.	PG	Bestelltext Designation	Bestell-Nr. Order No.
<p>Steckergehäuse: Kabeleingang seitlich, Standard Bauform <i>Hood: Side entry, Standard construction</i></p>	M25 M40	21	HA.32.STS.1.21.G HA.32.STS.1.M25.G HA.32.STS.1.M40.G	1-1102155-6 0-1106456-3 0-1106439-3
<p>Steckergehäuse: Kabeleingang oben, Standard Bauform <i>Hood: Top entry, Standard construction</i></p>	M32 M40	21	HA.32.STO.1.21.G HA.32.STO.1.M32.G HA.32.STO.1.M40.G	1-1102158-6 0-1106456-1 0-1106439-1
<p>Anbaugeschäuse: Kabeleingang unten, Standard Bauform <i>Surface mounted housing: Bottom entry, Standard construction</i></p>			HA.32.AG-VS	1-1102160-1
<p>Sockelgehäuse: Kabeleingang seitlich, Standard Bauform <i>Surface mounted housing: Side entry, Standard construction</i></p>	2xM25	21 2x21	HA.32.SG-VS.1.21.Z HA.32.SG-VS.2.21.Z HA.32.SG-VS.2.M25.Z	1-1102162-1 1-1102164-1 0-1106455-2

Passende Kabelverschraubungen ab Seite 188/Suitable Cable fittings from page 188

HA.32 Gehäuse/Housings

Baugröße/Size 7

Pulverbeschichtet, silbergrau

Powder-coated, silver-grey

Verschlussbügel am Oberteil/Locking clip on hood

IP 65

Bezeichnung Description	Metr.	PG	Bestelltext Designation	Bestell-Nr. Order No.
<p>Steckergehäuse: Kabeleingang seitlich, Standard Bauform <i>Hood: Side entry, Standard construction</i></p>	M25 M40	21	HA.32.STS-VS.1.21.G HA.32.STS-VS.1.M25.G HA.32.STS-VS.1.M40.G	1-1102155-1 0-1106456-4 0-1106459-4
<p>Steckergehäuse: Kabeleingang oben, Standard Bauform <i>Hood: Top entry, Standard construction</i></p>	M32 M40	21	HA.32.STO-VS.1.21.G HA.32.STO-VS.1.M32.G HA.32.STO-VS.1.M40.G	1-1102158-1 0-1106456-2 0-1106459-2
<p>Anbaugeschäuse: Kabeleingang unten, Standard Bauform <i>Surface mounted housing: Bottom entry, Standard construction</i></p>			HA.32.AGD	1-1102165-1
<p>Sockelgehäuse: Kabeleingang seitlich, Standard Bauform <i>Surface mounted housing: Side entry, Standard construction</i></p>	2xM25	21 2x21	HA.32.SGD.1.21.Z HA.32.SGD.2.21.Z HA.32.SGD.2.M25.Z	1-1102167-1 1-1102169-1 0-1106455-1

Passende Kabelverschraubungen ab Seite 188/Suitable Cable fittings from page 188

Verbindlich für Toleranzen der Abmessungen und technische Werte sind ausschließlich die neuesten TE Connectivity Kundenzeichnungen bzw. Produkt-Spezifikationen, die Sie auf Anfrage erhalten.
All specifications subject to change. Consult TE Connectivity for latest design specifications.

HE.24 Kontakteinsätze/Contact inserts

Baugröße/Size 8

Federzug-Anschluss, Schraubanschluss,
Crimpschluss für gedrehte HE/HA Crimpkontakte

**Kontaktzahlen
No. of contacts**

*Spring Clamp terminal, Screw terminal,
Crimp terminal for screw machined HE/HA crimp contacts*

24 +

400 V/16 A

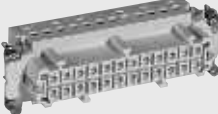
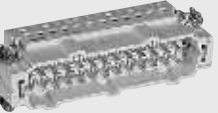
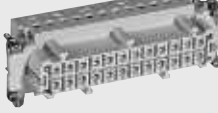
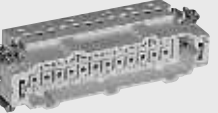
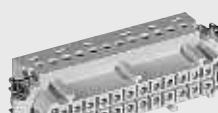
Bezeichnung Description	Bestelltext Designation	Bestell-Nr./Order No.	
		Stifteinsatz Male insert	Buchseinsatz Female insert
<p>Stifteinsatz/Male insert</p> <p>Schraubanschluss/Screw terminal</p> 	HE.24.Sti.S.B 1-24	1-1103640-1	
<p>Buchseinsatz/Female insert</p> 	HE.24.Bu.S.B 1-24		1-1103641-1
<p>Federzug-Anschluss/Spring Clamp terminal</p> 	HE.24.Sti.SC.B 1-24	7-1103640-1	
<p>Buchseinsatz/Female insert</p> 	HE.24.Bu.SC.B 1-24		7-1103641-1
<p>Crimpschluss/Crimp terminal</p> 	HE.24.Sti.C.B 1-24	2-1103640-3	
<p>Buchseinsatz/Female insert</p> 	HE.24.Bu.C.B 1-24		2-1103641-3

Maße/Dimensions	A	B	C	D	E
mm	104	110	33	34	35

Passende Crimpkontakte siehe Seite 37, Passende Crimpwerkzeuge siehe Seite 37
 Suitable Crimp contacts see page 37, Suitable Crimping tools see page 37

Maßbild mm
Dimensions mm

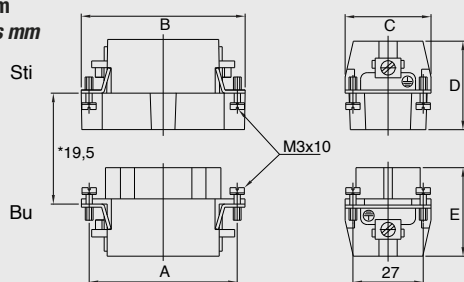

*Abstand für sichere Kontaktgabe max. 21 mm

Anschlußseite Stift
Contact arrangement Male insert

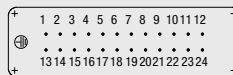

Anschlußseite Buchse
Contact arrangement Female insert

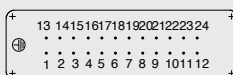

Montageausschnitt
Panel cut-out

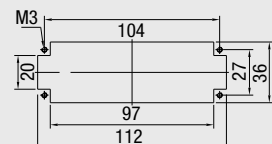

HEE.46 Kontakteinsätze/Contact inserts

Baugröße/Size 8

Crimpanschluss für gedrehte HE Crimpkontakte

**Kontaktzahlen
No. of contacts**

Crimp terminal for screw machined HE crimp contacts

46 +

500 V/16 A

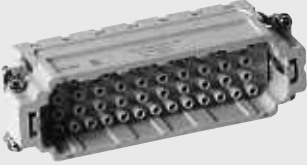
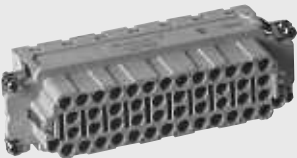
Bezeichnung Description	Bestelltext Designation	Bestell-Nr./Order No.	
		Stifteinsatz Male insert	Buchseinsatz Female insert
<p>Stifteinsatz/Male insert</p> <p>Crimpanschluss/Crimp terminal</p> 	<p>HEE.46.Sti.C</p> <p>HEE.46.Sti.C.FS*</p>	<p>0-1102886-1</p> <p>0-1102886-4</p>	
<p>Buchseinsatz/Female insert</p> 	<p>HEE.46.Bu.C</p> <p>HEE.46.Bu.C.FS*</p>		<p>0-1102887-1</p> <p>0-1102887-4</p>

*Kunststoff ist I2F1 qualifiziert nach NF-F 16-101, 102
Plastic is qualified I2F1 according NF-F 16-101, 102

Maße/Dimensions	A	B	C	D	E
mm	104	110	33	34	37

Passende Crimpkontakte siehe Seite 37, Passende Crimpwerkzeuge siehe Seite 37
Suitable Crimp contacts see page 37, Suitable Crimping tools see page 37

Maßbild mm
Dimensions mm

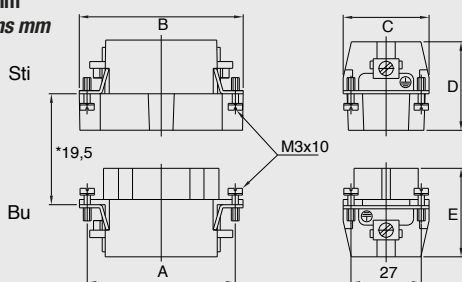

Kontaktanordnung Anschlußseite Stift
Contact arrangement Male insert

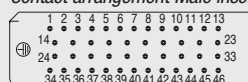

Kontaktanordnung Anschlußseite Buchse
Contact arrangement Female insert

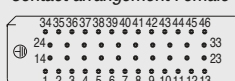

Montageausschnitt
Panel cut-out

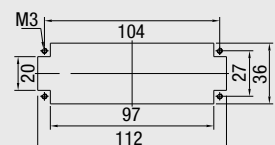

HVT.35; HVT.48 Kontakteinsätze/Contact inserts

Baugröße/Size 8

Crimpanschluss für gedrehte HVT Crimpkontakte

**Kontaktzahlen
No. of contacts**

Crimp terminal for screw machined HVT crimp contacts

35; 48 +

400 V/16 A

Bezeichnung Description	Bestelltext Designation	Bestell-Nr./Order No.	
		Stifteinsatz Male insert	Buchseinsatz Female insert
Stifteinsatz/Male insert Crimpanschluss/Crimp terminal 	HVT.35.Sti.C	2-1104012-3	
Buchseinsatz/Female insert 	HVT.35.Bu.C		2-1104014-3
Crimpanschluss/Crimp terminal 	HVT.48.Sti.C	2-1104016-3	
	HVT.48.Bu.C		2-1104018-3

Maße/Dimensions	A	B	C	D	E
mm	104	110	33	35	40

Passende Crimpkontakte siehe Seite 38, Passende Crimpwerkzeuge siehe Seite 38
 Suitable Crimp contacts see page 38, Suitable Crimping tools see page 38

Maßbild mm/Dimensions mm

*Abstand für sichere Kontaktgabe max. 21 mm

Anschlußseite Stift/Contact arrangement Male insert

HVT.35

HVT.48

Anschlußseite Buchse/Contact arrangement Female insert

HVT.35

HVT.48

**Montageausschnitt
Panel cut-out**

HN.D.64; HN.2D.108 Kontakteinsätze/Contact inserts

Baugröße/Size 8

Crimpanschluss für gedrehte HN.D Crimpkontakte

Kontaktzahlen

No. of contacts

Crimp terminal for screw machined HN.D crimp contacts

64; 108 +

250 V/10 A

Bezeichnung Description	Bestelltext Designation	Bestell-Nr./Order No.	
		Stifteinsatz Male insert	Buchseinsatz Female insert
<p>Stifteinsatz/Male insert</p> <p>Crimpanschluss/Crimp terminal</p>	HN.D.64.Sti.C	2-1103112-3	
<p>Buchseinsatz/Female insert</p>	HN.D.64.Bu.C		2-1103113-3
<p>Crimpanschluss/Crimp terminal</p>	HN.2D.108.Sti.C	2-1103216-3	
	HN.2D.108.Bu.C		2-1103220-3

HN.D.64

Maße/Dimensions	A	B	C	D	E
mm	104	110	33	35	35

HN.2D.108

Maße/Dimensions	A	B	C	D	E
mm	104	110	34	36,5	37

Passende Crimpkontakte siehe Seite 34, Passende Crimpwerkzeuge siehe Seite 34
 Suitable Crimp contacts see page 34, Suitable Crimping tools see page 34

Maßbild mm/Dimensions mm

*Abstand für sichere Kontaktgabe max. 21 mm

Anschlußseite Stift/Contact arrangement Male insert

HN.D.64 HN.2D.108

Anschlußseite Buchse/Contact arrangement Female insert

HN.D.64 HN.2D.108

Montageausschnitt
Panel cut-out

HD.64 Kontakteinsätze/Contact inserts

Baugröße/Size 8

Crimpanschluss für gestanzte HD.M Crimpkontakte

**Kontaktzahlen
No. of contacts**

Crimp terminal for stamped HD.M crimp contacts

64 +

250 V/10 A

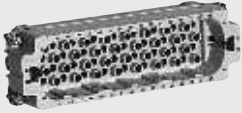
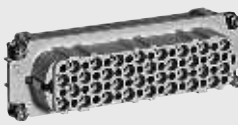
Bezeichnung Description	Bestelltext Designation	Bestell-Nr./Order No.	
		Stifteinsatz Male insert	Buchseinsatz Female insert
<p>Stifteinsatz/Male insert</p> <p>Crimpanschluss/Crimp terminal</p> 	HD.64.Sti.C	2-1103032-3	
<p>Buchseinsatz/Female insert</p> 	HD.64.Bu.C		2-1103033-3

Maße/Dimensions	A	B	C	D	E
mm	104	110	33	35	35

Passende Crimpkontakte siehe Seite 35, Passende Crimpwerkzeuge siehe Seite 35
 Suitable Crimp contacts see page 35, Suitable Crimping tools see page 35

**Maßbild mm
Dimensions mm**

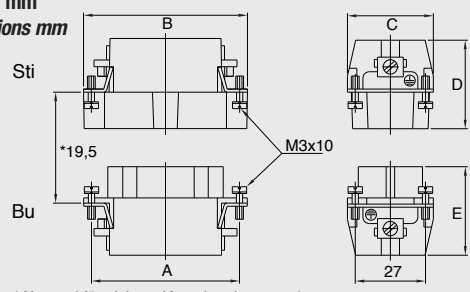

*Abstand für sichere Kontaktgabe max. 21 mm

Anschiußseite Stift
Contact arrangement Male insert

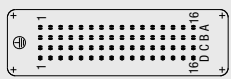

Anschiußseite Buchse
Contact arrangement Female insert

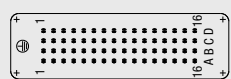

Montageausschnitt
Panel cut-out

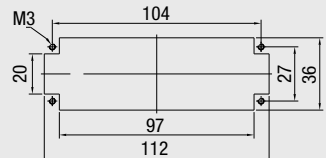

HSS.8/2; HMX4/8 Kontakteinsätze/Contact inserts

Baugröße/Size 8

Crimpanschluss, Schraubanschluss

Kontaktzahlen

No. of contacts

Crimp terminal, Screw terminal

8 + 2; 4 + 8

600 V/63 A; 400 V/16 A; 380 V/80 A; 380 V/16 A

Bezeichnung Description		Bestelltext Designation	Bestell-Nr./Order No.		
			Stifteinsatz Male insert	Buchseinsatz Female insert	
Stifteinsatz/Male insert	Buchseinsatz/Female insert				
Crimpanschluss/Crimp terminal		HSS.8/2.Sti.C	2-1104200-3		
		HSS.8/2.Bu.C		2-1104202-3	
Schraubanschluss/Screw terminal		HMX.4/8.Sti.S	0-1103148-1		
		HMX.4/8.Bu.S		0-1103149-1	

HSS.8/2					
Maße/Dimensions	A	B	C	D	E
mm	104	110	33	40	43,5

HMX4/8					
Maße/Dimensions	A	B	C	D	E
mm	104	110	34	42	44

Passende Crimpkontakte siehe Seite 38 (Steuerkontakt), Seite 41 (Lastkontakt), Passende Crimpwerkzeuge siehe Seite 41
 Suitable Crimp contacts see page 38 (signal contact), page 41 (power contact), Suitable Crimping tools see page 41

<p>Maßbild mm/Dimensions mm</p>	<p>Anschlußseite Stift/Contact arrangement Male insert HSS.8/2</p>	<p>Anschlußseite Buchse/Contact arrangement Female insert HSS.8/2</p>	<p>Montageausschnitt Panel cut-out</p>
	<p>Anschlußseite Stift/Contact arrangement Male insert HE-K.4/8</p>	<p>Anschlußseite Buchse/Contact arrangement Female insert HE-K.4/8</p>	

*Abstand für sichere Kontaktgabe max. 21 mm

Modul Halterahmen/Module Fixing Frame

Baugröße/Size 8

**Bezeichnung
Description**

**Bestelltext
Designation**

**Bestell-Nr./Order No.
Oberteil
Top part** **Unterteil
Bottom part**

Halterahmen/Fixing frame



Für Modul MDL Seite 194–203
For module MDL page 194–203

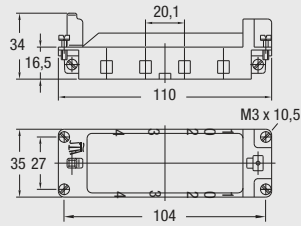

MDL2-GR.0-8/B.1-4

0-1108780-1

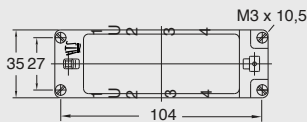

MDL2-GR.U-8/B.1-4

0-1108780-2

Montageausschnitt/Panel cut-out

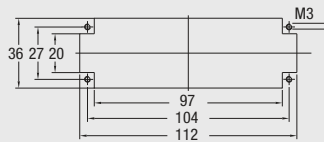

Halterahmen/Fixing frame

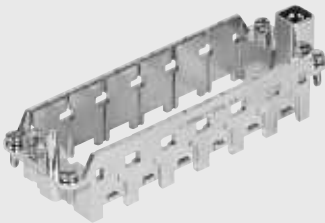

Für Modul HVS Seite 204–212
For module HVS page 204–212

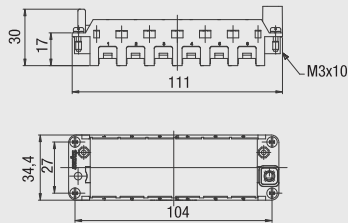

HVS-R.0 1-6
HVS-R.U 1-6

0-1103250-1

0-1103250-2

Montageausschnitt/Panel cut-out

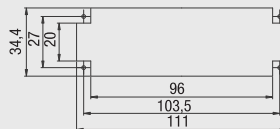

HB/-K.24, HD/-K.64, HD/-K.108 Gehäuse/Housings

Baugröße/Size 8

Pulverbeschichtet, silbergrau
 K = korrosionsgeschützt, schwarz

Powder-coated, silver-grey
K = corrosion-resistant, black

Verschlussbügel am Unterteil/Locking clip at housing bottom

IP 65

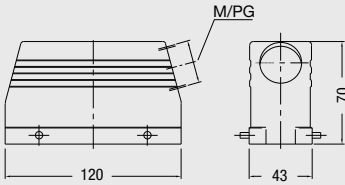
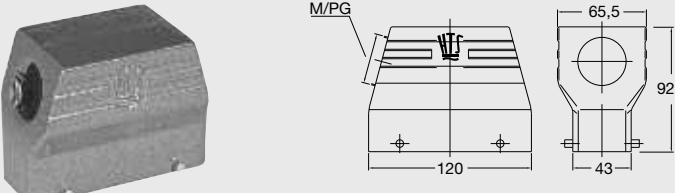
Bezeichnung Description	Metr.	PG	Bestelltext Designation	Bestell-Nr. Order No.	
Steckergehäuse: Kabeleingang seitlich, Standard Bauform <i>Hood:</i> Side entry, Standard construction 	M32	21	HB.24.STS.1.21.G	1-1102316-6	
		29	HB.24.STS.1.29.G	1-1102319-6	
			HB.24.STS.1.M32.G	0-1106465-4	
				Mit Korrosionsschutz <i>With corrosion protection</i>	
	M32	21	HB-K.24.STS.1.21.G	2-1102316-6	
		29	HB-K.24.STS.1.29.G	2-1102319-6	
		HB-K.24.STS.1.M32.G	1-1106465-1		
Steckergehäuse: Kabeleingang seitlich, Hohe Bauform <i>Hood:</i> Side entry, High construction 	M32 M40	21	HD.64.STS.1.21.G	1-1103336-6	
		29	HD.64.STS.1.29.G	1-1103338-6	
			HD.64.STS.1.M32.G	0-1106470-4	
			HD.64.STS.1.M40.G	1-1106470-9	
				Mit Korrosionsschutz <i>With corrosion protection</i>	
	M32	21	HD-K.64.STS.1.21.G	2-1103336-6	
29		HD-K.64.STS.1.29.G	2-1103338-6		
		HD-K.64.STS.1.M32.G	1-1106470-0		
Steckergehäuse: Kabeleingang seitlich, Hohe Bauform <i>Hood:</i> Side entry, High construction 	M50	29	HD.108.STS.1.29.G	1-1102411-6	
			HD.108.STS.1.M50.G	0-1106467-4	
				Mit Korrosionsschutz <i>With corrosion protection</i>	
	M50	29	HD-K.108.STS.1.29.G	2-1102411-6	
		HD-K.108.STS.1.M50.G	1-1106467-0		

Passende Kabelverschraubungen ab Seite 188/Suitable Cable fittings from page 188

HB/-K.24, HD/-K.64, HD/-K.108 Gehäuse/Housings





Baugröße/Size 8

Pulverbeschichtet, silbergrau
 K = korrosionsgeschützt, schwarz

Powder-coated, silver-grey
K = corrosion-resistant, black

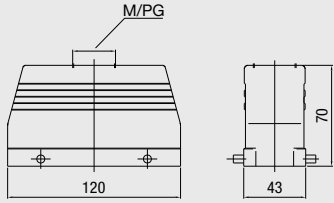
Verschlussbügel am Unterteil/Locking clip at housing bottom

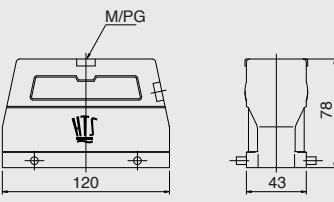
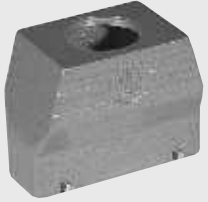
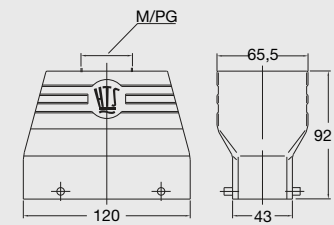
IP 65

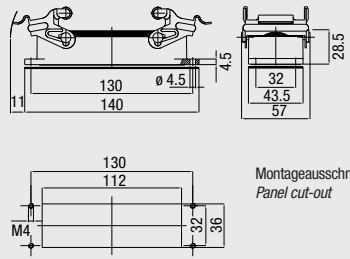
Bezeichnung Description	Metr.	PG	Bestelltext Designation	Bestell-Nr. Order No.
Steckergehäuse: Kabeleingang oben, Standard Bauform Hood: Top entry, Standard construction  	M32	21	HB.24.STO.1.21.G	1-1102325-6
		29	HB.24.STO.1.29.G HB.24.STO.1.M32.G	1-1102328-6 0-1106465-1
Steckergehäuse: Kabeleingang oben, Hohe Bauform Hood: Top entry, High construction  	M32 M40	21	HD.64.STO.1.21.G	1-1103341-6
		29	HD.64.STO.1.29.G HD.64.STO.1.M32.G HD.64.STO.1.M40.G	1-1103344-6 0-1106470-1 3-1106470-0
Steckergehäuse: Kabeleingang oben, Hohe Bauform Hood: Top entry, High construction  	M50	36	HD.108.STO.1.36.G HD.108.STO.1.M50.G	1-1102414-6 0-1106467-1
		36	HD-K.108.STO.1.36.G HD-K.108.STO.1.M50.G	2-1102414-6 0-1106467-7
Anbaugehäuse: Kabeleingang unten, Standard Bauform Surface mounted housing: Bottom entry, Standard construction  			HB.24.AG-VS	1-1102291-1
			Mit Korrosionsschutz With corrosion protection HB-K.24.AG-VS	2-1102291-1

Passende Kabelverschraubungen ab Seite 188/Suitable Cable fittings from page 188

HB.24, HB-K.24, HD.64, HD-K.64 Gehäuse/Housings

Baugröße/Size 8

Pulverbeschichtet, silbergrau
 K = korrosionsgeschützt, schwarz

Powder-coated, silver-grey
K = corrosion-resistant, black

Verschlussbügel am Unterteil/Locking clip at housing bottom

IP 65

Bezeichnung Description	Metr.	PG	Bestelltext Designation	Bestell-Nr. Order No.
Sockelgehäuse: Kabeleingang seitlich, Standard Bauform <i>Surface mounted housing: Side entry, Standard construction</i> 	M25 2xM25	21 2x21	HB.24.SG-VS.1.21.Z HB.24.SG-VS.2.21.Z HB.24.SG-VS.1.M25.Z HB.24.SG-VS.2.M25.Z	1-1102331-1 1-1102333-1 0-1103061-1 0-1106464-4
		21 2x21	HB-K.24.SG-VS.1.21.Z HB-K.24.SG-VS.2.21.Z HB-K.24.SG-VS.2.M25.G	2-1102331-1 2-1102333-1 0-1106464-8
Sockelgehäuse: Kabeleingang seitlich, Hohe Bauform <i>Surface mounted housing: Side entry, High construction</i> 	M25 2xM32	21 2x21	HD.64.SG-VS.1.21.Z HD.64.SG-VS.2.21.Z	1-1103346-1 1-1103348-1
		29 2x29	HD.64.SG-VS.1.29.Z HD.64.SG-VS.2.29.Z HD.64.SG-VS.1.M25.G HD.64.SG-VS.2.M32.G	1-1103350-1 1-1103352-1 0-1103083-1 0-1106469-4
Kupplungsgehäuse: Kabeleingang unten, Hohe Bauform <i>Cable-to-cable hood: Bottom entry, High construction</i> 	M32	21 2x21	HD-K.64.SG-VS.1.21.Z HD-K.64.SG-VS.2.21.Z	2-1103346-1 2-1103348-1
		29 2x29	HD-K.64.SG-VS.1.29.Z HD-K.64.SG-VS.2.29.Z HD-K.64.SG-VS.2.M32.G	2-1103350-1 2-1103352-1 0-1106469-8
Kupplungsgehäuse: Kabeleingang unten, Hohe Bauform <i>Cable-to-cable hood: Bottom entry, High construction</i> 	M32	21 29	HD.64.KDO-VS.1.21.G HD.64.KDO-VS.1.29.G HD.64.KDO-VS.1.M32.G	1-1103355-1 1-1103358-1 0-1106468-2

Passende Kabelverschraubungen ab Seite 188/Suitable Cable fittings from page 188

HB.24, HB-K.24, HD.64, HD-K.64 Gehäuse/Housings

Baugröße/Size 8

Pulverbeschichtet, silbergrau
 K = korrosionsgeschützt, schwarz

Powder-coated, silver-grey
K = corrosion-resistant, black

Verschlussbügel am Oberteil/Locking clip on hood

IP 65

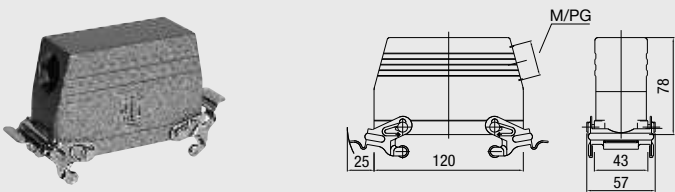
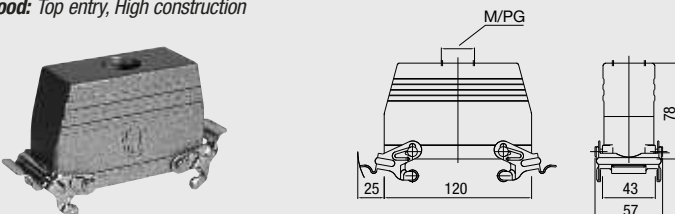
Bezeichnung Description	Metr.	PG	Bestelltext Designation	Bestell-Nr. Order No.
Steckergehäuse: Kabeleingang seitlich, Hohe Bauform Hood: Side entry, High construction 	M32	21	HD.64.STS-VS.1.21.G	1-1103336-1
		29	HD.64.STS-VS.1.29.G HD.64.STS-VS.1.M32.G	1-1103338-1 0-1106470-6
	Mit Korrosionsschutz With corrosion protection			
	M32	29	HD-K.64.STS-VS.1.29.G HD-K.64.STS-VS.1.M32.G	2-1103338-1 1-1106470-2
Steckergehäuse: Kabeleingang oben, Hohe Bauform Hood: Top entry, High construction 		M32	21	HD.64.STO-VS.1.21.G
	29		HD.64.STO-VS.1.29.G HD.64.STO-VS.1.M32.G	1-1103344-1 0-1106470-3
	Mit Korrosionsschutz With corrosion protection			
	M32	29	HD-K.64.STO-VS.1.29.G HD-K.64.STO-VS.1.M32.G	2-1103344-1 0-1106470-9

Passende Kabelverschraubungen ab Seite 188/Suitable Cable fittings from page 188

HB.24, HB-K.24, HD.64, HD-K.64 Gehäuse/Housings

Baugröße/Size 8

Pulverbeschichtet, silbergrau
 K = korrosionsgeschützt, schwarz

Powder-coated, silver-grey
K = corrosion-resistant, black

Verschlussbügel am Oberteil/Locking clip on hood

IP 65

Bezeichnung Description	Metr.	PG	Bestelltext Designation	Bestell-Nr. Order No.
<p>Anbaugehäuse: Kabeleingang unten, Standard Bauform <i>Surface mounted housing: Bottom entry, Standard construction</i></p>			HB.24.AGD Mit Korrosionsschutz <i>With corrosion protection</i> HB-K.24.AGD	1-1102340-6 2-1102340-6
<p>Sockelgehäuse: Kabeleingang seitlich, Standard Bauform <i>Surface mounted housing: Side entry, Standard construction</i></p>	M25 2xM25	21 2x21	HB.24.SGD.1.21.Z HB.24.SGD.2.21.Z HB.24.SGD.1.M25.Z HB.24.SGD.2.M25.Z Mit Korrosionsschutz <i>With corrosion protection</i>	1-1102343-6 1-1102345-6 0-1103061-2 0-1106464-1
<p>Sockelgehäuse: Kabeleingang seitlich, Hohe Bauform <i>Surface mounted housing: Side entry, High construction</i></p>	2xM32	21 2x21 29 2x29	HD.64.SGD.1.21.Z HD.64.SGD.2.21.Z HD.64.SGD.1.29.Z HD.64.SGD.2.29.Z HD.64.SGD.2.M32.Z Mit Korrosionsschutz <i>With corrosion protection</i>	1-1103360-6 1-1103362-6 1-1103364-6 1-1103366-6 0-1106469-1
	2xM32	29	HD-K.64.SGD.1.29.Z HD-K.64.SGD.2.M32.Z	2-1103364-6 0-1106469-5

Passende Kabelverschraubungen ab Seite 188/Suitable Cable fittings from page 188

HB/-K.24, HD/-K.64, HD/-K.108 Gehäuse/Housings

Baugröße/Size 8

Pulverbeschichtet, silbergrau
K = korrosionsgeschützt, schwarz

Powder-coated, silver-grey
K = corrosion-resistant, black

Längsbügel am Unterteil/Side clip at housing bottom

IP 65

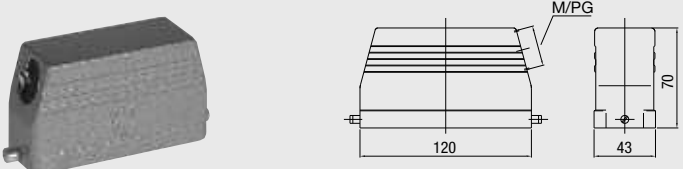
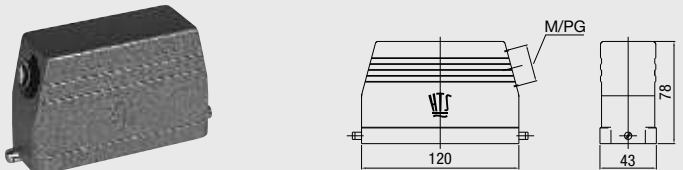
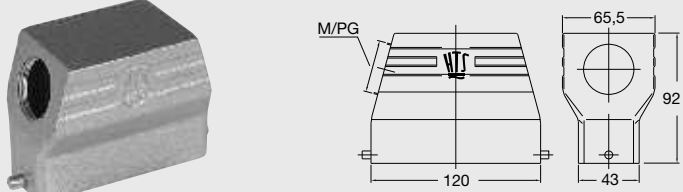
Bezeichnung Description	Metr.	PG	Bestelltext Designation	Bestell-Nr. Order No.
Steckergehäuse: Kabeleingang seitlich, Standard Bauform Hood: Side entry, Standard construction 	M32	21	HB.24.STS-GR.1.21.G	1-1102316-7
		29	HB.24.STS-GR.1.29.G HB.24.STS-GR.1.M32.G	1-1102319-7 0-1106465-5
	M32		Mit Korrosionsschutz With corrosion protection	
		21	HB-K.24.STS-GR.1.21.G	2-1102316-7
	M32	29	HB-K.24.STS-GR.1.29.G HB-K.24.STS-GR.1.M32.G	2-1102319-7 1-1106465-2
Steckergehäuse: Kabeleingang seitlich, Hohe Bauform Hood: Side entry, High construction 	M32 M40	21	HD.64.STS-GR.1.21.G	1-1103336-7
		29	HD.64.STS-GR.1.29.G HD.64.STS-GR.1.M32.G HD.64.STS-GR.1.M40.G	1-1103338-7 0-1106470-5 3-1106470-5
	M32		Mit Korrosionsschutz With corrosion protection	
		29	HD-K.64.STS-GR.1.29.G HD-K.64.STS-GR.1.M32.G	2-1103338-7 1-1106470-1
Steckergehäuse: Kabeleingang seitlich, Hohe Bauform Hood: Side entry, High construction 	M50	29	HD.108.STS-GR.1.29.G HD.108.STS-GR.1.M50.G	1-1102411-7 0-1106467-5
			Mit Korrosionsschutz With corrosion protection	
	M50	29	HD-K.108.STS-GR.1.29.G HD-K.108.STS-GR.1.M50.G	2-1102411-7 1-1106467-1

Passende Kabelverschraubungen ab Seite 188/Suitable Cable fittings from page 188

HB.24, HB-K.24, HD.64, HD-K.64 Gehäuse/Housings





Baugröße/Size 8

Pulverbeschichtet, silbergrau
 K = korrosionsgeschützt, schwarz

Powder-coated, silver-grey
K = corrosion-resistant, black

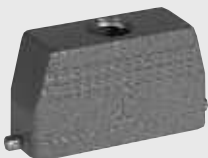
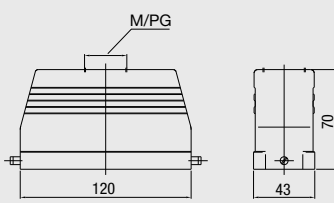
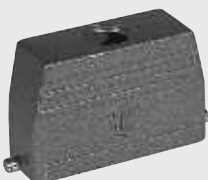
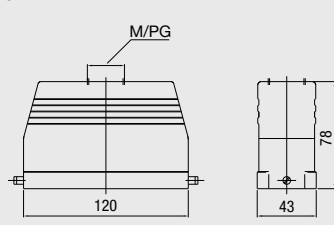
Längsbügel am Unterteil/Side clip at housing bottom

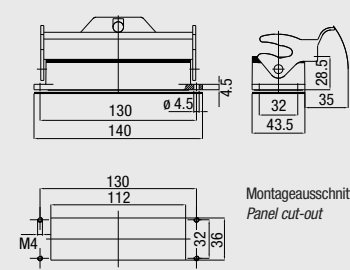
IP 65

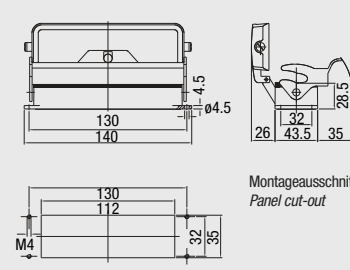
Bezeichnung Description	Metr.	PG	Bestelltext Designation	Bestell-Nr. Order No.
Steckergehäuse: Kabeleingang oben, Standard Bauform <i>Hood: Top entry, Standard construction</i>  	M32	21	HB.24.STO-GR.1.21.G	1-1102325-7
		29	HB.24.STO-GR.1.29.G HB.24.STO-GR.1.M32.G	1-1102328-7 0-1106465-2
Steckergehäuse: Kabeleingang oben, Hohe Bauform <i>Hood: Top entry, High construction</i>  	M32 M40	21	HD.64.STO-GR.1.21.G	1-1103341-7
		29	HD.64.STO-GR.1.29.G HD.64.STO-GR.1.M32.G HD.64.STO-GR.1.M40.G	1-1103344-7 0-1106470-2 2-1106470-5
Anbaugeschäuse: Kabeleingang unten, Standard Bauform <i>Surface mounted housing: Bottom entry, Standard construction</i>  	M32	29	HD-K.64.STO-GR.1.29.G HD-K.64.STO-GR.1.M32.G	2-1103344-7 0-1106470-8
		21	HB.24.AG-LB Mit Korrosionsschutz <i>With corrosion protection</i> HB-K.24.AG-LB	1-1102291-2 2-1102291-2
Anbaugeschäuse: Kabeleingang unten, Standard Bauform <i>Surface mounted housing: Bottom entry, Standard construction</i>  	M32	29	HB.24.AGD-LB Mit Korrosionsschutz <i>With corrosion protection</i> HB-K.24.AGD-LB	1-1102340-2 2-1102340-2
		21	HB.24.AG-LB Mit Korrosionsschutz <i>With corrosion protection</i> HB-K.24.AG-LB	1-1102291-2 2-1102291-2

Passende Kabelverschraubungen ab Seite 188/Suitable Cable fittings from page 188

HB.24, HB-K.24, HD.64, HD-K.64 Gehäuse/Housings











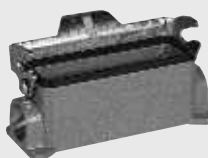
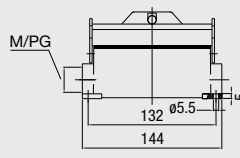
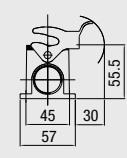

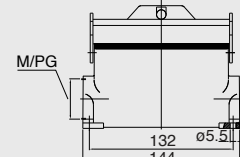
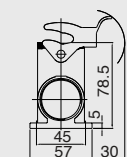

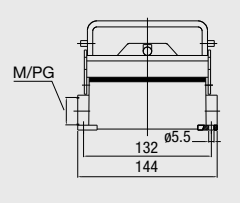
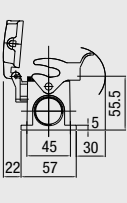

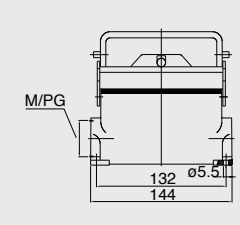
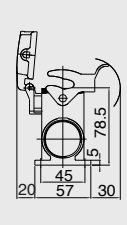
Baugröße/Size 8

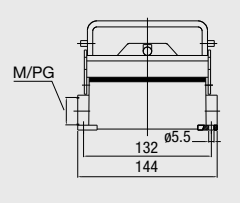
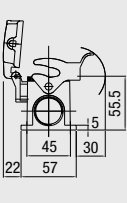
Pulverbeschichtet, silbergrau
 K = korrosionsgeschützt, schwarz

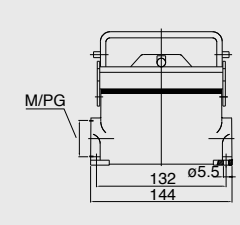
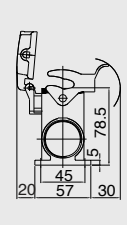
Powder-coated, silver-grey
K = corrosion-resistant, black

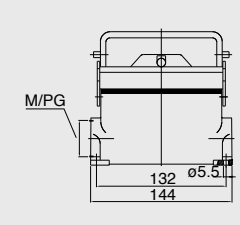
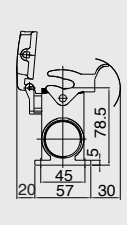
Längsbügel am Unterteil/Side clip at housing bottom

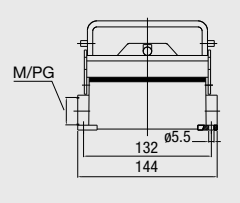
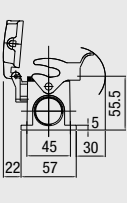
IP 65

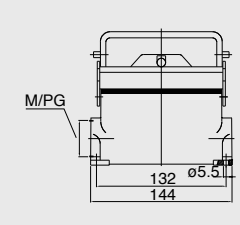
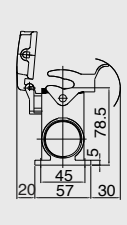
Bezeichnung Description	Metr.	PG	Bestelltext Designation	Bestell-Nr. Order No.
Sockelgehäuse: Kabeleingang seitlich, Standard Bauform <i>Surface mounted housing: Side entry, Standard construction</i>   	2xM25	21	HB.24.SG-LB.1.21.Z	1-1102331-2
		2x21	HB.24.SG-LB.2.21.Z HB.24.SG-LB.2.M25.G	1-1102333-2 0-1106464-3
Sockelgehäuse: Kabeleingang seitlich, Hohe Bauform <i>Surface mounted housing: Side entry, High construction</i>   	2xM32	21	HD.64.SG-LB.1.21.Z	1-1103346-2
		2x21	HD.64.SG-LB.2.21.Z	1-1103348-2
Sockelgehäuse: Kabeleingang seitlich, Standard Bauform <i>Surface mounted housing: Side entry, Standard construction</i>   	2xM25	29	HD.64.SG-LB.1.29.Z	1-1103350-2
		2x29	HD.64.SG-LB.2.29.Z HD.64.SG-LB.2.M32.Z	1-1103352-2 0-1106469-3
Sockelgehäuse: Kabeleingang seitlich, Hohe Bauform <i>Surface mounted housing: Side entry, High construction</i>   	2xM32	29	HD-K.64.SG-LB.1.29.Z	2-1103350-2
		2xM32	HD-K.64.SG-LB.2.M32.G	0-1106469-7
Sockelgehäuse: Kabeleingang seitlich, Standard Bauform <i>Surface mounted housing: Side entry, Standard construction</i>   	2xM25	21	HB.24.SGD-LB.1.21.Z	1-1102343-2
		2x21	HB.24.SGD-LB.2.21.Z HB.24.SGD-LB.1.M25.Z HB.24.SGD-LB.2.M25.Z	1-1102345-2 0-1103061-3 0-1106464-2
Sockelgehäuse: Kabeleingang seitlich, Hohe Bauform <i>Surface mounted housing: Side entry, High construction</i>   	2xM32	21	HB-K.24.SGD-LB.1.21.Z	2-1102343-2
		2xM25	HB-K.24.SGD-LB.2.M25.z	0-1106464-6
Sockelgehäuse: Kabeleingang seitlich, Hohe Bauform <i>Surface mounted housing: Side entry, High construction</i>   	2xM32	21	HD.64.SGD-LB.1.21.Z	1-1103360-2
		2x21	HD.64.SGD-LB.2.21.Z	1-1103362-2
Sockelgehäuse: Kabeleingang seitlich, Standard Bauform <i>Surface mounted housing: Side entry, Standard construction</i>   	2xM25	29	HD.64.SGD-LB.1.29.Z	1-1103364-2
		2x29	HD.64.SGD-LB.2.29.Z HD.64.SGD-LB.2.M32.Z	1-1103366-2 0-1106469-2
Sockelgehäuse: Kabeleingang seitlich, Hohe Bauform <i>Surface mounted housing: Side entry, High construction</i>   	2xM32	29	HD-K.64.SGD-LB.1.29.Z	2-1103364-2
		2xM32	HD-K.64.SGD-LB.2.M32.z	0-1106469-6

Passende Kabelverschraubungen ab Seite 188/Suitable Cable fittings from page 188

HB.24, HB-K.24, HD.64, HD-K.64 Gehäuse/Housings

Baugröße/Size 8

Pulverbeschichtet, silbergrau
 K = korrosionsgeschützt, schwarz

Powder-coated, silver-grey
K = corrosion-resistant, black

Längsbügel am Unterteil/Side clip at housing bottom

IP 65

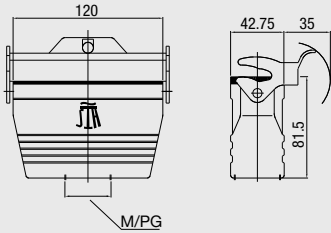
Bezeichnung Description	Metr.	PG	Bestelltext Designation	Bestell-Nr. Order No.
<p>Kupplungsgehäuse: Kabeleingang unten, Hohe Bauform <i>Cable-to-cable hood: Bottom entry, High construction</i></p>  	M32	21 29	HD.64.KDO-LB.1.21.G HD.64.KDO-LB.1.29.G HD.64.KDO-LB.1.M32.G	1-1103355-2 1-1103358-2 0-1106468-1

Passende Kabelverschraubungen ab Seite 188/Suitable Cable fittings from page 188

HB-Z.24, HB-K/Z.24, HD-Z.64, HD-K/Z.64 Gehäuse/Housings







Baugröße/Size 8

Pulverbeschichtet, silbergrau
 K = korrosionsgeschützt, schwarz

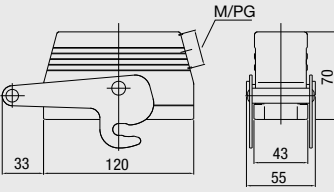
Powder-coated, silver-grey
K = corrosion-resistant, black

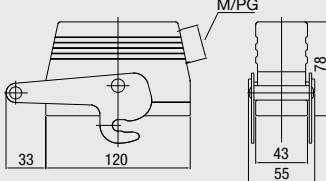
Zentralbügel am Steckergehäuse/Central locking clip on hood

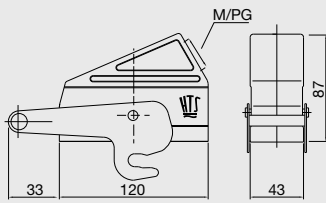
IP 65

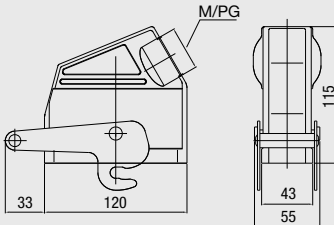
Bezeichnung Description	Metr.	PG	Bestelltext Designation	Bestell-Nr. Order No.	
Steckergehäuse: Kabeleingang seitlich, Standard Bauform Hood: Side entry, Standard construction  	M32	21	HB-Z.24.STS-ZB.1.21.G	1-1102316-3	
		29	HB-Z.24.STS-ZB.1.29.G	1-1102319-3	
			HB-Z.24.STS-ZB.1.M32.G	1-1106465-9	
				Mit Korrosionsschutz With corrosion protection	
	M32	29	HB-K/Z.24.STS-ZB.1.21.G	2-1102316-3	
			HB-K/Z.24.STS-ZB.1.M32.G	1-1106465-5	
Steckergehäuse: Kabeleingang seitlich, Hohe Bauform Hood: Side entry, High construction  	M32	21	HD-Z.64.STS-ZB.1.21.G	1-1103336-3	
		29	HD-Z.64.STS-ZB.1.29.G	1-1103338-3	
			HD-Z.64.STS-ZB.1.M32.G	1-1106470-8	
				Mit Korrosionsschutz With corrosion protection	
	M32	29	HD-K/Z.64.STS-ZB.1.29.G	2-1103338-3	
			HD-K/Z.64.STS-ZB.1.M32.G	1-1106470-6	
Steckergehäuse: Kabeleingang seitlich, Keilform Hood: Side entry, Standard construction  	M32	21	HB-KF-Z.24.STS-ZB.1.21.G	1-1102229-3	
		29	HB-KF-Z.24.STS-ZB.1.29.G	1-1102232-3	
			HB-KF-Z.24.STS-ZB.1.M32.G	0-1106466-8	
				Mit Korrosionsschutz With corrosion protection	
	M32	29	HB-KF/K-Z.24.STS-ZB.1.29.G	2-1102232-3	
			HB-KF/K-Z.24.STS-ZB.1.M32.G	0-1106466-7	
Steckergehäuse: Kabeleingang seitlich, Keilform Hood: Side entry, High construction  	M40	29	HD-KF-Z.64.STS-ZB.1.29.G	1-1102405-3	
		36	HD-KF-Z.64.STS-ZB.1.36.G	1-1102408-3	
			HD-KF-Z.64.STS-ZB.1.M40.G	0-1106471-9	
				Mit Korrosionsschutz With corrosion protection	
	M40	36	HD-KF/K-Z.64.STS-ZB.1.36.G	2-1102408-3	

Passende Kabelverschraubungen ab Seite 188/Suitable Cable fittings from page 188

HB-Z.24, HB-K/Z.24, HD-Z.64, HD-K/Z.64 Gehäuse/Housings





Baugröße/Size 8

Pulverbeschichtet, silbergrau
 K = korrosionsgeschützt, schwarz

Powder-coated, silver-grey
K = corrosion-resistant, black

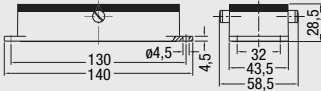
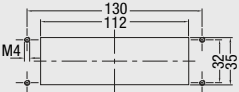
Zentralbügel am Steckergehäuse/Central locking clip on hood

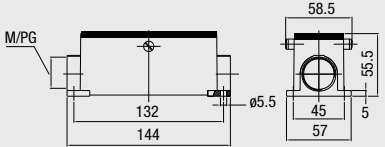
IP 65

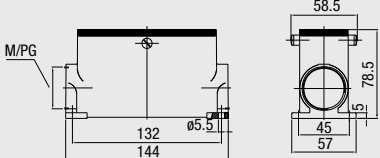
Bezeichnung Description	Metr.	PG	Bestelltext Designation	Bestell-Nr. Order No.
<p>Anbaugeschäuse: Kabeleingang unten, Standard Bauform <i>Surface mounted housing: Bottom entry, Standard construction</i></p>   <p>Montageausschnitt/Panel cut-out</p> 			<p>HB-Z.24.AG-ZVGR</p> <p>Mit Korrosionsschutz <i>With corrosion protection</i> HB-K/Z.24.AG-ZVGR</p>	<p>1-1102291-8</p> <p>2-1102291-8</p>
<p>Sockelgehäuse: Kabeleingang seitlich, Standard Bauform <i>Surface mounted housing: Side entry, Standard construction</i></p>  	2xM25	<p>21</p> <p>2x21</p>	<p>HB-Z.24.SG-ZVGR.1.21.Z</p> <p>HB-Z.24.SG-ZVGR.2.21.Z</p> <p>HB-Z.24.SG-ZVGR.2.M25.G</p> <p>Mit Korrosionsschutz <i>With corrosion protection</i> HB-K/Z.24.SG-ZVGR.1.21.Z</p>	<p>1-1102331-8</p> <p>1-1102333-8</p> <p>1-1106464-0</p> <p>2-1102331-8</p>
<p>Sockelgehäuse: Kabeleingang seitlich, Hohe Bauform <i>Surface mounted housing: Side entry, High construction</i></p>  	2xM32	<p>21</p> <p>29</p> <p>2x29</p>	<p>HD-Z.64.SG-ZVGR.1.21.Z</p> <p>HD-Z.64.SG-ZVGR.1.29.Z</p> <p>HD-Z.64.SG-ZVGR.2.29.Z</p> <p>HD-Z.64.SG-ZVGR.2.M32.G</p> <p>Mit Korrosionsschutz <i>With corrosion protection</i></p> <p>HD-K/Z.64.SG-ZVGR.1.29.Z</p> <p>HD-K/Z.64.SG-ZVGR.2.29.Z</p> <p>HD-K/Z.64.SG-ZVGR.2.M32.G</p>	<p>1-1103346-8</p> <p>1-1103350-8</p> <p>1-1103352-8</p> <p>1-1106469-2</p> <p>2-1103350-8</p> <p>2-1103352-8</p> <p>1-1106469-0</p>

Passende Kabelverschraubungen ab Seite 188/Suitable Cable fittings from page 188

HIP.24/64, HIP-K.24/64, EMV-K.24/64 Gehäuse/Housings

Baugröße/Size 8

HIP: Druckdicht, silbergrau, **HIP-K:** Korrosionsgeschützt, schwarz

EMV-K: Schutz gegen elektromagnetische Beeinflussung, druckdicht, korrosionsgeschützt, schwarz

HIP: Pressure-tight, silver-grey, **HIP-K:** Housings corrosion-resistant, black

EMV-K: Protection against electro-magnetic interference, pressure-tight, housings corrosion-resistant, black

Druckdicht bis ≤ 5 bar/pressure-tight up to 5 bar

IP 68

Bezeichnung Description	Metr.	PG	Bestelltext Designation	Bestell-Nr. Order No.	
<p>Steckergehäuse: Kabeleingang seitlich, Standard Bauform <i>Hood:</i> Side entry, Standard construction</p>	M40	21	HIP HIP.24/64.STS.1.21.G	1-1102658-5	
		29	HIP.24/64.STS.1.29.G	1-1102660-5	
			HIP.24/64.STS.1.M40.G	0-1106473-2	
	M40	29	HIP-K HIP-K.24/64.STS.1.29.G	2-1102660-5	
			HIP-K.24/64.STS.1.M40.G	0-1106473-4	
		29	EMV-K EMV-K.24/64.STS.1.29.G	4-1102755-5	
	M25		EMV-K.24/64.STS.1.M25.G	0-1102983-1	
		M32	EMV-K.24/64.STS.1.M32.G	0-1106461-8	
		M40	EMV-K.24/64.STS.1.M40.G	0-1106461-3	
	<p>Steckergehäuse: Kabeleingang seitlich, Keilform <i>Hood:</i> Side entry, Standard construction</p>	M40	29	HIP HIP-KF.24/64.STS.1.29.G	1-1102622-5
			36	HIP-KF.24/64.STS.1.36.G	1-1102623-5
				HIP-KF.24/64.STS.1.M40.G	0-1106474-1
M40		29	HIP-K HIP-KF/K.24/64.STS.1.29.G	2-1102622-5	
		36	HIP-KF/K.24/64.STS.1.36.G	2-1102623-5	
			HIP-KF/K.24/64.STS.1.M40.G	0-1106474-2	
M40		29	EMV-K EMV-KF/K.24/64.STS.1.29.G	4-1102732-5	
		36	EMV-KF/K.24/64.STS.1.36.G	4-1102733-5	
			EMV-KF/K.24/64.STS.1.M40.G	0-1106462-2	
<p>Steckergehäuse: Kabeleingang oben, Standard Bauform <i>Hood:</i> Top entry, Standard construction</p>		M40	21	HIP HIP.24/64.STO.1.21.G	1-1102662-5
			29	HIP.24/64.STO.1.29.G	1-1102664-5
				HIP.24/64.STO.1.M40.G	0-1106473-1
	2xM32 M40	29	HIP-K HIP-K.24/64.STO.1.29.G	2-1102664-5	
			HIP-K.24/64.STO.2.M32.G	0-1102792-1	
			HIP-K.24/64.STO.1.M40.G	0-1106473-3	
	M40	29	EMV-K EMV-K.24/64.STO.1.29.G	4-1102759-5	
			EMV-K.24/64.STO.1.M40.G	0-1106461-4	

Passende Kabelverschraubungen ab Seite 188/Suitable Cable fittings from page 188

HIP.24/64, HIP-K.24/64, EMV-K.24/64 Gehäuse/Housings

Baugröße/Size 8

HIP: Druckdicht, silbergrau, **HIP-K:** Korrosionsgeschützt, schwarz

EMV-K: Schutz gegen elektromagnetische Beeinflussung, druckdicht, korrosionsgeschützt, schwarz

HIP: Pressure-tight, silver-grey, **HIP-K:** Housings corrosion-resistant, black

EMV-K: Protection against electro-magnetic interference, pressure-tight, housings corrosion-resistant, black

Druckdicht bis ≤ 5 bar/pressure-tight up to 5 bar

IP 68

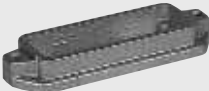
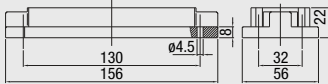
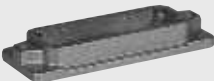
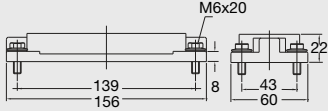
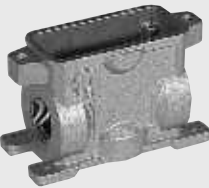
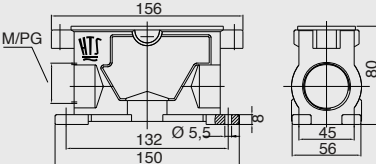
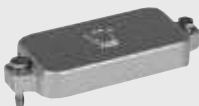
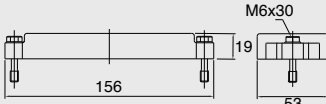
Bezeichnung Description	Metr.	PG	Bestelltext Designation	Bestell-Nr. Order No.
Anbaugehäuse: Kabeleingang unten, Standard Bauform <i>Surface mounted housing: Bottom entry, Standard construction</i>  			HIP HIP.24/64.AG	1-1102665-5
			HIP-K HIP-K.24/64.AG	2-1102665-5
			EMV-K EMV-K.24/64.AG	4-1102760-5
Anbaugehäuse: Kabeleingang unten, Standard Bauform <i>Surface mounted housing: Bottom entry, Standard construction</i>  			HIP HIP.24/64.AG.M6	1-1102626-5
			HIP-K HIP-K.24/64.AG.M6 HIP-K.24/64.AG.M6.D HIP-K-1.24/64.AG.M6.D	2-1102626-5 2-1102628-5 0-1108533-1
			EMV-K EMV-K.24/64.AG.M6	4-1102736-5
Sockelgehäuse: Kabeleingang seitlich, Standard Bauform <i>Surface mounted housing: Side entry, Standard construction</i>  	2xM40	29 2x29	HIP HIP.24/64.SG.1.29.G HIP.24/64.SG.2.29.G HIP.24/64.SG.2.M40.G	1-1102624-5 1-1102625-5 0-1106472-1
			HIP-K HIP-K.24/64.SG.1.29.G HIP-K.24/64.SG.2.29.G HIP-K.24/64.SG.2.M40.G	5-1102624-5 2-1102625-5 0-1106472-2
			EMV-K EMV-K.24/64.SG.1.29.G EMV-K.24/64.SG.2.29.G EMV-K.24/64.SG.2.M40.G	4-1102734-5 4-1102735-5 0-1106460-2
Schutzkappe für Gehäuse-Unterteile <i>Protective covers housings</i>  			HIP HIP/EMV.24/64.SKB	3-1106204-5
			HIP-K/EMV-K HIP-K/EMV-K.24/64.SKB	4-1106204-5

Passende Kabelverschraubungen ab Seite 188/Suitable Cable fittings from page 188

HA.48 Kontakteinsätze/Contact inserts

Baugröße/Size 9

Schraubanschluss, Federzug-Anschluss,
Crimpschluss für gedrehte HE/HA Crimpkontakte

**Kontaktzahlen
No. of contacts**

*Screw terminal, Spring Clamp terminal,
Crimp terminal for screw machined HE/HA crimp contacts*

(3 x 16) **48** +

250 V/16 A

Bezeichnung Description	Bestelltext Designation	Bestell-Nr./Order No.													
		Stifteinsatz Male insert	Buchseinsatz Female insert												
<p>Stifteinsatz/Male insert</p> <p>Schraubanschluss/Screw terminal</p>	<p>HA.16.Sti.S.B 1-16 HA.16.Sti.S.B 17-32 HA.16.Sti.S.B 33-48</p>	<p>1-1103416-1 1-1103416-7 1-1103416-8</p>													
<p>Buchseinsatz/Female insert</p>			<p>1-1103417-1 1-1103417-7 1-1103417-8</p>												
<p>Federzug-Anschluss/Spring Clamp terminal</p>	<p>HA.16.Sti.SC.B 1-16 HA.16.Sti.SC.B 17-32 HA.16.Sti.SC.B 33-48</p>	<p>7-1103416-1 7-1103416-7 7-1103416-8</p>													
<p>Buchseinsatz/Female insert</p>			<p>7-1103417-1 7-1103417-7 7-1103417-8</p>												
<p>Crimpschluss/Crimp terminal</p>	<p>HA.16.Sti.C.B 1-16 HA.16.Sti.C.B 17-32 HA.16.Sti.C.B 33-48</p>	<p>2-1103416-3 2-1103416-7 2-1103416-8</p>													
<p>Buchseinsatz/Female insert</p>	<p>HA.16.Bu.C.B 1-16 HA.16.Bu.C.B 17-32 HA.16.Bu.C.B 33-48</p>		<p>2-1103417-3 2-1103417-7 2-1103417-8</p>												
<p>Maße/Dimensions</p> <table border="1"> <tr> <td></td> <td>A</td> <td>B</td> <td>C</td> <td>D</td> <td>E</td> </tr> <tr> <td>mm</td> <td>77,5</td> <td>83,5</td> <td>33</td> <td>34</td> <td>35</td> </tr> </table>		A	B	C	D	E	mm	77,5	83,5	33	34	35			
	A	B	C	D	E										
mm	77,5	83,5	33	34	35										

Passende Crimpkontakte siehe Seite 37, Passende Crimpwerkzeuge siehe Seite 37
Suitable Crimp contacts see page 37, Suitable Crimping tools see page 37

Maßbild mm/Dimensions mm



*Abstand für sichere Kontaktgabe max. 21 mm

Anschlußseite Stift
Contact arrangement Male insert

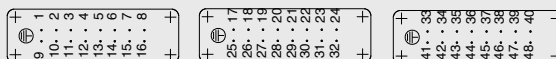

Anschlußseite Buchse
Contact arrangement Female insert

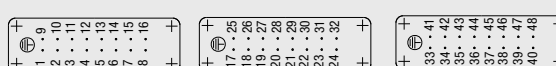

HA.48 Gehäuse/Housings

Baugröße/Size 9

Pulverbeschichtet, silbergrau

Powder-coated, silver-grey

Längsbügel am Unterteil/Side clip at housing bottom

IP 65

Bezeichnung Description	Metr.	PG	Bestelltext Designation	Bestell-Nr. Order No.
<p>Steckergehäuse: Kabeleingang seitlich, Standard Bauform <i>Hood:</i> Side entry, Standard construction</p>	M32	29	HA.48.STS-GR.1.29.G HA.48.STS-GR.1.M32.G	1-1102172-7 0-1102877-1
<p>Steckergehäuse: Kabeleingang oben, Standard Bauform <i>Hood:</i> Top entry, Standard construction</p>	M32	29	HA.48.STO-GR.1.29.G HA.48.STO-GR.1.M32.G	1-1102175-7 0-1102877-2
<p>Anbaugehäuse: Kabeleingang unten <i>Surface mounted housing:</i> Bottom en</p>	M32	29	HA.48.AG-LB	1-1102176-2
<p>Anbaugehäuse: Kabeleingang unten <i>Surface mounted housing with covers:</i> Bottom entry</p>	M32	29	HA.48.AGD-LB	1-1102177-2

Passende Kabelverschraubungen ab Seite 188/Suitable Cable fittings from page 188

HA.48 Gehäuse/Housings

Baugröße/Size 9

Pulverbeschichtet, silbergrau

Powder-coated, silver-grey

Längsbügel am Unterteil/Side clip at housing bottom

IP 65

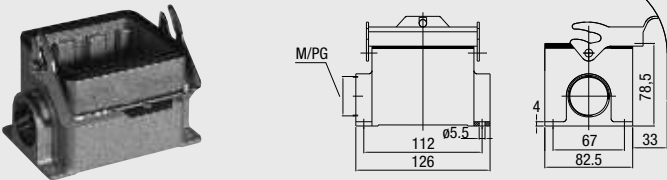
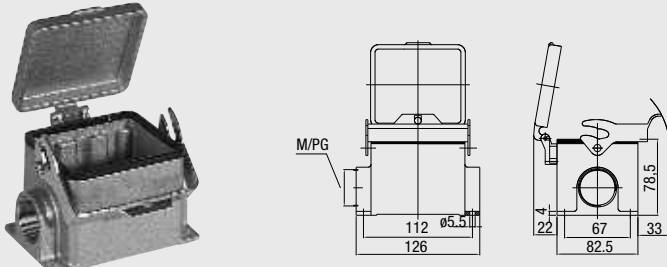
Bezeichnung Description	Metr.	PG	Bestelltext Designation	Bestell-Nr. Order No.
<p>Sockelgehäuse: Kabeleingang seitlich, Standard Bauform <i>Surface mounted housing: Side entry, Standard construction</i></p> 		29 2x29	HA.48.SG-LB.1.29.Z HA.48.SG-LB.2.29.Z	1-1102179-2 1-1102181-2
<p>Sockelgehäuse: Kabeleingang seitlich, Standard Bauform <i>Surface mounted housing: Side entry, Standard construction</i></p> 	M32 2xM32	29 2x29	HA.48.SGD-LB.1.29.Z HA.48.SGD-LB.2.29.Z HA.48.SGD-LB.1.M32.G HA.48.SGD-LB.2.M32.G	1-1102183-2 1-1102185-2 0-1102879-1 0-1102879-2

Passende Kabelverschraubungen ab Seite 188/Suitable Cable fittings from page 188

HE.32 Kontakteinsätze/Contact inserts

Baugröße/Size 10

Schraubanschluss, Federzug-Anschluss,
Crimpanschluss für gedrehte HE Crimpkontakte

**Kontaktzahlen
No. of contacts**

*Screw terminal, Spring Clamp terminal,
Crimp terminal for screw machined HE crimp contacts*

(2 x 16) **32 +**

400 V/16 A

Bezeichnung Description	Bestelltext Designation	Bestell-Nr./Order No.													
		Stifteinsatz Male insert	Buchseinsatz Female insert												
<p>Stifteinsatz/Male insert</p> <p>Schraubanschluss/Screw terminal</p>	<p>HE.16.Sti.S.B 1-16 HE.16.Sti.S.B 17-32</p>	<p>1-1103638-1 1-1103638-9</p>													
<p>Buchseinsatz/Female insert</p>	<p>HE.16.Bu.S.B 1-16 HE.16.Bu.S.B 17-32</p>		<p>1-1103639-1 1-1103639-9</p>												
<p>Federzug-Anschluss/Spring Clamp terminal</p>	<p>HE.16.STI.SC.B. 1-16 HE.16.STI.SC.B.17-32</p>	<p>7-1103638-1 7-1103638-9</p>													
<p>Buchseinsatz/Female insert</p>	<p>HE.16.BU.SC.B. 1-16 HE.16.BU.SC.B.17-32</p>		<p>7-1103639-1 7-1103639-9</p>												
<p>Crimpanschluss/Crimp terminal</p>	<p>HE.16.Sti.C.B 1-16 HE.16.Sti.C.B 17-32</p>	<p>2-1103638-3 2-1103638-9</p>													
<p>Buchseinsatz/Female insert</p>	<p>HE.16.Bu.C.B 1-16 HE.16.Bu.C.B 17-32</p>		<p>2-1103639-3 2-1103639-9</p>												
<p>Maße/Dimensions</p> <table border="1"> <tr> <td></td> <td>A</td> <td>B</td> <td>C</td> <td>D</td> <td>E</td> </tr> <tr> <td>mm</td> <td>77,5</td> <td>83,5</td> <td>33</td> <td>34</td> <td>35</td> </tr> </table>		A	B	C	D	E	mm	77,5	83,5	33	34	35			
	A	B	C	D	E										
mm	77,5	83,5	33	34	35										

Passende Crimpkontakte siehe Seite 37, Passende Crimpwerkzeuge siehe Seite 37
Suitable Crimp contacts see page 37, Suitable Crimping tools see page 37

Maßbild mm
Dimensions mm

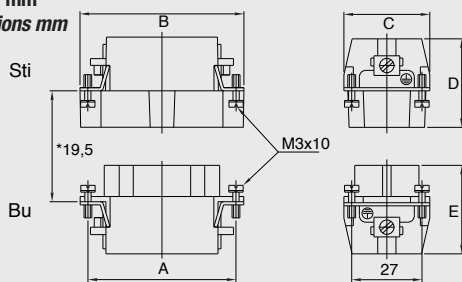

Anschlußseite Stift
Contact arrangement Male insert



Anschlußseite Buchse
Contact arrangement Female insert



HSB.12/35 Kontakteinsätze/Contact inserts

Baugröße/Size 10



Schraubanschluss

**Kontaktzahlen
No. of contacts**

Screw terminal

(2 x 6) **12 +**

400 V/35 A

Bezeichnung Description	Bestelltext Designation	Bestell-Nr./Order No.	
		Stifteinsatz Male insert	Buchseinsatz Female insert
<p>Stifteinsatz/Male insert</p> <p>Schraubanschluss/Screw terminal</p> 	<p>HSB.6/35.Sti.S 1-6 HSB.6/35.Sti.S 7-12</p>	<p>1-1104204-1 1-1104206-1</p>	
<p>Buchseinsatz/Female insert</p> 	<p>HSB.6/35.Bu.S 1-6 HSB.6/35.Bu.S 7-12</p>		<p>1-1104205-1 1-1104207-1</p>

Maße/Dimensions	A	B	C	D	E
mm	77,5	83,5	33	33	33,5

**Maßbild mm
Dimensions mm**

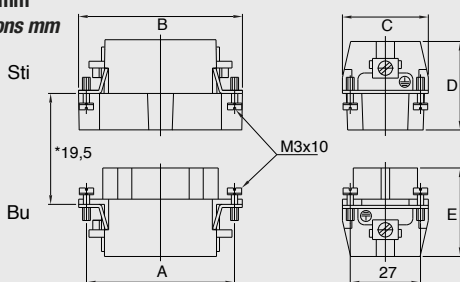

**Anschlußseite Stift
Contact arrangement Male insert**



**Anschlußseite Buchse
Contact arrangement Female insert**



*Abstand für sichere Kontaktgabe max. 21 mm

HN.D.80/HN.2D.144 Kontakteinsätze/Contact inserts

Baugröße/Size 10

Crimpanschluss für gedrehte HN.D Crimpkontakte

Kontaktzahlen

No. of contacts

Crimp terminal for screw machined HN.D crimp contacts

(2 x 40/2 x 72) 80/144 +

250 V/10 A

Bezeichnung Description	Bestelltext Designation	Bestell-Nr./Order No.	
		Stifteinsatz Male insert	Buchseinsatz Female insert
<p>Stifteinsatz/Male insert</p> <p>Crimpanschluss/Crimp terminal</p>	2xHN.D.40.Sti.C	2-1103110-3	
<p>Buchseinsatz/Female insert</p>	2xHN.D.40.BU.C		2-1103111-3
<p>Crimpanschluss/Crimp terminal</p>	HN.2D.72.Sti.C.B 1-72 HN.2D.72.Sti.C.B 73-144	2-1103208-3 2-1103209-3	
<p>Crimpanschluss/Crimp terminal</p>	HN.2D.72.Bu.C.B 1-72 HN.2D.72.Bu.C.B 73-144		2-1103212-3 2-1103213-3

HN.D.80

Maße/Dimensions	A	B	C	D	E
mm	77,5	84,5	33	35	35

HN.2D.144

Maße/Dimensions	A	B	C	D	E
mm	77,5	83,5	34	36,5	37

Passende Crimpkontakte siehe Seite 34, Passende Crimpwerkzeuge siehe Seite 34
Suitable Crimp contacts see page 34, Suitable Crimping tools see page 34

Maßbild mm/Dimensions mm

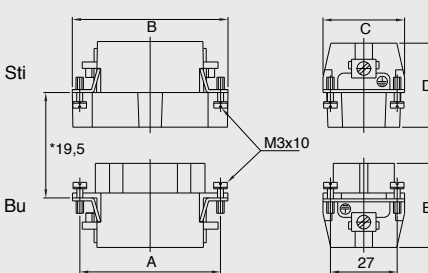

Anschlußseite Stift/Contact arrangement Male insert

HN.D.80

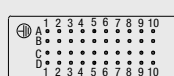
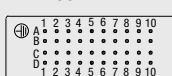

HN.2D.144

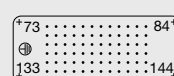

Anschlußseite Buchse/Contact arrangement Female insert

HN.D.80

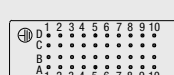
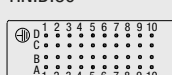

HN.2D.144

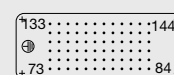
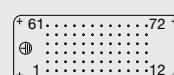

*Abstand für sichere Kontaktgabe max. 21 mm

HD.80 Kontakteinsätze/Contact inserts

Baugröße/Size 10



Crimpschluss für gestanzte HD.M Crimpkontakte

**Kontaktzahlen
No. of contacts**

Crimp terminal for stamped HD.M crimp contacts

(2 x 40) **80 +**

250 V/10 A

Bezeichnung Description	Bestelltext Designation	Bestell-Nr./Order No.	
		Stifteinsatz Male insert	Buchseinsatz Female insert
<p>Stifteinsatz/Male insert</p> <p>Schraubanschluss/Screw terminal</p> 	2xHD.40.Sti.C	2-1103012-3	
<p>Buchseinsatz/Female insert</p> 	2xHD.40.Bu.C		2-1103013-3

Maße/Dimensions	A	B	C	D	E
mm	77,5	84,5	33	35	35

Passende Crimpkontakte siehe Seite 35, Passende Crimpwerkzeuge siehe Seite 35
 Suitable Crimp contacts see page 35, Suitable Crimping tools see page 35

Maßbild mm
 Dimensions mm

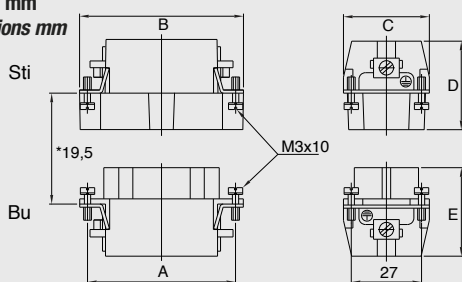

Anschlußseite Stift
 Contact arrangement Male insert



Anschlußseite Buchse
 Contact arrangement Female insert



*Abstand für sichere Kontaktgabe max. 21 mm

Modul Halterahmen/Module Fixing Frame

Baugröße/Size 10

Bezeichnung
Description

Bestelltext
Designation

Bestell-Nr./Order No.
Oberteil
Top part **Unterteil**
Bottom part

Halterahmen/*Fixing frame*

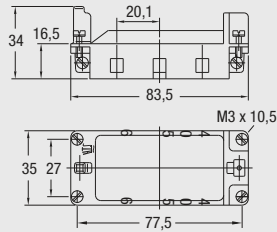

MDL2-GR.0-6/B.1-3
MDL2-GR.0-6/B.4-6

0-1108782-1
0-1108782-4

Für Modul MDL Seite 194–203
For module MDL page 194–203

Montageausschnitt/*Panel cut-out*

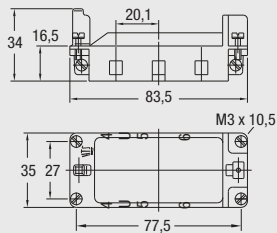
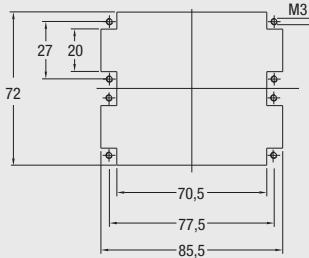

MDL2-GR.U-6/B.1-3
MDL2-GR.U-6/B.4-6

0-1108782-2
0-1108782-5

Für Modul MDL Seite 194–203
For module MDL page 194–203

Halterahmen/*Fixing frame*

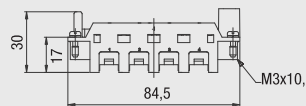

HVS-R.O 1-4
HVS-R.U 1-4

0-1103250-3

0-1103250-4

Für Modul HVS Seite 204–212
For module HVS page 204–212

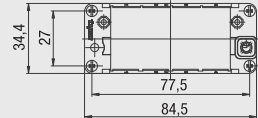

Montageausschnitt/*Panel cut-out*

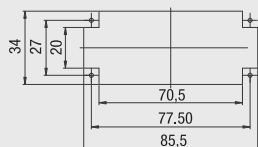

HB.32, HB-K.32 Gehäuse/Housings

Baugröße/Size 10

Pulverbeschichtet, silbergrau
 K = korrosionsgeschützt, schwarz

Powder-coated, silver-grey
K = corrosion-resistant, black

Verschlussbügel am Unterteil/Locking clip at housing bottom

IP 65

Bezeichnung Description	Metr.	PG	Bestelltext Designation	Bestell-Nr. Order No.
<p>Steckergehäuse: Kabeleingang seitlich, Standard Bauform <i>Hood: Side entry, Standard construction</i></p>	M40	29	HB.32.STS.1.29.G HB.32.STS.1.M40.G Mit Korrosionsschutz With corrosion protection	1-1102348-6 0-1106477-4
<p>Steckergehäuse: Kabeleingang oben, Standard Bauform <i>Hood: Top entry, Standard construction</i></p>	M40	29	HB.32.STO.1.29.G HB.32.STO.1.M40.G Mit Korrosionsschutz With corrosion protection	1-1102351-6 0-1106477-1
<p>Anbaugeschäuse: Kabeleingang unten, Standard Bauform <i>Surface mounted housing: Bottom entry, Standard construction</i></p>	M40	29	HB.32.AG-VS Mit Korrosionsschutz With corrosion protection	1-1102352-1
			HB-K.32.AG-VS	2-1102352-1

Passende Kabelverschraubungen ab Seite 188/Suitable Cable fittings from page 188

HB.32, HB-K.32 Gehäuse/Housings

Baugröße/Size 10

Pulverbeschichtet, silbergrau
 K = korrosionsgeschützt, schwarz

Powder-coated, silver-grey
K = corrosion-resistant, black

Verschlussbügel am Unterteil/Locking clip at housing bottom

IP 65

Bezeichnung Description	Metr.	PG	Bestelltext Designation	Bestell-Nr. Order No.
<p>Sockelgehäuse: Kabeleingang seitlich, Standard Bauform <i>Surface mounted housing: Side entry, Standard construction</i></p>	2xM32	29 2x29	HB.32.SG-VS.1.29.Z HB.32.SG-VS.2.29.Z HB.32.SG-VS.2.M32.Z Mit Korrosionsschutz <i>With corrosion protection</i>	1-1102354-1 1-1102356-1 0-1106476-4
<p>Kupplungsgehäuse: Kabeleingang unten, Standard Bauform <i>Cable-to-cable hood: Bottom entry, Standard construction</i></p>	M40	29	HB.32.KDO-VS.1.29.G HB.32.KDO-VS.1.M40.G	1-1102359-1 0-1106475-2

Passende Kabelverschraubungen ab Seite 188/Suitable Cable fittings from page 188

HB.32, HB-K.32 Gehäuse/Housings

Baugröße/Size 10

Pulverbeschichtet, silbergrau
K = korrosionsgeschützt, schwarz

Powder-coated, silver-grey
K = corrosion-resistant, black

Verschlussbügel am Oberteil/Locking clip on hood

IP 65

Bezeichnung Description	Metr.	PG	Bestelltext Designation	Bestell-Nr. Order No.
<p>Steckergehäuse: Kabeleingang seitlich, Standard Bauform Hood: Side entry, Standard construction</p>	M40	29	HB.32.STS-VS.1.29.G HB.32.STS-VS.1.M40.G	1-1102348-1 0-1106477-6
	M40		Mit Korrosionsschutz With corrosion protection HB-K.32.STS-VS.1.M40.G	1-1106477-2
<p>Anbaugeschäuse: Kabeleingang unten, Standard Bauform Surface mounted housing: Bottom entry, Standard construction</p>			HB.32.AGD	1-1102360-6
			Mit Korrosionsschutz With corrosion protection HB-K.32.AGD	2-1102360-6
<p>Sockelgehäuse: Kabeleingang seitlich, Standard Bauform Surface mounted housing: Side entry, Standard construction</p>	2xM32	29 2x29	HB.32.SGD.1.29.Z HB.32.SGD.2.29.Z HB.32.SGD.2.M32.Z	1-1102362-6 1-1102364-6 0-1106476-1
	2xM32		Mit Korrosionsschutz With corrosion protection HB-K.32.SGD.2.M32.Z	0-1106476-5

Passende Kabelverschraubungen ab Seite 188/Suitable Cable fittings from page 188

HB.32, HB-K.32 Gehäuse/Housings

Baugröße/Size 10

Pulverbeschichtet, silbergrau
K = korrosionsgeschützt, schwarz

Powder-coated, silver-grey
K = corrosion-resistant, black

Längsbügel am Unterteil/Side clip at housing bottom

IP 65

Bezeichnung Description	Metr.	PG	Bestelltext Designation	Bestell-Nr. Order No.
<p>Steckergehäuse: Kabeleingang seitlich, Standard Bauform Hood: Side entry, Standard construction</p>	M40	29	HB.32.STS-GR.1.29.G HB.32.STS-GR.1.M40.G Mit Korrosionsschutz With corrosion protection	1-1102348-7 0-1106477-5
	M40	29	HB-K.32.STS-GR.1.29.G HB-K.32.STS-GR.1.M40.G	2-1102348-7 1-1106477-1
<p>Steckergehäuse: Kabeleingang oben, Standard Bauform Hood: Top entry, Standard construction</p>	M40	29	HB.32.STO-GR.1.29.G HB.32.STO-GR.1.M40.G Mit Korrosionsschutz With corrosion protection	1-1102351-7 0-1106477-2
	M40	29	HB-K.32.STO-GR.1.29.G HB-K.32.STO-GR.1.M40.G	2-1102351-7 0-1106477-8

Passende Kabelverschraubungen ab Seite 188/Suitable Cable fittings from page 188

HB.16, HB-K.16 Gehäuse/Housings

Baugröße/Size 10

Pulverbeschichtet, silbergrau
 K = korrosionsgeschützt, schwarz

Powder-coated, silver-grey
K = corrosion-resistant, black

Verschlussbügel am Unterteil/Locking clip at housing bottom

IP 65

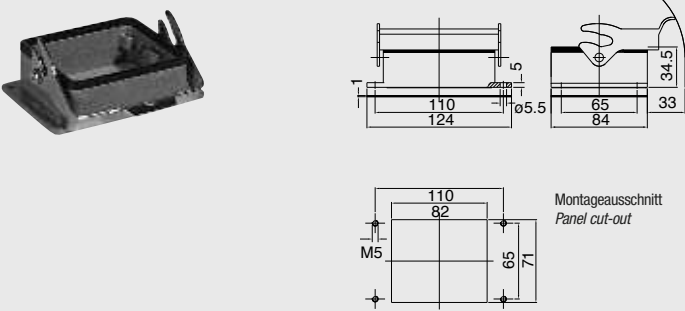
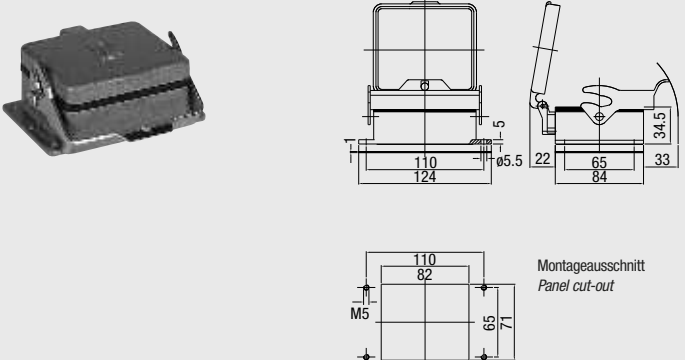
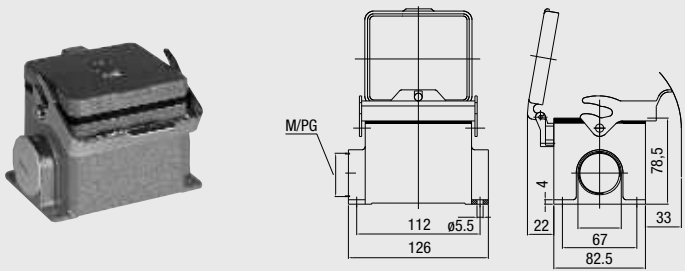
Bezeichnung Description	Metr.	PG	Bestelltext Designation	Bestell-Nr. Order No.
<p>Anbaugehäuse: Kabeleingang unten, Standard Bauform <i>Surface mounted housing: Bottom entry, Standard construction</i></p> 			<p>HB.32.AG-LB Mit Korrosionsschutz <i>With corrosion protection</i> HB-K.32.AG-LB</p>	<p>1-1102352-2 2-1102352-2</p>
<p>Anbaugehäuse: Kabeleingang unten, Standard Bauform <i>Surface mounted housing: Bottom entry, Standard construction</i></p> 			<p>HB.32.AGD-LB Mit Korrosionsschutz <i>With corrosion protection</i> HB-K.32.AGD-LB</p>	<p>1-1102360-2 2-1102360-2</p>
<p>Sockelgehäuse: Kabeleingang seitlich, Standard Bauform <i>Surface mounted housing: Side entry, Standard construction</i></p> 	<p>2xM32</p>	<p>29</p>	<p>HB.32.SGD-LB.1.29.Z HB.32.SGD-LB.2.M32.Z</p>	<p>1-1102362-2 0-1106476-2</p>

Passende Kabelverschraubungen ab Seite 188/Suitable Cable fittings from page 188

HB-Z.32, HB-K/Z.32 Gehäuse/Housings

Baugröße/Size 10

Pulverbeschichtet, silbergrau
 K = korrosionsgeschützt, schwarz

Powder-coated, silver-grey
K = corrosion-resistant, black

Zentralbügel am Steckergehäuse/Central locking clip on hood

IP 65

Bezeichnung Description	Metr.	PG	Bestelltext Designation	Bestell-Nr. Order No.
Steckergehäuse: Kabeleingang seitlich, Standard Bauform Hood: Side entry, Standard construction	M40	29	HB-Z.32.STS-ZB.1.29.G HB-Z.32.STS-ZB.1.M40.G	1-1102348-3 1-1106477-6
				Mit Korrosionsschutz With corrosion protection
Anbaugehäuse: Kabeleingang unten, Standard Bauform Surface mounted housing: Bottom entry, Standard construction	M40	29	HB-Z.32.AG-ZVGR	1-1102352-8
			<p>Montageausschnitt Panel cut-out</p>	Mit Korrosionsschutz With corrosion protection
Sockelgehäuse: Kabeleingang seitlich, Standard Bauform Surface mounted housing: Side entry, Standard construction	M40	29 2x29	HB-Z.32.SG-ZVGR.1.29.Z HB-Z.32.SG-ZVGR.2.29.Z	1-1102354-8 1-1102356-8
				Mit Korrosionsschutz With corrosion protection

Passende Kabelverschraubungen ab Seite 188/Suitable Cable fittings from page 188

HA.64 Kontakteinsätze/Contact inserts

Baugröße/Size 11





Schraubanschluss, Federzug-Anschluss,
Crimpanschluss für gedrehte HE Crimpkontakte

**Kontaktzahlen
No. of contacts**

*Screw terminal, Spring Clamp terminal,
Crimp terminal for screw machined HE crimp contacts*

(4 x 16) **64** +

250 V/16 A

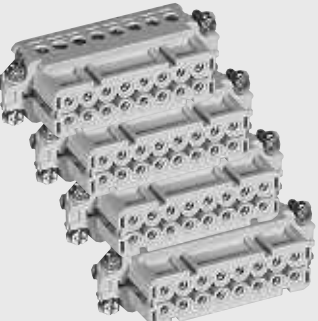
Bezeichnung Description	Bestelltext Designation	Bestell-Nr./Order No.													
		Stifteinsatz Male insert	Buchseinsatz Female insert												
<p>Stifteinsatz/Male insert</p> <p>Schraubanschluss/Screw terminal</p> 	<p>HA.16.Sti.S.B 1-16</p> <p>HA.16.Sti.S.B 17-32</p> <p>HA.16.Sti.S.B 33-48</p> <p>HA.16.Sti.S.B 49-64</p>	<p>1-1103416-1</p> <p>1-1103416-7</p> <p>1-1103416-8</p> <p>1-1103416-9</p>													
<p>Buchseinsatz/Female insert</p> 	<p>HA.16.Bu.S.B 1-16</p> <p>HA.16.Bu.S.B 17-32</p> <p>HA.16.Bu.S.B 33-48</p> <p>HA.16.Bu.S.B 49-64</p>		<p>1-1103417-1</p> <p>1-1103417-7</p> <p>1-1103417-8</p> <p>1-1103417-9</p>												
<p>Federzug-Anschluss/Spring Clamp terminal</p> 	<p>HA.16.Sti.SC.B 1-16</p> <p>HA.16.Sti.SC.B 17-32</p> <p>HA.16.Sti.SC.B 33-48</p> <p>HA.16.Sti.SC.B 49-64</p>	<p>7-1103416-1</p> <p>7-1103416-7</p> <p>7-1103416-8</p> <p>7-1103416-9</p>													
<p>Buchseinsatz/Female insert</p> 	<p>HA.16.Bu.SC.B 1-16</p> <p>HA.16.Bu.SC.B 17-32</p> <p>HA.16.Bu.SC.B 33-48</p> <p>HA.16.Bu.SC.B 49-64</p>		<p>7-1103417-1</p> <p>7-1103417-7</p> <p>7-1103417-8</p> <p>7-1103417-9</p>												
<p>Crimpanschluss/Crimp terminal</p> 	<p>HA.16.Sti.C.B 1-16</p> <p>HA.16.Sti.C.B 17-32</p> <p>HA.16.Sti.C.B 33-48</p> <p>HA.16.Sti.C.B 49-64</p>	<p>2-1103416-3</p> <p>2-1103416-7</p> <p>2-1103416-8</p> <p>2-1103416-9</p>													
<p>Buchseinsatz/Female insert</p> 	<p>HA.16.Bu.C.B 1-16</p> <p>HA.16.Bu.C.B 17-32</p> <p>HA.16.Bu.C.B 33-48</p> <p>HA.16.Bu.C.B 49-64</p>		<p>2-1103417-3</p> <p>2-1103417-7</p> <p>2-1103417-8</p> <p>2-1103417-9</p>												
<p>Maße/Dimensions</p> <table border="1"> <tr> <td></td> <td>A</td> <td>B</td> <td>C</td> <td>D</td> <td>E</td> </tr> <tr> <td>mm</td> <td>77,5</td> <td>83,5</td> <td>33</td> <td>34</td> <td>35</td> </tr> </table>		A	B	C	D	E	mm	77,5	83,5	33	34	35			
	A	B	C	D	E										
mm	77,5	83,5	33	34	35										

Passende Crimpkontakte siehe Seite 37, Passende Crimpwerkzeuge siehe Seite 37
Suitable Crimp contacts see page 37, Suitable Crimping tools see page 37

Maßbild mm/Dimensions mm

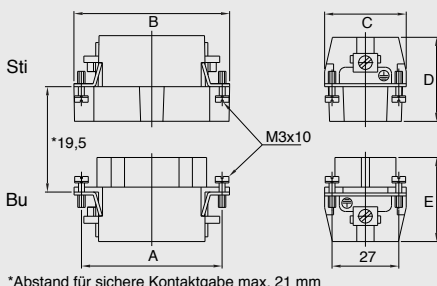

*Abstand für sichere Kontaktgabe max. 21 mm

Anschlußseite Stift/Contact arrangement Male insert



Anschlußseite Buchse/Contact arrangement Female insert

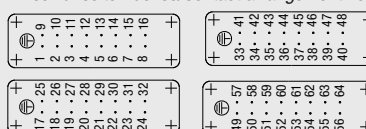

HA.64 Gehäuse/Housings

Baugröße/Size 11

Pulverbeschichtet, silbergrau

Powder-coated, silver-grey

Längsbügel am Unterteil/Side clip at housing bottom

IP 65

Bezeichnung Description	Metr.	PG	Bestelltext Designation	Bestell-Nr. Order No.
<p>Steckergehäuse: Kabeleingang seitlich, Standard Bauform <i>Hood: Side entry, Standard construction</i></p>	M50	29 36 42	HA.64.STS-GR.1.29.G HA.64.STS-GR.1.36.G HA.64.STS-GR.1.42.G HA.64.STS-GR.1.M50.G	1-1102002-7 1-1102005-7 1-1102008-7 0-1106480-2
<p>Steckergehäuse: Kabeleingang oben, Standard Bauform <i>Hood: Top entry, Standard construction</i></p>	M50	29 36 42	HA.64.STO-GR.1.29.G HA.64.STO-GR.1.36.G HA.64.STO-GR.1.42.G HA.64.STO-GR.1.M50.G	1-1102027-7 1-1102030-7 1-1102033-7 0-1106480-1
<p>Anbaugehäuse: Kabeleingang unten, Standard Bauform <i>Surface mounted housing: Bottom entry, Standard construction</i></p>			HA.64.AGD-LB	1-1102009-2
<p>Sockelgehäuse: Kabeleingang seitlich, Standard Bauform <i>Surface mounted housing: Side entry, Standard construction</i></p>	2xM40	29 2x29 36 2x36	HA.64.SGD-LB.1.29.Z HA.64.SGD-LB.2.29.Z HA.64.SGD-LB.1.36.Z HA.64.SGD-LB.2.36.Z HA.64.SGD-LB.2.M40.Z	1-1102011-2 1-1102013-2 1-1102015-2 1-1102017-2 01106479-1

Passende Kabelverschraubungen ab Seite 188/Suitable Cable fittings from page 188

HE.48 Kontakteinsätze/Contact inserts

Baugröße/Size 12

Schraubanschluss, Federzug-Anschluss,
Crimpanschluss für gedrehte HE Crimpkontakte

**Kontaktzahlen
No. of contacts**

*Screw terminal, Spring Clamp terminal,
Crimp terminal for screw machined HE crimp contacts*

(2 x 24) **48+**

400 V/16 A

Bezeichnung Description	Bestelltext Designation	Bestell-Nr./Order No.													
		Stifteinsatz Male insert	Buchseinsatz Female insert												
<p>Stifteinsatz/Male insert</p> <p>Schraubanschluss/Screw terminal</p>	<p>HE.24.Sti.S.B 1-24 HE.24.Sti.S.B 25-48</p>	<p>1-1103640-1 1-1103640-9</p>													
<p>Buchseinsatz/Female insert</p>	<p>HE.24.Bu.S.B 1-24 HE.24.Bu.S.B 25-48</p>		<p>1-1103641-1 1-1103641-9</p>												
<p>Federzug-Anschluss/Spring Clamp terminal</p>	<p>HE.24.Sti.SC.B 1-24 HE.24.Sti.SC.B 25-48</p>	<p>7-1103640-1 7-1103640-9</p>													
<p>Buchseinsatz/Female insert</p>	<p>HE.24.Bu.SC.B 1-24 HE.24.Bu.SC.B 25-48</p>		<p>7-1103641-1 7-1103641-9</p>												
<p>Crimpanschluss/Crimp terminal</p>	<p>HE.24.Sti.C.B 1-24 HE.24.Sti.C.B 25-48</p>	<p>2-1103640-3 2-1103640-9</p>													
<p>Buchseinsatz/Female insert</p>	<p>HE.24.Bu.C.B 1-24 HE.24.Bu.C.B 25-48</p>		<p>2-1103641-3 2-1103641-9</p>												
<p>Maße/Dimensions</p> <table border="1"> <tr> <td></td> <td>A</td> <td>B</td> <td>C</td> <td>D</td> <td>E</td> </tr> <tr> <td>mm</td> <td>104</td> <td>110</td> <td>33</td> <td>34</td> <td>35</td> </tr> </table>		A	B	C	D	E	mm	104	110	33	34	35			
	A	B	C	D	E										
mm	104	110	33	34	35										

Passende Crimpkontakte siehe Seite 37, Passende Crimpwerkzeuge siehe Seite 37
Suitable Crimp contacts see page 37, Suitable Crimping tools see page 37

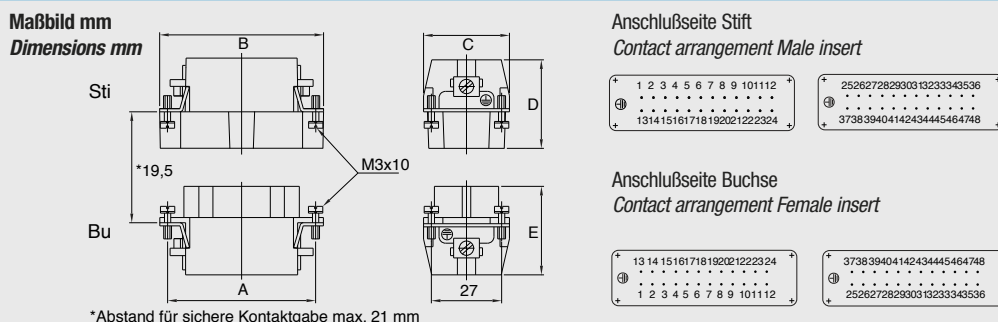

HN.D.128/HN.2D.216 Kontakteinsätze/Contact inserts

Baugröße/Size 12

Crimpanschluss für gedrehte HN.D Crimpkontakte

Kontaktzahlen

No. of contacts

Crimp terminal for screw machined HN.D crimp contacts

(2 x 64/2 x 108) **128/216** +

250 V/10 A

Bezeichnung Description	Bestelltext Designation	Bestell-Nr./Order No.																									
		Stifteinsatz Male insert	Buchseinsatz Female insert																								
<p>Stifteinsatz/Male insert</p> <p>Crimpanschluss/Crimp terminal</p>	2xHN.D.64.Sti.C	2-1103112-3																									
<p>Buchseinsatz/Female insert</p>	2xHN.D.64.BU.C		2-1103113-3																								
<p>Crimpanschluss/Crimp terminal</p>	HN.2D.108.Sti.C.B 1-108 HN.2D.108.Sti.C.B 109-216	2-1103216-3 2-1103217-3																									
<p>HN.D.128</p> <table border="1"> <tr> <td>Maße/Dimensions</td> <td>A</td> <td>B</td> <td>C</td> <td>D</td> <td>E</td> </tr> <tr> <td>mm</td> <td>104</td> <td>110</td> <td>33</td> <td>35</td> <td>35</td> </tr> </table> <p>HN.2D.216</p> <table border="1"> <tr> <td>Maße/Dimensions</td> <td>A</td> <td>B</td> <td>C</td> <td>D</td> <td>E</td> </tr> <tr> <td>mm</td> <td>104</td> <td>110</td> <td>34</td> <td>36,5</td> <td>37</td> </tr> </table>	Maße/Dimensions	A	B	C	D	E	mm	104	110	33	35	35	Maße/Dimensions	A	B	C	D	E	mm	104	110	34	36,5	37	HN.2D.108.Bu.C.B 1-108 HN.2D.108.Bu.C.B 109-216		2-1103220-3 2-1103221-3
Maße/Dimensions	A	B	C	D	E																						
mm	104	110	33	35	35																						
Maße/Dimensions	A	B	C	D	E																						
mm	104	110	34	36,5	37																						

Passende Crimpkontakte siehe Seite 34, Passende Crimpwerkzeuge siehe Seite 34
 Suitable Crimp contacts see page 34, Suitable Crimping tools see page 34

Maßbild mm/Dimensions mm

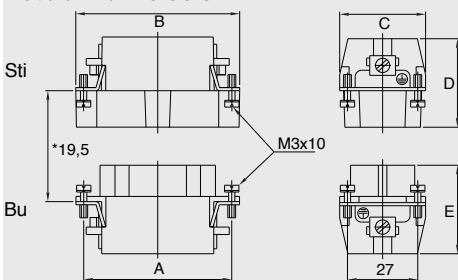

Anschlußseite Stif/Contact arrangement Male insert

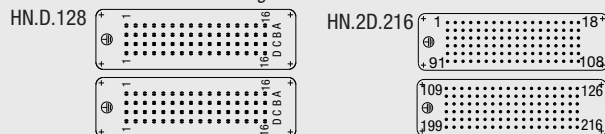

Anschlußseite Buchse/Contact arrangement Female insert

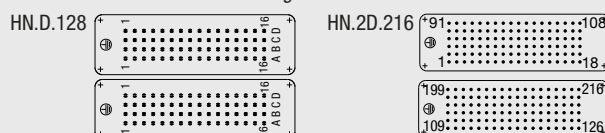

HD.128/HEE 92 Kontakteinsätze/Contact inserts

Baugröße/Size 12

Crimpschluss für gestanzte HD.M Crimpkontakte (HD.128)
 Crimpschluss für gedrehte HVT Crimpkontakte (HEE 92)

Kontaktzahlen
No. of contacts

Crimp terminal for stamped HD.M crimp contacts (HD.128)
Crimp terminal for screw machined HVT crimp contacts (HEE 92)

(2 x 64)/(2 x 46) **128/92 +**

250 V/10 A / 500 V/16 A

Bezeichnung Description	Bestelltext Designation	Bestell-Nr./Order No.	
		Stifteinsatz Male insert	Buchseinsatz Female insert
Stifteinsatz/Male insert Buchseinsatz/Female insert Crimpschluss/Crimp terminal 	2xHD.64.Sti.C 2xHD.64.Bu.C HEE.46.Sti.C HEE.46.Sti.C.B47-92 HEE.46.Bu.C HEE.46.Bu.C.B47-92	2-1103032-3 2-1103033-3 0-1102886-1 0-1102886-2 0-1102887-1 0-1102887-2	

HD.128					
Maße/Dimensions	A	B	C	D	E
mm	104	110	33	35	35

HEE.92					
Maße/Dimensions	A	B	C	D	E
mm	104	110	33	34	37

Passende Crimpkontakte siehe Seite 35/37, Passende Crimpwerkzeuge siehe Seite 35/37
 Suitable Crimp contacts see page 35/37, Suitable Crimping tools see page 35/37

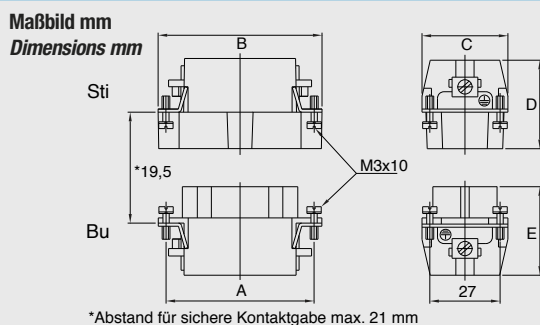

Anschlußseite Stift/
 Contact arrangement
 Male insert

Anschlußseite Buchse/
 Contact arrangement
 Female insert

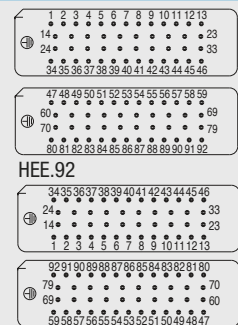
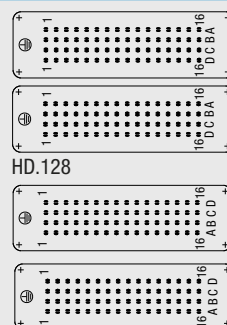

Modul Halterahmen/Module Fixing Frame

Baugröße/Size 12

**Bezeichnung
Description**

**Bestelltext
Designation**

**Bestell-Nr./Order No.
Oberteil
Top part** **Unterteil
Bottom part**

Halterahmen/Fixing frame

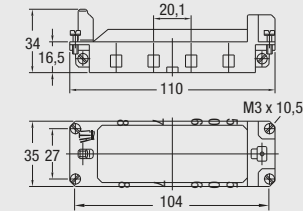
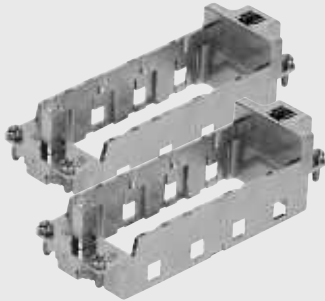

MDL2-GR.0-8/B.1-4
MDL2-GR.0-8/B.5-8

0-1108780-1
0-1108780-6

Für Modul MDL Seite 194–203
For module MDL page 194–203

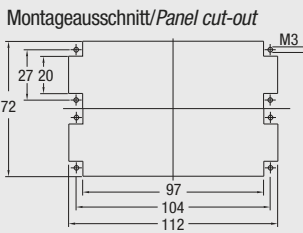

MDL2-GR.U-8/B.1-4
MDL2-GR.U-8/B.5-8

0-1108780-2
0-1108780-7

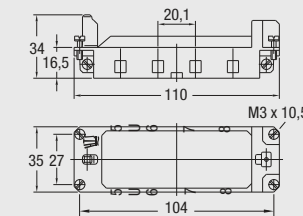
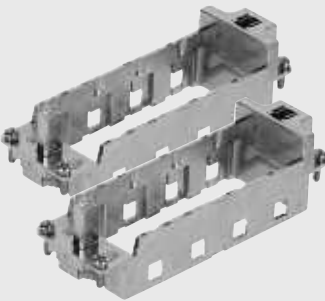

Für Modul MDL Seite 194–203
For module MDL page 194–203

Halterahmen/Fixing frame

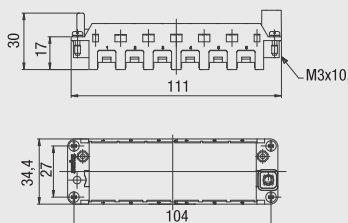

HVS-R.0 1-6
HVS-R.U 1-6

0-1103250-1

0-1103250-2

Für Modul HVS Seite 204–212
For module HVS page 204–212

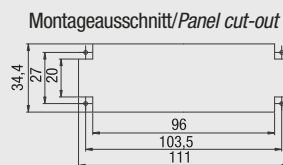

HB.48, HB-K.48 Gehäuse/Housings

Baugröße/Size 12

Pulverbeschichtet, silbergrau
 K = korrosionsgeschützt, schwarz

Powder-coated, silver-grey
K = corrosion-resistant, black

Längsbügel am Unterteil/Side clip at housing bottom

IP 65

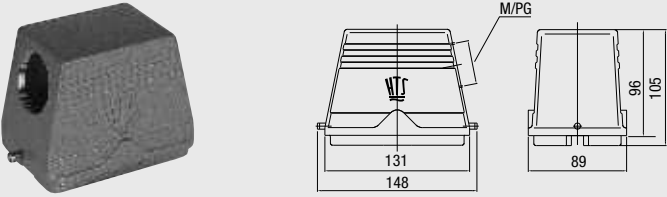
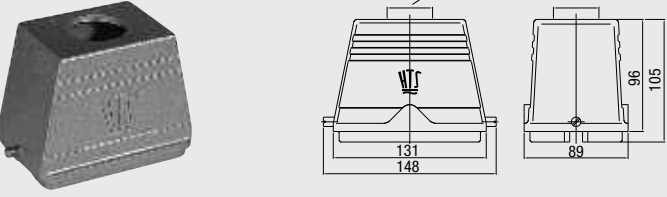
Bezeichnung Description	Metr.	PG	Bestelltext Designation	Bestell-Nr. Order No.	
<p>Steckergehäuse: Kabeleingang seitlich, Standard Bauform <i>Hood: Side entry, Standard construction</i></p> 	M50	29	HB.48.STS-GR.1.29.G	1-1102373-7	
		36	HB.48.STS-GR.1.36.G	1-1102376-7	
		42	HB.48.STS-GR.1.42.G	1-1102379-7	
			HB.48.STS-GR.1.M50.G	0-1106482-2	
			Mit Korrosionsschutz <i>With corrosion protection</i>		
	M50	36	HB-K.48.STS-GR.1.36.G	2-1102376-7	
			HB-K.48.STS-GR.1.M50.G	0-1106482-4	
	<p>Steckergehäuse: Kabeleingang oben, Standard Bauform <i>Hood: Top entry, Standard construction</i></p> 	M50	29	HB.48.STO-GR.1.29.G	1-1102382-7
			36	HB.48.STO-GR.1.36.G	1-1102385-7
			42	HB.48.STO-GR.1.42.G	1-1102388-7
			HB.48.STO-GR.1.M50.G	0-1106482-1	
			Mit Korrosionsschutz <i>With corrosion protection</i>		
M50		36	HB-K.48.STO-GR.1.36.G	2-1102385-7	
			HB-K.48.STO-GR.1.M50.G	0-1106482-6	

Passende Kabelverschraubungen ab Seite 188/Suitable Cable fittings from page 188

HB.48, HB-K.48 Gehäuse/Housings

Baugröße/Size 12

Pulverbeschichtet, silbergrau
 K = korrosionsgeschützt, schwarz

Powder-coated, silver-grey
K = corrosion-resistant, black

Längsbügel am Unterteil/Side clip at housing bottom

IP 65

Bezeichnung Description	Metr.	PG	Bestelltext Designation	Bestell-Nr. Order No.
<p>Anbaugehäuse: Kabeleingang unten, Standard Bauform <i>Surface mounted housing: Bottom entry, Standard construction</i></p>			HB.48.AGD-LB Mit Korrosionsschutz <i>With corrosion protection</i> HB-K.48.AGD-LB	1-1102389-2 2-1102389-2
<p>Sockelgehäuse: Kabeleingang seitlich, Standard Bauform <i>Surface mounted housing: Side entry, Standard construction</i></p>	2xM40	29 2x29 36 2x36	HB.48.SG-LB.1.29.Z HB.48.SG-LB.2.29.Z HB.48.SG-LB.1.36.Z HB.48.SG-LB.2.36.Z HB.48.SG-LB.2.M40.Z Mit Korrosionsschutz <i>With corrosion protection</i> HB-K.48.SG-LB.1.36.Z HB-K.48.SG-LB.2.36.Z	1-1102391-2 1-1102393-2 1-1102395-2 1-1102397-2 0-1106481-2 2-1102395-2 2-1102397-2
<p>Sockelgehäuse: Kabeleingang seitlich, Standard Bauform <i>Surface mounted housing: Side entry, Standard construction</i></p>	2xM40	29 2x29 36 2x36	HB.48.SGD-LB.1.29.Z HB.48.SGD-LB.2.29.Z HB.48.SGD-LB.1.36.Z HB.48.SGD-LB.2.36.Z HB.48.SGD-LB.2.M40.Z Mit Korrosionsschutz <i>With corrosion protection</i> HB-K.48.SGD-LB.1.36.Z HB-K.48.SGD-LB.2.36.Z HB-K.48.SGD-LB.2.M40.Z	1-1107001-2 1-1107003-2 1-1107005-2 1-1107007-2 0-1106481-1 2-1107005-2 2-1107007-2 0-1106481-4

Passende Kabelverschraubungen ab Seite 188/Suitable Cable fittings from page 188

HB/Z.48, HB/Z-K.48 Gehäuse/Housings

Baugröße/Size 12

Pulverbeschichtet, silbergrau
 K = korrosionsgeschützt, schwarz

Powder-coated, silver-grey
K = corrosion-resistant, black

Zentralbügel am Steckergehäuse/Central locking clip on hood

IP 65

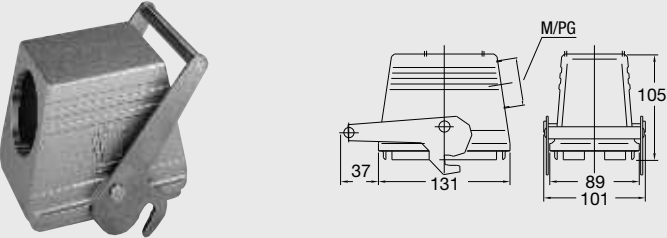
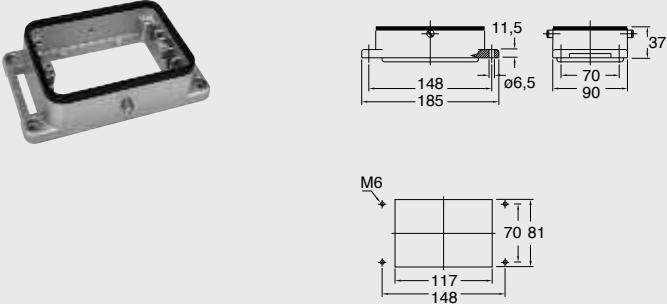
Bezeichnung Description	Metr.	PG	Bestelltext Designation	Bestell-Nr. Order No.
<p>Steckergehäuse: Kabeleingang seitlich, Standard Bauform <i>Hood:</i> Side entry, Standard construction</p> 		<p>42 48</p>	<p>HB/Z.48.Sts-ZB.1.42.G HB/Z.48.Sts-ZB.1.48.G</p> <p>Mit Korrosionsschutz <i>With corrosion protection</i></p> <p>42 48</p> <p>HB-K/Z.48.Sts-ZB.1.42.G HB-K/Z.48.Sts-ZB.1.48.G</p>	<p>1-1102234-3 1-1102236-3</p> <p>2-1102234-3 2-1102236-3</p>
<p>Anbaugeschäuse: Kabeleingang unten, Standard Bauform <i>Surface mounted housing:</i> bottom entry, Standard construction</p> 			<p>HB/Z.48.AG-ZVGR</p> <p>Mit Korrosionsschutz <i>With corrosion protection</i></p> <p>HB-K/Z.48.AG-ZVGR</p>	<p>1-1102237-8</p> <p>2-1102237-8</p>

Passende Kabelverschraubungen ab Seite 188/Suitable Cable fittings from page 188

HF-13 Modul/Module

Baugröße/Size 8/12

**Kontaktzahlen
No. of contacts**



2 + 1; 4 + 1 +

3 kV/350 A

Bezeichnung Description		Bestelltext Designation	Bestell-Nr./Order No. Stifteinsatz Male insert		Buchseinsatz Female insert	
Stifteinsatz/Male insert	Buchseinsatz/Female insert					
		HF.13.Sti.	0-1110950-2			
Powerkontakt Contact for power		HF.13.Bu.			0-1110951-2	
		HF.13.Sti.E	0-1110950-4			
Erdkontakt Contact for grounding		HF.13.Bu.E			0-1110951-4	
<p>3 x Leistung 1 x Erde 1 x BG 2 (HA.10) Montage im HF.12 Gehäuse 3 x for power 1 x for earth 1 x for signal (HA.10) Assembly in HF.12 Housings</p>		HF.12.3+PE+BG2	Oberteil Top 0-1110955-3	Unterteil Bottom 0-1110955-1		
<p>3 x Leistung 1 x Erde 1 x BG 3 (HE.6) Montage im HF.12 Gehäuse 3 x for power 1 x for earth 1 x for signal (HE.6) Assembly in HF.12 Housings</p>		HF.12.3+PE+BG3	0-1110955-4	0-1110955-2		
<p>2 x Leistung 1 x BG61 (HA.3/HE.Q5) Montage im HF.8 Gehäuse 2 x for power 1 x signal Assembly in HF.8 Housings</p>		HF.8.2+BG1 HF.8.2+BG1	0-1110960-2	0-1110960-1* 0-1110960-3**		

* für Gehäuse-Unterteil mit 81 mm Höhe/for Bottomhousing with 81 mm height
** für Gehäuse-Unterteil mit 20 mm Höhe/for Bottomhousing with 20 mm height

Passende Crimpkontakte siehe Seite 42, Passende Crimpwerkzeuge siehe Seite 42
Suitable Crimp contacts see page 42, Suitable Crimping tools see page 42

**Maßbild mm
Dimensions mm**

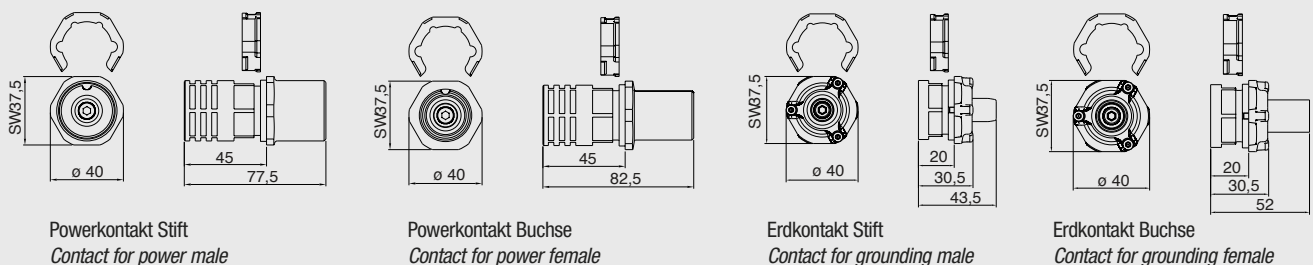







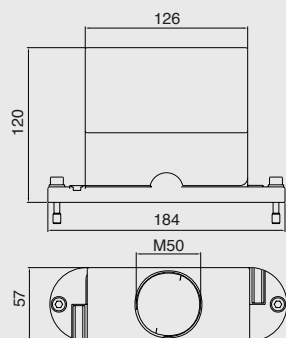

HF-HIP-K 8/HF-EMV-K 8 HF-HIP-K 12/HF-EMV-K 12 Gehäuse/Housings Baugröße/Size 8/12

EMV-K: Schutz gegen elektromagnetische Beeinflussung, druckdicht, korrosionsgeschützt, schwarz
HIP-K: Korrosionsgeschützt, schwarz

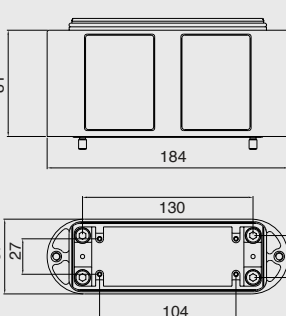
EMV: Protection against electro-magnetic interference, pressure-tight, Housings corrosion-resistant, black
HIP-K: Housings corrosion-resistant, black

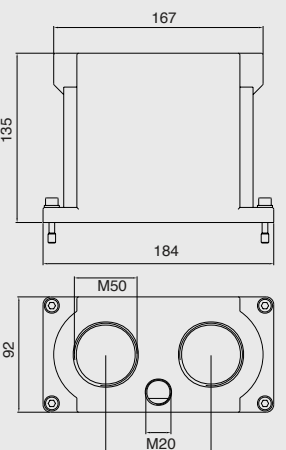
Schraubverriegelung am Oberteil/Screw lock on hood

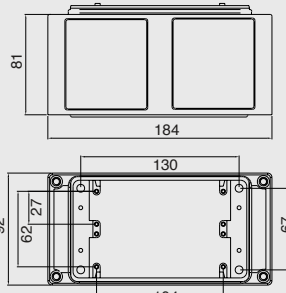
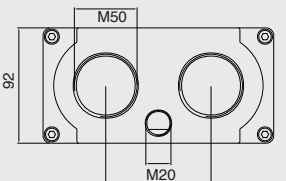
IP 68

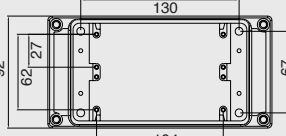
Bezeichnung Description	Metr.	PG	Bestelltext Designation	Bestell-Nr. Order No.
Gehäuseoberteil Hood   	1 x M50		HF-HIP-K.8.Sto.1.M50G	0-1102839-4
	1 x M50		HF.8.EMV-K.8.Sto.1.M50G	0-1102839-3
	2 x M40		HF.HIP-K.8.Sto.2.M40G	0-1102839-2
	2 x M40		HF.EMV-K.8.Sto.2.M40G	0-1102839-1
Gehäuseunterteil Housing bottom   	Höhe/height			
		20 mm	HF-HIP-K.8.AG.N	0-1102837-2
		20 mm	HF-EMV-K.8.AG.N	0-1102837-1
	81 mm		HF-HIP-K.8.AG	0-1102836-2
Gehäuseoberteil Hood   	2 x M40		HF-HIP-K.12.Sto.2.M40G	0-1102840-2
	2 x M40		HF-EMV-K.12.Sto.2.M40G	0-1102840-1
	2 x M50		HF-HIP-K.12.Sto.2.M50G	0-1102840-4
	2 x M50		HF-EMV-K.12.Sto.2.M50G	0-1102840-3
Gehäuseunterteil Housing bottom   	Höhe/height			
		20 mm	HF-HIP-K.12.AG.N	0-1102838-2
		20 mm	HF-EMV-K.12.AG.N	0-1102838-1
	81 mm		HF-HIP-K.12.AG	0-1102192-2
	81 mm		HF-EMVK-K.12.AG	0-1102192-1

Passende Kabelverschraubungen ab Seite 188/Suitable Cable fittings from page 188

Schutzkontakt

Bezeichnung
Description

Bestelltext
Designation

Bestell-Nr.
Order No.

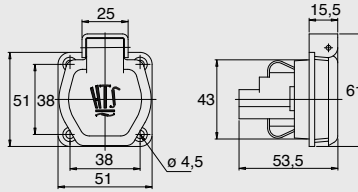

U.P.M

1-1102975-9

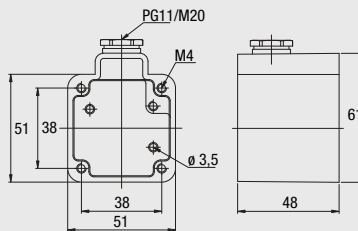

AP.M.11
AP.M.1.M20

1-1102978-9
0-1102978-2

Technische Kennwerte

Kontaktzahlen	2 + PE
el. Bemessungsstrom [A]	10
el. Bemessungsspannung [V]	250
Temperaturbereich	-40°C – +125°C
Schraubanschluss	0,5 – 2,5 mm ²

Technical Specification

<i>No. of Contacts</i>	<i>2 + PE</i>
<i>rated current [A]</i>	<i>10</i>
<i>rated voltage [V]</i>	<i>250</i>
<i>temperature range</i>	<i>-40°C – +125°C</i>
<i>screw terminal</i>	<i>0,5 – 2,5 mm²</i>

Quick-In System/Quick-In System

Bezeichnung
Description

Bestelltext
Designation

Bestell-Nr.
Order No.

Rasterelement zur Verriegelung Stifteinsatz-Buchseinsatz
locking element for fixing ipin insert-socket insert

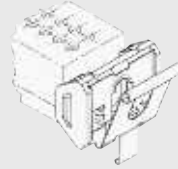

QSB

0-1106515-1

Rasterelement zur Befestigung im Montageausschnitt
locking element for fixing in panel cut-out

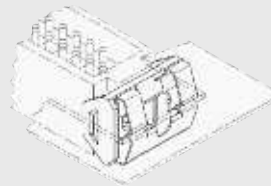

QM

0-1106516-1

Kodierset
Coding set



Cos.Quick-In

0-1110939-3

Zugentlastungsschelle
Cable clamp



ZE-HSB-Quick

0-1108723-1

Blechdicke/Panel strength
min. 1mm – max. 2mm

Blechdicke/Panel strength
2mm – max. 3mm

Baugröße <i>Size</i>	Abmessungen <i>Dimensions</i>	Baugröße <i>Size</i>	Abmessungen <i>Dimensions</i>
	A		A
3	65	3	66
4	78	4	79
6	98,5	6	99,5
8	125	8	126

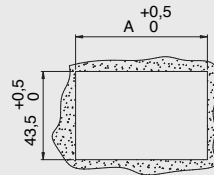

Merkmale

- Befestigung der Rastelemente am Kontakteinsatz ohne Werkzeug
- Funktionalität durch robuste Ausführung
- Bedienerfreundliches Handling
- Höchstmass an Flexibilität
- Kostensenkung durch rationelle Verarbeitung und Entfall der Metallgehäuse
- Platzsparende Montage
- Verwendbar für alle Kontakteinsätze der Baugrößen 3, 4, 6, 8
- Montagekostenreduktion durch Vorassemblage

Characteristics

- *fixing of the locking elements on the contact insert without tools*
- *practicality due to solid execution*
- *user-friendly handling*
- *highest degree of flexibility*
- *cost reduction due to economic finish and omission of metal housings*
- *space-saving assembly*
- *can be used for all contact inserts of the sizes 3, 4, 6, 8*
- *cost reduction due to pre-assembly*

Schraubverbindung für Kontakteinsätze/Screw connection for contact inserts

Schraubverbindung

Rändel- und Buchsenschrauben sichern Kontakteinsätze, die ohne Gehäuse in Schaltschränkausschnitte montiert werden und infolge von Schwingungen eine Trennung der elektrischen Verbindung oder das Herabfallen verhindern. Passende Ausführungen sind für alle rechteckigen Kontakteinsätze der Baugrößen 3, 4, 6, 8, 10, 12 erhältlich.

Screw connection

Thumb and bush screws ensure secure mating of contact inserts which are mounted directly into cut-outs in panels (i. e. without housings). Screw versions are available for all rectangular contact inserts of size 3, 4, 6, 8, 10, 12.

**Rändelschraube
Thumb screw**

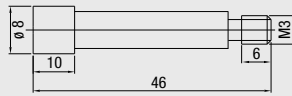

RS-M3

1-1106107-1

Für die Montage der Kontaktträger werden je Steckverbindung 2 Rändel- und 2 Buchsenschrauben eingesetzt.
For the assembly of the contact carriers, you need 2 bush screws and 2 thumb screws for each plug connection.

**Buchsen-schraube
Bush screw**

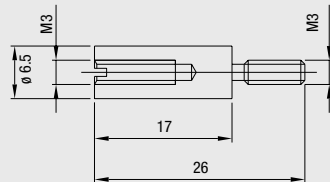

BEBO.M3.KURZ

1-1106109-1





Kodierung/Coding

Kodierungsmöglichkeiten Codings	Bezeichnung Description	Bestelltext Designation	Bestell-Nr. Order No.
<p>Kodierungsmöglichkeiten mit Sperrbolzen Für Gehäuse mit 1 Kontakteinsatz <i>Coding with code pins</i> For housings with 1 contact insert</p> <p>Mit 2 Kontakteinsätzen/<i>with 2 contact inserts</i></p> <p>Kodierungen mit Führungsstiften und -buchsen verhindern weitestgehend ein Schrägstecken und -ziehen des Steckers. Schräglage nach DIN EN 175.301-801 in Längsrichtung $\pm 5^\circ$. <i>Coding with guide pins and bushes prevents angular plugging and unplugging the connector.</i> <i>Max. angle as per DIN EN 175.301-801 (longitudinally) $\pm 5^\circ$.</i></p> <p>Für Gehäuse mit 1 Kontakteinsatz For housings with 1 contact insert</p> <p>Für Gehäuse mit 2 Kontakteinsätzen For housings with 2 contact inserts</p>	<p>Sperrbolzen <i>Code pin</i></p> <p>Pro Steckverbinder werden 4 Sperrbolzen benötigt <i>4 code pins are required per connector</i></p> <p>Sti = Stifteinsatz/<i>Male insert</i> Bu = Buchseneinsatz/<i>Female insert</i> ▲ = Sperrbolzen/<i>Code pin</i> + = Befestigungsschraube/ <i>Fixing screw</i></p> <p>Führungsbuchse <i>Guide bush</i></p> <p>Führungsstift <i>Guide pins</i></p> <p>Sti = Stifteinsatz/<i>Male insert</i> Bu = Buchseneinsatz/<i>Female insert</i> ● = Führungsstift/<i>Guide pin</i> ○ = Führungsbuchse/<i>Guide bush</i> + = Befestigungsschraube/ <i>Fixing screw</i></p>	<p>SPB-M3</p> <p>F-Bu-M3</p> <p>F-Sti-M3</p>	<p>1-1106100-1</p> <p>1-1106101-1</p> <p>1-1106102-1</p>

Schirmkontaktbügel/Screen termination

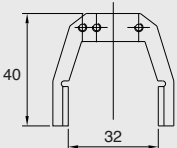
- zur nachträglichen Montage am Kontakteinsatz
- zur Auflage von geschirmten Kabeln

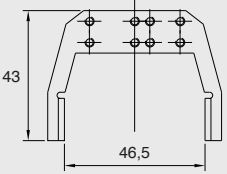

- for post-assembly on contact insert
- for reception of screened cables

Bezeichnung Description	Bestelltext Designation	Bestell-Nr. Order No.
<p>Schirmkontaktbügel Screen termination</p> 	SB.ST.Bgr.3	1-1106305-9
	SB.ST.Bgr.4	1-1106306-9
	SB.ST.Bgr.6	1-1106307-9
	SB.ST.Bgr.8	1-1106308-9
	SB.HSS.Bgr.8	1-1106309-9

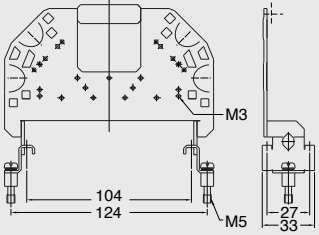
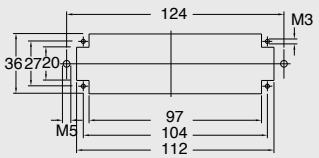
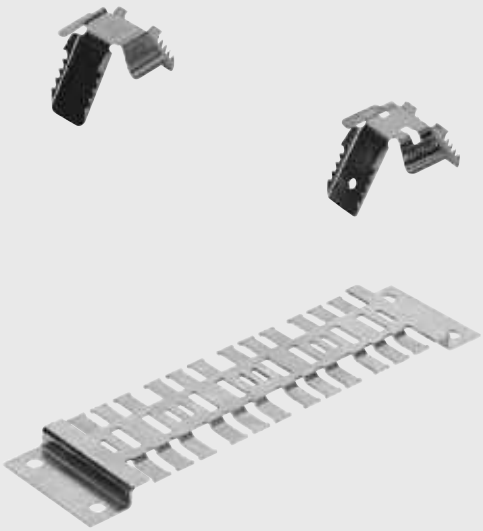

Griffblech/Grip

Griffblech dient als:
Zugentlastung/Schirmauflage/Montage ohne Gehäuse

Grip
Strain relief/Screen bar/Application without housing

Bezeichnung Description	Bestelltext Designation	Bestell-Nr. Order No.
<p>Griffblech Baugröße 8 Grip size 8</p>   <p>Montageausschnitt / Panel cut-out</p> 	<p>GB.1.-BG.8</p>	<p>1-1106301-9</p>
<p>Schirmschiene Braid bar</p>   	<p>S-Schelle gross</p> <p>S-Schelle klein</p> <p>Schirmschiene gerade</p>	<p>0-1102081-1</p> <p>0-1102082-1</p> <p>0-1110505-1</p>

Zubehör für Schirmkontaktbügel/Accessories for screen termination











Bezeichnung Description	Bestelltext Designation	Bestell-Nr. Order No.
<p>Schellenset Cable clamp</p> 	<p>Schellenset/Cable clamp 4,5mm 5mm 6mm 7mm 8mm 9mm 10mm</p>	<p>1-1106302-9 2-1106302-9 3-1106302-9 4-1106302-9 5-1106302-9 6-1106302-9 7-1106302-9</p>
<p>Erdungsband Grounding terminal</p> 	<p>Erdungsband Grounding terminal Set 90mm Set 120mm Set 220mm</p>	<p>1-1106303-9 2-1106303-9 3-1106303-9</p>
<p>Schrauben-Set Screw set</p> 	<p>Schrauben-Set/Screw set</p>	<p>1-1106304-9</p>

Schutzkappe für Gehäuseober- /unterteile/Protective covers for housings

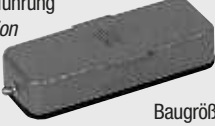
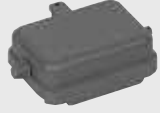
Verstärkte Kunststoffschale (UV-beständig)
Metallausführung

Reinforced plastic shell (UV-resistant)
Metal-Version

Baugröße 1,2,3,4,5,6,8/Size 1,2,3,4,5,6,8

Bezeichnung Description	Bestelltext Designation	Bestell-Nr. Order No.
Schutzkappe für Gehäuseunterteile Protective cover for housings Metall-Ausführung Metal version  Baugröße 1/size 1  Baugröße 1/size 1  Baugröße HG-Q/size HG-Q	HA.3.SKB HG-Q.5.DE HG-Q.5.DE.BL Set-HG-Q.8.SKP	2-1106205-7 0-1103176-1 0-1103176-2 0-1108818-1
Metall-Ausführung Metal version  Baugröße 2/size 2	HB.6.SKB HA.10.SKB	1-1106207-7 2-1106206-7
Metall-Ausführung Metal version  Baugröße 5/size 5	HA.16.SKB	2-1106208-7
 Baugröße 3/size 3	mit Fangsnur with attachment string HB.6.SKP	5-1106207-7
 Baugröße 4/size 4	mit Fangsnur with attachment string HB.10.SKP	5-1106213-6
 Baugröße 6/size 6	mit Fangsnur with attachment string HB.16.SKP-VS HB.16.SKP-LB	2-1106214-0 3-1106214-0
 Baugröße 8/size 8	mit Fangsnur with attachment string HB.24.SKP-VS HB.24.SKP-LB	2-1106216-0 3-1106216-0
Schutzkappe für Gehäuseoberteile Kunststoffschale/Protective cover for housings Plastic shell  Baugröße 6/size 6	HB.16.SKP-VS+D	2-1106214-1
 Baugröße 8/size 8	HB.24.SKP-VS+D	2-1106216-1

Schutzdeckel für Gehäuseober- /unterteile/Protective covers for hoods and housings

Verstärkte Kunststoffschale (UV-beständig), Ausführung mit und ohne Fangschnur
Metallausführung

Reinforced plastic shell (UV-resistant), Versions with/without attachment string
Metal-Version

Baugröße 3, 4, 6 + 8/Size 3, 4, 6 + 8

Bezeichnung
 Description

Bestell-Nr.
 Order No.

Schutzdeckel für Gehäuseober- und Gehäuseunterteile mit Bolzen
Protective cover for hoods and housings with bolts



Baugröße 6/8/size 6/8

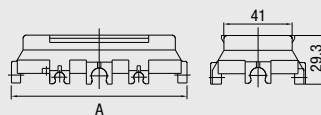

Baugröße/Size	A = mm
6	105
8	132

SKP.6
 SKP.8

0-1110684-3
 0-1110661-3

mit Fangschnur
with attachment string

SKP.6.F
 SKP.8.F

0-1106258-3
 0-1106258-4

Schutzdeckel für Gehäuseoberteile mit Zentralbügel
Protective cover for hoods with central locking clip



Baugröße 6/8/size 6/8

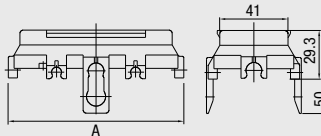

Baugröße/Size	A = mm
6	105
8	132

SKP.6/R
 SKP.8/R

0-1110684-4
 0-1110661-4

mit Fangschnur
with attachment string

SKP.6/R.F
 SKP.8/R.F

0-1106259-3
 0-1106259-4

Schutzkappen für Gehäuse-Unterteile Serien HIP, EMV, EMV-K
Protective covers for housings series HIP, EMV, EMV-K

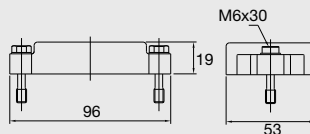

HIP
 HIP/EMV.6/16.SKB

3-1106201-5

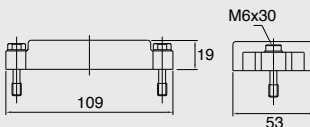

HIP
 HIP/EMV.10/24.SKB

3-1106202-5

HIP-K/EMV-K
 HIP-K/EMV-K.10/24.SKB

4-1106202-5

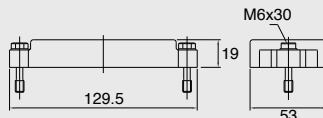

HIP
 HIP/EMV.16/40.SKB

3-1106203-5

HIP-K
 HIP-K.16/40.SKB

4-1106203-5

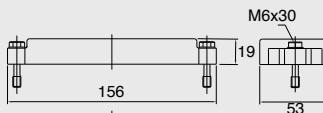

HIP
 HIP/EMV.24/64.SKB

3-1106204-5

HIP-K/EMV-K
 HIP-K/EMV-K.24/64.SKB



4-1106204-5

Adapterbleche für SUB-D Einsätze/Adapter plates for SUB-D inserts

Zur Montage von SUB-D Einsätzen

For assembly of SUB-D inserts

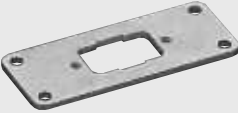
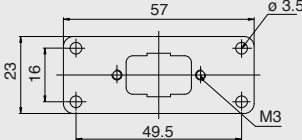
Adapterplatten für Serie HA/Adapterplates for Series HA

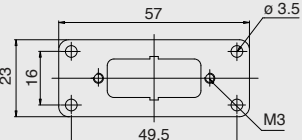
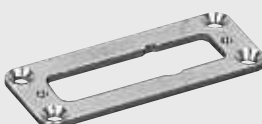
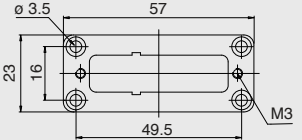
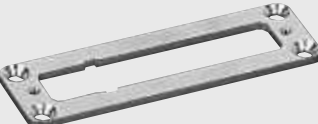
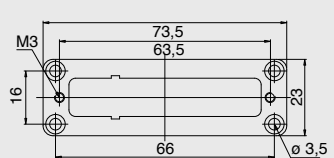
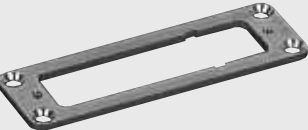
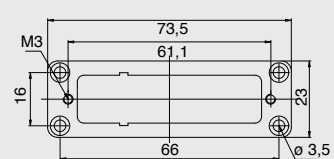
Bezeichnung Description	Bestelltext Designation	Bestell-Nr./ Order No. Oberteile for hood Unterteile for bottom		
Für Gehäuse HA.10 For housings HA.10				
		1 x 9	0-1107197-1	0-1107196-1
		1 x 15	0-1107197-2	0-1107196-2
		1 x 25	0-1107197-3	0-1107196-3
Für Gehäuse HA.16 For housings HA.16				
		1 x 37	0-1107203-1	0-1107202-1
		1 x 50	0-1107203-2	0-1107202-2

Adapterbleche für SUB-D Einsätze/Adapter plates for SUB-D inserts

Zur Montage von SUB-D Einsätzen

For assembly of SUB-D inserts

Adapterplatten für Serie HB/Adapterplates for Series HB

Bezeichnung Description	Bestelltext Designation	Bestell-Nr./ Order No. Oberteile for hood	Unterteile for bottom
Für Gehäuse HB.6 For housings HB.6	2 x 9	0-1107199-1	0-1107198-1
	2 x 15	0-1107199-2	0-1107198-2
Für Gehäuse HB.10 For housings HB.10	1 x 15 + 25	0-1107201-2	0-1107200-2
	2 x 25	0-1107201-1	0-1107200-1
Für Gehäuse HB.16 For housings HB.16	1 x 25 + 37	0-1107205-2	0-1107204-2
	2 x 37	0-1107205-3	0-1107204-3
	2 x 50		0-1107204-4
Für Gehäuse HB.16 For housings HB.16	1 x 9 + 15 + 25	0-1107205-1	0-1107204-1

Kabelverschraubungen und Zubehör/Cable fittings and accessories

EMV-Kabelverschraubung
Schutz gegen elektromagnetische Beeinflussung

EMV-cable-fitting
Protect against electro-magnetic influence

IP 68

Bezeichnung
Description

Metr.
 PG

Bestelltext
Designation

Bestell-Nr.
Order No.

EMV-Kabelverschraubung
EMV-cable fitting

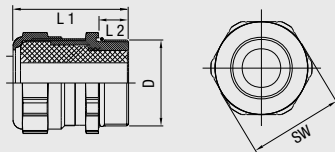

D	~L1	L2	SW	Kabel ø	
				min	max
M16	27	5	17	5	9
M20	30	6	22	8	13
M25	35	7	27	11	16
M32	40	8	34	15	21
M40	45	8	43	19	27
M50	50	9	55	26	35

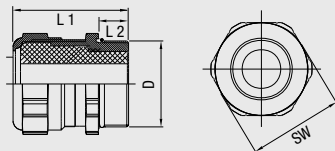

D	~L1	L2	SW	Kabel ø	
				min	max
PG 16	27	5	17	5	9
PG 21	30	6	22	8	13
PG 29	35	7	27	11	16



M16
M20
M25
M32
M40
M50

EMV.M16.MS
EMV.M20.MS
EMV.M25.MS
EMV.M32.MS
EMV.M40.MS
EMV.M50.MS

1-1102772-6
2-1102772-0
2-1102772-5
3-1102772-2
4-1102772-0
5-1102772-0

16
21
29





EMV.PG16
EMV.PG21
EMV.PG29

1-1106007-4
1-1106007-9
2-1106007-3

Kabelverschraubungen und Zubehör/Cable fittings and accessories

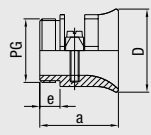
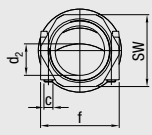
TDS-Kabelverschraubung AL-Druckguss
DS-Kabelverschraubung Metall

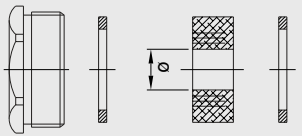
TDS cable fitting diecast aluminium alloy
DS cable fitting metal

Bezeichnung Description	Metr.	PG	Bestelltext Designation	Bestell-Nr. Order No.																																																																								
<p>TDS-Kabelverschraubung: AL-Druckguss mit Biegeschutz-Trompete und Zugentlastung TDS cable fitting: Diecast aluminum alloy with bell mouth for cable bending protection and strain relief</p>    <table border="1"> <thead> <tr> <th>PG</th> <th>a</th> <th>c</th> <th>D</th> <th>d 2</th> <th>e</th> <th>SW</th> <th>f</th> </tr> <tr> <td></td> <td></td> <td></td> <td></td> <td>min max</td> <td></td> <td></td> <td></td> </tr> </thead> <tbody> <tr> <td>11</td> <td>30</td> <td>M 3</td> <td>27</td> <td>8,5 12</td> <td>8</td> <td>22</td> <td>25</td> </tr> <tr> <td>13,5</td> <td>32</td> <td>M 3</td> <td>30</td> <td>8,5 15</td> <td>8,5</td> <td>24</td> <td>28</td> </tr> <tr> <td>16</td> <td>32</td> <td>M 4</td> <td>32</td> <td>10 17</td> <td>9</td> <td>27</td> <td>30</td> </tr> <tr> <td>21</td> <td>35</td> <td>M 4</td> <td>37</td> <td>13,5 21,5</td> <td>9</td> <td>32</td> <td>35</td> </tr> <tr> <td>29</td> <td>40</td> <td>M 5</td> <td>52</td> <td>19 29,5</td> <td>9</td> <td>46</td> <td>50</td> </tr> <tr> <td>36</td> <td>50</td> <td>M 6</td> <td>62</td> <td>25 38</td> <td>13</td> <td>50</td> <td>61,5</td> </tr> <tr> <td>42</td> <td>55,5</td> <td>M 6</td> <td>65</td> <td>30 43</td> <td>16</td> <td>55</td> <td>64</td> </tr> </tbody> </table>	PG	a	c	D	d 2	e	SW	f					min max				11	30	M 3	27	8,5 12	8	22	25	13,5	32	M 3	30	8,5 15	8,5	24	28	16	32	M 4	32	10 17	9	27	30	21	35	M 4	37	13,5 21,5	9	32	35	29	40	M 5	52	19 29,5	9	46	50	36	50	M 6	62	25 38	13	50	61,5	42	55,5	M 6	65	30 43	16	55	64		11 13,5 16 21 29 36 42	TDS.11.M TDS.13.M TDS.16.M TDS.21.M TDS.29.M TDS.36.M TDS.42.M	1-1106001-9 2-1106001-9 3-1106001-9 4-1106001-9 5-1106001-9 6-1106001-9 7-1106001-9
PG	a	c	D	d 2	e	SW	f																																																																					
				min max																																																																								
11	30	M 3	27	8,5 12	8	22	25																																																																					
13,5	32	M 3	30	8,5 15	8,5	24	28																																																																					
16	32	M 4	32	10 17	9	27	30																																																																					
21	35	M 4	37	13,5 21,5	9	32	35																																																																					
29	40	M 5	52	19 29,5	9	46	50																																																																					
36	50	M 6	62	25 38	13	50	61,5																																																																					
42	55,5	M 6	65	30 43	16	55	64																																																																					
<p>DS-Kabelverschraubung aus Metall, mit 2 Druckringen und ausschneidbaren Dichtring DS cable fitting metal, with 2 pressure rings and cut-out sealing ring</p>   <table border="1"> <thead> <tr> <th>PG</th> <th>ø min</th> <th>ø max</th> <th>SW</th> </tr> </thead> <tbody> <tr> <td>11</td> <td>7,5</td> <td>12,5</td> <td>18</td> </tr> <tr> <td>13,5</td> <td>7,5</td> <td>12,5</td> <td>20</td> </tr> <tr> <td>16</td> <td>7,5</td> <td>15</td> <td>22</td> </tr> <tr> <td>21</td> <td>10</td> <td>19</td> <td>28</td> </tr> <tr> <td>29</td> <td>18</td> <td>27</td> <td>37</td> </tr> <tr> <td>36</td> <td>24</td> <td>33</td> <td>47</td> </tr> <tr> <td>42</td> <td>30</td> <td>39</td> <td>54</td> </tr> </tbody> </table>	PG	ø min	ø max	SW	11	7,5	12,5	18	13,5	7,5	12,5	20	16	7,5	15	22	21	10	19	28	29	18	27	37	36	24	33	47	42	30	39	54		11 13,5 16 21 29 36 42	DS.11.DI DS.13.DI DS.16.DI DS.21.DI DS.29.DI DS.36.DI DS.42.DI	1-1106004-9 2-1106004-9 3-1106004-9 4-1106004-9 5-1106004-9 6-1106004-9 7-1106004-9																																								
PG	ø min	ø max	SW																																																																									
11	7,5	12,5	18																																																																									
13,5	7,5	12,5	20																																																																									
16	7,5	15	22																																																																									
21	10	19	28																																																																									
29	18	27	37																																																																									
36	24	33	47																																																																									
42	30	39	54																																																																									
<p>Dichtungsset für Gehäuseserie HA.3 für IP 65 Dichtring Gastset for series HA.3 hoods; IP 65</p>  <p>für HA.3 Stecker/for series HA.3 hood</p>  <p>für HA.3 Anbau-/Sockel- oder Kupplungsgehäuse/for series HA.3 housings</p>			SetM3x8Dicht2 SetM3x8Dicht1	0-1103028-2 0-1103028-1																																																																								

Kabelverschraubungen und Zubehör/Cable fittings and accessories

HUT-Verschraubung Kunststoff
HUT-Verschraubung Messing, vernickelt

Gland fitting plastic
Gland fitting brass, nickel plated

IP 68

Bezeichnung
Description

Metr.
 PG

Bestelltext
Designation

Bestell-Nr.
Order No.

Hut-Verschraubung PG, IP 68 aus Kunststoff
Gland fitting IP 68 plastic

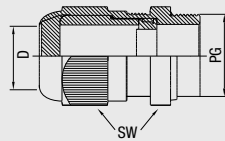

PG	D min	D max	SW
11	5	10	22
13,5	6	12	24
16	10	14	27
21	13	18	33
29	18	25	42
36	22	32	53
42	32	38	60

Hut-Verschraubung M, IP 68 aus Kunststoff
Gland fitting IP 68 plastic

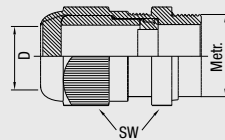

Metr.	D min	D max	SW
M16	4	8	20
M20	6	12	24
M25	10	14	29
M32	13	18	36
M40	18	25	46
M50	22	32	55

Hut-Verschraubung IP 68 Messing, vernickelt
 Neoprene-Dichteinsatz und O-Dichtring am Anschlussgewinde
Gland fitting IP 68 brass, nickel-plated neoprene sealing insert and O ring at connection thread

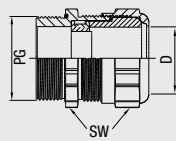

PG	D min	D max	SW
11	5	10	20
13,5	6	12	22
16	10	14	24
21	13	18	30
29	18	25	40
36	22	32	50
42	32	38	57

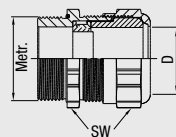

Metr.	D min	D max	SW
M16	5	10	17
M20	6	12	22
M25	13	18	27
M32	18	25	34
M40	22	32	43
M50	32	38	55

M16
M20
M25
M32
M40
M50

HUT.M16.P
HUT.M20.P
HUT.M25.P
HUT.M32.P
HUT.M40.P
HUT.M50.P

1-1102771-6
2-1102771-0
2-1102771-5
3-1102771-2
4-1102771-0
5-1102771-0

11
13,5
16
21
29
36
42

HUT.11.MS
HUT.13.MS
HUT.16.MS
HUT.21.MS
HUT.29.MS
HUT.36.MS
HUT.42.MS

1-1106006-9
2-1106006-9
3-1106006-9
4-1106006-9
5-1106006-9
6-1106006-9
7-1106006-9

M16
M20
M25
M32
M40
M50





HUT.M16.MS
HUT.M20.MS
HUT.M25.MS
HUT.M32.MS
HUT.M40.MS
HUT.M50.MS

1-1102770-6
2-1102770-0
2-1102770-5
3-1102770-2
4-1102770-0
5-1102770-0

Kabelverschraubungen und Zubehör/Cable fittings and accessories

GM-Gegenmuttern, BS-Blindstopfen, Zwischenstutzen 6kt
Messing, vernickelt

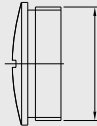
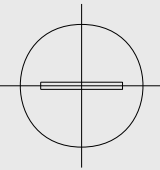

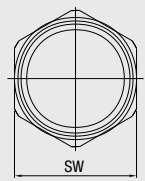
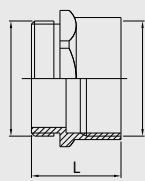
GM lock nut, BS blanking piece, hexagonal adaptor
Brass, nickel plated

Bezeichnung Description	Metr.	PG	Bestelltext Designation	Bestell-Nr. Order No.																										
<p>GM-Gegenmuttern Messing vernickelt, bei dünnwandiger Gehäusewand Verschraubung kontern GM lock nut brass nickel-plated, used to lock screwed fittings (housings with thin walls)</p>  <table border="1" data-bbox="667 672 826 936"> <thead> <tr> <th>SW</th> <th>Stärke Thickness</th> </tr> </thead> <tbody> <tr><td>21</td><td>3</td></tr> <tr><td>23</td><td>3</td></tr> <tr><td>26</td><td>3</td></tr> <tr><td>32</td><td>3,5</td></tr> <tr><td>41</td><td>4</td></tr> <tr><td>51</td><td>5</td></tr> <tr><td>60</td><td>5</td></tr> </tbody> </table>	SW	Stärke Thickness	21	3	23	3	26	3	32	3,5	41	4	51	5	60	5		11 13,5 16 21 29 36 42	GM.11.SKT-MS GM.13.SKT-MS GM.16.SKT-MS GM.21.SKT-MS GM.29.SKT-MS GM.36.SKT-MS GM.42.SKT-MS	1-1106055-2 2-1106055-2 3-1106055-2 4-1106055-2 5-1106055-2 6-1106055-2 7-1106055-2										
	SW	Stärke Thickness																												
	21	3																												
	23	3																												
	26	3																												
	32	3,5																												
	41	4																												
	51	5																												
	60	5																												
	<p>BS-Blindstopfen Messing vernickelt (O-Dichtring bitte separat bestellen) BS blanking piece brass nickel-plated (please order O ring separately)</p>   	M16 M20 M25 M32 M40 M50	11 13,5 16 21 29 36 42	BS.11.MS BS.13.MS BS.16.MS BS.21.MS BS.29.MS BS.36.MS BS.42.MS BS.M16.MS BS.M20.MS BS.M25.MS BS.M32.MS BS.M40.MS BS.M50.MS	1-1106056-3 2-1106056-3 3-1106056-3 4-1106056-3 5-1106056-3 6-1106056-3 7-1106056-3 1-1102773-6 2-1102773-0 2-1102773-5 3-1102773-2 4-1102773-0 5-1102773-0																									
		<p>Zwischenstutzen-6kt. Messing vernickelt (O-Dichtring bitte separat bestellen) Hexagonal adaptor brass, nickel-plated (please order O ring separately)</p>    <table border="1" data-bbox="603 1792 766 2033"> <thead> <tr> <th>PG</th> <th>L</th> <th>SW</th> </tr> </thead> <tbody> <tr><td>11</td><td>17</td><td>20</td></tr> <tr><td>13,5</td><td>19</td><td>22</td></tr> <tr><td>16</td><td>20</td><td>24</td></tr> <tr><td>21</td><td>22</td><td>30</td></tr> <tr><td>29</td><td>24,5</td><td>40</td></tr> <tr><td>36</td><td>28,5</td><td>50</td></tr> <tr><td>42</td><td>32</td><td>57</td></tr> </tbody> </table>	PG	L	SW	11	17	20	13,5	19	22	16	20	24	21	22	30	29	24,5	40	36	28,5	50	42	32	57		11 13,5 16 21 29 36 42	ZW.ST.11.SKT-MS ZW.ST.13.SKT-MS ZW.ST.16.SKT-MS ZW.ST.21.SKT-MS ZW.ST.29.SKT-MS ZW.ST.36.SKT-MS ZW.ST.42.SKT-MS	1-1106057-4 2-1106057-4 3-1106057-4 4-1106057-4 5-1106057-4 6-1106057-4 7-1106057-4
			PG	L	SW																									
11			17	20																										
13,5			19	22																										
16			20	24																										
21			22	30																										
29			24,5	40																										
36			28,5	50																										
42			32	57																										

Kabelverschraubungen und Zubehör/Cable fittings and accessories

**ERW-Erweiterung, REDU 6kt, Messing, vernickelt
Adapter NPT-PG**

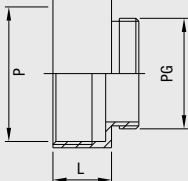
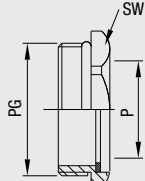
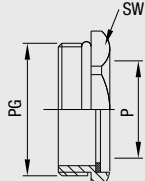

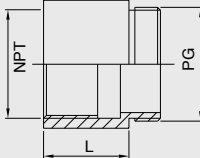
**ERW increasing piece, REDU hexagonal reducing piece, Brass, nickel plated
Adaptor NPT-PG**

Bezeichnung Description	Metr.	PG	Bestelltext Designation	Bestell-Nr. Order No.																																							
<p>ERW-Erweiterung Messing vernickelt <i>ERW increasing piece</i> brass, nickel-plated</p>   <table border="1"> <thead> <tr> <th>PG</th> <th>P</th> <th>L</th> </tr> </thead> <tbody> <tr><td>11</td><td>13,5</td><td>11,5</td></tr> <tr><td>11</td><td>16</td><td>11,5</td></tr> <tr><td>13,5</td><td>16</td><td>12,5</td></tr> <tr><td>13,5</td><td>21</td><td>12,5</td></tr> <tr><td>16</td><td>21</td><td>14,5</td></tr> <tr><td>21</td><td>29</td><td>16</td></tr> <tr><td>29</td><td>36</td><td>19,5</td></tr> <tr><td>36</td><td>42</td><td>22</td></tr> </tbody> </table>	PG	P	L	11	13,5	11,5	11	16	11,5	13,5	16	12,5	13,5	21	12,5	16	21	14,5	21	29	16	29	36	19,5	36	42	22			11\13,5 11\16 13,5\16 13,5\21 16\21 21\29 29\36 ERW.11/13.MS ERW.11/16.MS ERW.13/16.MS ERW.13/21.MS ERW.16/21.MS ERW.21/29.MS ERW.29/36.MS	1-1106058-5 7-1106058-5 2-1106058-5 8-1106058-5 3-1106058-5 4-1106058-5 5-1106058-5												
PG	P	L																																									
11	13,5	11,5																																									
11	16	11,5																																									
13,5	16	12,5																																									
13,5	21	12,5																																									
16	21	14,5																																									
21	29	16																																									
29	36	19,5																																									
36	42	22																																									
<p>REDU-6kt. Reduzierung Messing vernickelt <i>REDU hexagonal reducing piece</i> brass, nickel-plated</p>   <table border="1"> <thead> <tr> <th>PG</th> <th>P</th> <th>SW</th> </tr> </thead> <tbody> <tr><td>11</td><td>9</td><td>20</td></tr> <tr><td>13,5</td><td>9</td><td>24</td></tr> <tr><td>13,5</td><td>11</td><td>24</td></tr> <tr><td>16</td><td>11</td><td>24</td></tr> <tr><td>16</td><td>13,5</td><td>24</td></tr> <tr><td>21</td><td>13,5</td><td>32</td></tr> <tr><td>21</td><td>16</td><td>41</td></tr> <tr><td>29</td><td>16</td><td>41</td></tr> <tr><td>29</td><td>21</td><td>41</td></tr> <tr><td>36</td><td>21</td><td>50</td></tr> <tr><td>36</td><td>29</td><td>50</td></tr> <tr><td>42</td><td>29</td><td>60</td></tr> </tbody> </table>	PG	P	SW	11	9	20	13,5	9	24	13,5	11	24	16	11	24	16	13,5	24	21	13,5	32	21	16	41	29	16	41	29	21	41	36	21	50	36	29	50	42	29	60			13,5\9 13,5\11 16\11 16\13 21\13 21\16 29\16 29\21 36\21 36\29 REDU.13/09.MS.8 REDU.13/11.MS.8 REDU.16/11.MS.8 REDU.16/13.MS.8 REDU.21/13.MS.8 REDU.21/16.MS.8 REDU.29/16.MS.8 REDU.29/21.MS.8 REDU.36/21.MS.8 REDU.36/29.MS.8	8-1106062-6 2-1106062-6 9-1106062-6 3-1106062-6 0-1106062-6 4-1106062-6 0-1106062-7 5-1106062-6 1-1106062-7 6-1106062-6
PG	P	SW																																									
11	9	20																																									
13,5	9	24																																									
13,5	11	24																																									
16	11	24																																									
16	13,5	24																																									
21	13,5	32																																									
21	16	41																																									
29	16	41																																									
29	21	41																																									
36	21	50																																									
36	29	50																																									
42	29	60																																									
<p>Adapter NPT-PG <i>Adapter NPT-PG</i></p>   <table border="1"> <thead> <tr> <th>PG</th> <th>NPT</th> <th>L</th> </tr> </thead> <tbody> <tr><td>11</td><td>3/8"</td><td>14</td></tr> <tr><td>13,5</td><td>1/2"</td><td>18</td></tr> <tr><td>16</td><td>1/2"</td><td>18</td></tr> <tr><td>21</td><td>3/4"</td><td>18</td></tr> <tr><td>36</td><td>1 1/4"</td><td>20</td></tr> <tr><td>42</td><td>1 1/4"</td><td>18</td></tr> </tbody> </table>	PG	NPT	L	11	3/8"	14	13,5	1/2"	18	16	1/2"	18	21	3/4"	18	36	1 1/4"	20	42	1 1/4"	18			11/3/8" 13,5/1/2" 16/1/2" 21/3/4" 36/1 1/4" Ü-PG.11-NPT.3/8 Ü-PG.13-NPT.1/2 Ü-PG.16-NPT.1/2 Ü-PG.21-NPT.3/4 Ü-PG.36-NPT.1 1/4	1-1106066-8 2-1106066-8 3-1106066-8 4-1106066-8 6-1106066-8																		
PG	NPT	L																																									
11	3/8"	14																																									
13,5	1/2"	18																																									
16	1/2"	18																																									
21	3/4"	18																																									
36	1 1/4"	20																																									
42	1 1/4"	18																																									

Kabelverschraubungen und Zubehör/Cable fittings and accessories

**ERW-Erweiterung, REDU 6kt, Messing, vernickelt
Adapter NPT-PG**

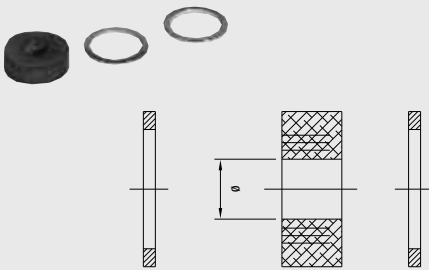
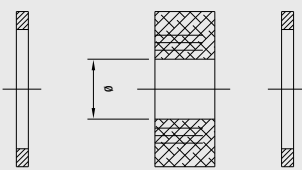
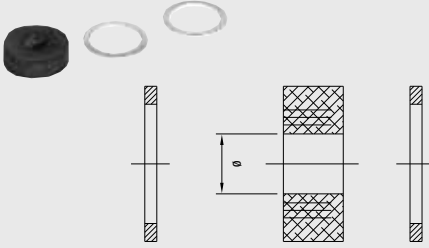
**ERW increasing piece, REDU hexagonal reducing piece, Brass, nickel plated
Adaptor NPT-PG**

Bezeichnung Description	Metr.	PG	Bestelltext Designation	Bestell-Nr. Order No.
Ausschneidbarer Dichtring Neoprene schwarz, mit 2 Metall-Druckscheiben <i>Cut-out sealing ring</i> Neoprene black 2 metal pressure rings 		11	ASD.11.N	1-1106050-1
		13,5	ASD.13.N	2-1106050-1
		16	ASD.16.N	3-1106050-1
		21	ASD.21.N	4-1106050-1
		29	ASD.29.N	5-1106050-1
		36	ASD.36.N	6-1106050-1
		42	ASD.42.N	7-1106050-1
Ausschneidbarer Dichtring für K-Serie <i>Cut-out sealing ring</i> for K-series 		16	ASD-K.16.N	3-1106051-1
		21	ASD-K.21.N	4-1106051-1
		29	ASD-K.29.N	5-1106051-1
Viton , mit 2 Kunststoff-Druckscheiben, für hohe Temperaturen <i>Viton</i> , 2 plastic pressure rings for high temperatures 		11	ASD-K.11.V	1-1106052-1
		21	ASD-K.21.V	4-1106052-1
		36	ASD-K.36.V	6-1106052-1
		42	ASD-K.42.V	7-1106052-1
O-Dichtringe Standard schwarz <i>O rings</i> standard black 	M20	11	O-RING.11.SCHW	1-1106053-1
		13,5	O-RING.13.SCHW	2-1106053-1
	M25	16	O-RING.16.SCHW	3-1106053-1
	M32	21	O-RING.21.SCHW	4-1106053-1
	M40	29	O-RING.29.SCHW	5-1106053-1
	M50	36	O-RING.36.SCHW	6-1106053-1
O-Dichtringe Viton, für hohe Temperaturen bis 200° C Dauertemperatur <i>O rings</i> Viton, for high temperatures (up to 200° C permanent temperature) 		11	O-RING.11.VITON	1-1106053-2
	M20	13,5	O-RING.13.VITON	2-1106053-2
	M40	29	O-RING.29.VITON	5-1106053-2
		42	O-RING.42.VITON	7-1106053-2

PG	D min	D max
11	7,5	12,5
13,5	7,5	12,5
16	7,5	15
21	10	19
29	18	27
36	24	33
42	30	39

PG	D min	D max
11	7,5	12,5
13,5	7,5	12,5
16	7,5	15
21	10	19
29	18	27
36	24	33
42	30	39

Innen-Durchmesser x Schnurstärke Inner diameter x ring diameter
16x1,5
18x1,5
20x1,5
26x2
34x2
44x2
50x2

HF-Modul/HF-Module

150 A HF 06-Kontakt

Kontaktzahlen
No. of contacts

150 A HF 06-contact

1 + 2

1000V/150A, 250V/10A

Bezeichnung Description	Bestelltext Designation	Bestell-Nr./Order No.	
		Stifteinsatz Male insert	Buchseinsatz Female insert
Oberteil für Stiftkontakte Top part for male contacts	MDL2.1+2.Sti.C	0-1103024-1	
Unterteil für Buchsenkontakte Bottom part for female contacts	MDL2.1+2.Bu.C		0-1103024-2

Passende Crimpkontakte siehe Seite 34 + 41, Passende Crimpwerkzeuge siehe Seite 34 + 42
Suitable Crimp contacts see page 34 + 41, Suitable Crimping tools see page 34 + 42

Maßbild mm Dimensions mm	Kontaktanordnung Anschlußseite: Oberteil Contact arrangement termination side: top part	Kontaktanordnung Anschlußseite: Unterteil Contact arrangement termination side: bottom part

HSS Modul/HSS Module

für HSS Crimp Kontakte

Kontaktzahlen
No. of contacts

for HSS crimp contacts

2 + 2

1000V/63A, 250V/10A

Bezeichnung Description	Bestelltext Designation	Bestell-Nr./Order No.	
		Stifteinsatz Male insert	Buchseinsatz Female insert
Oberteil für Stiftkontakte Top part for male contacts	MDL2.2+2.Sti.C	0-1103019-1	
Unterteil für Buchsenkontakte Bottom part for female contacts	MDL2.2+2.Bu.C		0-1103019-2

Passende Crimpkontakte siehe Seite 34 + 41, Passende Crimpwerkzeuge siehe Seite 34 + 41
Suitable Crimp contacts see page 34 + 41, Suitable Crimping tools see page 34 + 41

Maßbild mm Dimensions mm	Kontaktanordnung Anschlußseite: Oberteil Contact arrangement termination side: top part	Kontaktanordnung Anschlußseite: Unterteil Contact arrangement termination side: bottom part

HSM Modul/HSM Module

für HSM Crimp Kontakte

for HSM crimp contacts

Kontaktzahlen
No. of contacts

3 + 4

1000V/40A, 250V/10A

Bezeichnung Description	Bestelltext Designation	Bestell-Nr./Order No.	
		Stifteinsatz Male insert	Buchseinsatz Female insert
Oberteil für Stiftkontakte Top part for male contacts 	MDL2.3+4.Sti.C	0-1103018-1	
Unterteil für Buchsenkontakte Bottom part for female contacts 	MDL2.3+4.Bu.C		0-1103018-2

Passende Crimpkontakte siehe Seite 34 + 40, Passende Crimpwerkzeuge siehe Seite 34 + 40
Suitable Crimp contacts see page 34 + 40, Suitable Crimping tools see page 34 + 40

Maßbild mm
Dimensions mm

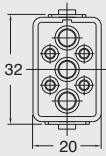

Kontaktanordnung Anschlußseite: Oberteil
Contact arrangement termination side: top part



Kontaktanordnung Anschlußseite: Unterteil
Contact arrangement termination side: bottom part



HVT-Modul/HVT-Module

für HVT Crimp Kontakte

for HVT crimp contacts

Kontaktzahlen
No. of contacts

8

400V/16A

Bezeichnung Description	Bestelltext Designation	Bestell-Nr./Order No.	
		Stifteinsatz Male insert	Buchseinsatz Female insert
Oberteil für Stiftkontakte Top part for male contacts 	MDL2.8.Sti.C	0-1103015-1	
Unterteil für Buchsenkontakte Bottom part for female contacts 	MDL2.8.Bu.C		0-1103015-2

Passende Crimpkontakte siehe Seite 38, Passende Crimpwerkzeuge siehe Seite 38
Suitable Crimp contacts see page 38 Suitable Crimping tools see page 38

Maßbild mm
Dimensions mm

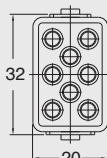

Kontaktanordnung Anschlußseite: Oberteil
Contact arrangement termination side: top part

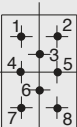

Kontaktanordnung Anschlußseite: Unterteil
Contact arrangement termination side: bottom part



HN.D-Modul/HN.D-Module

für HN.D Crimp Kontakte

for HN.D crimp contacts

Kontaktzahlen
No. of contacts

15

400V/10A

Bezeichnung Description	Bestelltext Designation	Bestell-Nr./Order No.	
		Stifteinsatz Male insert	Buchseinsatz Female insert
Oberteil für Stiftkontakte Top part for male contacts	MDL2.HN.D.15.Sti.C MDL2.HN.D.18.Sti.C	0-1103017-1 0-1103076-1	
Unterteil für Buchsenkontakte Bottom part for female contacts	MDL2.HN.D.15.Bu.C MDL2.HN.D.18.Bu.C		0-1103017-2 0-1103076-2

Passende Crimpkontakte siehe Seite 34, Passende Crimpwerkzeuge siehe Seite 34
Suitable Crimp contacts see page 34, Suitable Crimping tools see page 34

Maßbild mm Dimensions mm	Kontaktanordnung Anschlußseite: Oberteil Contact arrangement termination side: top part		Kontaktanordnung Anschlußseite: Unterteil Contact arrangement termination side: bottom part	
		<p>15 polig/pole</p>	<p>18 polig/pole</p>	<p>15 polig/pole</p>

HD-Modul/HD-Module

für HD.M Crimp Kontakte

for HD.M crimp contacts

Kontaktzahlen
No. of contacts

18

250V/10A

Bezeichnung Description	Bestelltext Designation	Bestell-Nr./Order No.	
		Stifteinsatz Male insert	Buchseinsatz Female insert
Oberteil für Stiftkontakte Top part for male contacts	MDL2.HD.18.Sti.C	0-1103016-1	
Unterteil für Buchsenkontakte Bottom part for female contacts	MDL2.HD.18.Bu.C		0-1103016-2

Passende Crimpkontakte siehe Seite 35, Fiberkontakte siehe Seite 44, Passende Crimpwerkzeuge siehe Seite 35 + 44
Suitable Crimp contacts see page 35, Suitable fiber contacts see page 44, Suitable Crimping tools see page 35 + 44

Maßbild mm Dimensions mm	Kontaktanordnung Anschlußseite: Oberteil Contact arrangement termination side: top part		Kontaktanordnung Anschlußseite: Unterteil Contact arrangement termination side: bottom part	

Dynamic 2800 Modul/Dynamic 2800 Module



für Dynamic Kontakte
for Dynamic contacts

Kontaktzahlen
No. of contacts
30

250V/5A

Bezeichnung Description	Bestelltext Designation	Bestell-Nr./Order No.	
		Stifteinsatz Male insert	Buchseinsatz Female insert
Oberteil für Stiftkontakte Top part for male contacts 	Dynamic D-2800 Rec Hsg 30p	0-1747365-1	
Unterteil für Buchsenkontakte Bottom part for female contacts 	Dynamic D-2800 Tab Hsg 30p		0-1747366-1

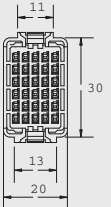
Passende Kontakte siehe Seite 33, Passende Werkzeuge siehe Seite 33
Suitable Contacts see page 33, Suitable tools see page 33

Maßbild mm Dimensions mm	Kontaktanordnung Anschlußseite: Oberteil Contact arrangement termination side: top part	Kontaktanordnung Anschlußseite: Unterteil Contact arrangement termination side: bottom part
		

Dynamic 3800 Modul/Dynamic 3800 Module



für Dynamic Kontakte
for Dynamic contacts

Kontaktzahlen
No. of contacts
12

600V/8A

Bezeichnung Description	Bestelltext Designation	Bestell-Nr./Order No.	
		Stifteinsatz Male insert	Buchseinsatz Female insert
Oberteil für Stiftkontakte Top part for male contacts 	Dynamic D-3800	0-1747363-1	
Unterteil für Buchsenkontakte Bottom part for female contacts 	Dynamic D-3800		0-1747364-1

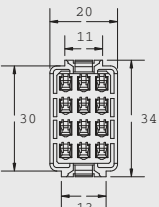
Passende Kontakte siehe Seite 33, Passende Werkzeuge siehe Seite 33
Suitable Contacts see page 33, Suitable tools see page 33

Maßbild mm Dimensions mm	Kontaktanordnung Anschlußseite: Oberteil Contact arrangement termination side: top part	Kontaktanordnung Anschlußseite: Unterteil Contact arrangement termination side: bottom part
		

Verbindlich für Toleranzen der Abmessungen und technische Werte sind ausschließlich die neuesten TE Connectivity Kundenzeichnungen bzw. Produkt-Spezifikationen, die Sie auf Anfrage erhalten.
All specifications subject to change. Consult TE Connectivity for latest design specifications.

Twinax-Modul/Twinax-Module

für HVT Kontakte
for HVT contacts

Kontaktzahlen
No. of contacts

4

150V/16A

Bezeichnung Description	Bestelltext Designation	Bestell-Nr./Order No.	
		Stifteinsatz Male insert	Buchseinsatz Female insert
Oberteil für Stiftkontakte Top part for male contacts 	MDL2.TX4.5,4.Sti.C	0-1103023-1	
	MDL2.TX4.8,5.Sti.C	0-1103022-1	
	MDL2.TX.MVB.Sti.C	0-1108785-1	
	MDL2.TX4.5,4.Bu.C		0-1103023-2
	MDL2.TX4.8,5.Bu.C		0-1103022-2
	MDL2.TX.MVB.Bu.C		0-1108786-1

Passende Crimpkontakte siehe Seite 38, Passende Crimpwerkzeuge siehe Seite 38
Suitable Crimp contacts see page 38, Suitable Crimping tools see page 38

Maßbild mm
Dimensions mm



Kontaktanordnung Anschlußseite: Oberteil
Contact arrangement termination side: top part

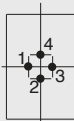

Kontaktanordnung Anschlußseite: Unterteil
Contact arrangement termination side: bottom part

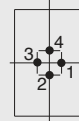

Koax-Modul/Coax-Module

für Coax Crimp Kontakte
for Coax crimp contacts

Kontaktzahlen
No. of contacts

6

Bezeichnung Description	Bestelltext Designation	Bestell-Nr./Order No.	
		Stifteinsatz Male insert	Buchseinsatz Female insert
Oberteil für Stiftkontakte Top part for male contacts 	MDL2.KX.58/59.Sti	0-1103021-1	
	MDL2.KX.58/59.Bu		0-1103021-2

Passende Kontakte siehe Seite 43, Passende Werkzeuge siehe Seite 43
Suitable contacts see page 43, Suitable tools see page 41

Maßbild mm
Dimensions mm

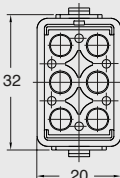

Kontaktanordnung Anschlußseite: Oberteil
Contact arrangement termination side: top part

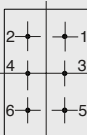

Kontaktanordnung Anschlußseite: Unterteil
Contact arrangement termination side: bottom part

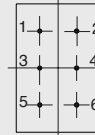

Koax-VT-Modul/Coax-VT-Module

**Kontaktzahlen
No. of contacts**

1

Bezeichnung Description	Bestelltext Designation	Bestell-Nr./Order No.	
		Stifteinsatz Male insert	Buchseinsatz Female insert
Oberteil für Stiftkontakte Top part for male contacts	MDL2.KX.VT.Sti	0-1103020-1	
Unterteil für Buchsenkontakte Bottom part for female contacts	MDL2.KX.VT.Bu		0-1103020-2

Passende Coax Kontakte siehe Seite 43 (Typ KX.VT)
Suitable Coax contacts see page 43 (Type KX.VT)

Maßbild mm
Dimensions mm

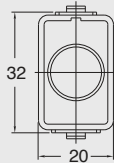

**Kontaktzahlen
No. of contacts**

8

Ethernet Anwendung mit RJ45/Ethernet application with RJ45

Bezeichnung Description	Bestelltext Designation	Bestell-Nr./Order No.	
		Jack	Plug
Oberteil/Top part	MDL2.45.Jack.5e* MDL2.45.Jack.2**	0-1108812-1 0-1108812-2	
Unterteil/Bottom part	MDL2.45.Plug		0-1108813-1
	MJ Plug ,Cat5		5-569550-4

*CAT5e
**CAT2

Passendes Werkzeug: 1-853400-0
Suitable tool: 1-853400-0

Pneumatik Modul/Pneumatic Module

10 bar

**Kontaktzahlen
No. of contacts**

2 + 2

Bezeichnung Description	Bestelltext Designation	Bestell-Nr./Order No.	
		Stifteinsatz Male insert	Buchseinsatz Female insert
Oberteil/Top part	MDL2-AIR.Sti*	0-1103025-1	
Unterteil/Bottom part	MDL2-AIR.Bu*		0-1103025-2
Kontakte/contacts	AIR.Sti.4mm,VA	0-1105354-1	
	AIR.Bu.V4VA mit Ventil/with valve		0-1105355-1
	AIR.Bu.4VA ohne Ventil/without valve		0-1105355-2
Ausdrückwerkzeug/Extraction tool	Ausdrückwerkzeug		0-1102985-1

Maßbild mm Dimensions mm	Kontaktanordnung Anschlußseite: Oberteil Contact arrangement termination side: top part	Kontaktanordnung Anschlußseite: Unterteil Contact arrangement termination side: bottom part

Erdmodul/Earth-Module, Blindmodul/Blind-Module

Bezeichnung Description	Bestelltext Designation	Bestell-Nr./Order No.	
		Oberteil Top part	Unterteil Bottom part
Blindmodul/Blind module Modulkörper für Erdkontaktierung (für Stift und Buchse verwendbar) Modular block for earth Passende Kontakte siehe Seite 42 Suitable contacts see page 42 	MDL.E.C-6mm		0-1110957-1
	MDL2.Blindmodul		0-1103014-1

Modul Halterahmen/Module Fixing Frame

Baugröße/Size 3/4

**Bezeichnung
Description**

**Bestelltext
Designation**

**Bestell-Nr./Order No.
Oberteil
Top part** **Unterteil
Bottom part**

Halterahmen/Fixing frame



Für Modul MDL Seite 194–203
For module MDL page 194–203

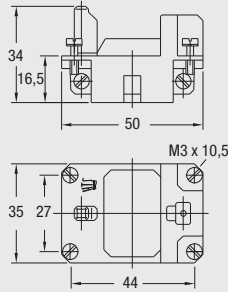

Montageausschnitt/Panel cut-out

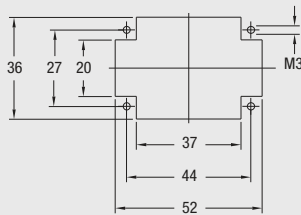

MDL2-GR.0/U-3

0-1108784-1

0-1108784-1

Halterahmen/Fixing frame



Für Modul MDL Seite 194–203
For module MDL page 194–203

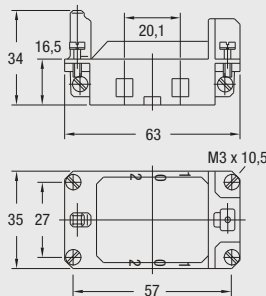

Montageausschnitt/Panel cut-out

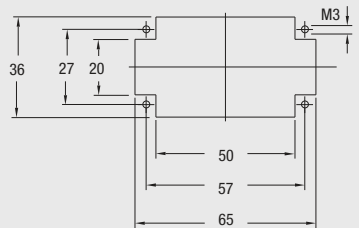

MDL2-GR.0-4/B.1-2
MDL2-GR.U-4/B.1-2

0-1108783-1

0-1108783-2

Modul Halterahmen/Module Fixing Frame

Baugröße/Size 6/8

**Bezeichnung
Description**

Halterahmen/Fixing frame

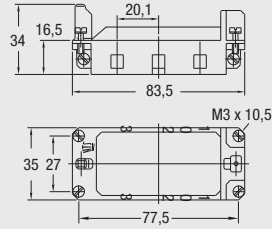

MDL2-GR.0-6/B.1-3

0-1108782-1

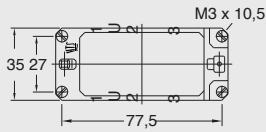

MDL2-GR.U-6/B.1-3

0-1108782-2

Montageausschnitt/Panel cut-out

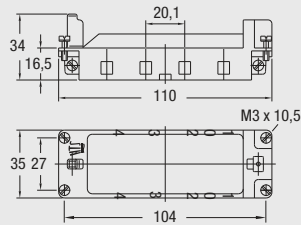
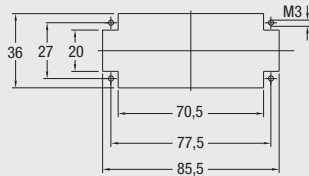

MDL2-GR.0-8/B.1-4

0-1108780-1

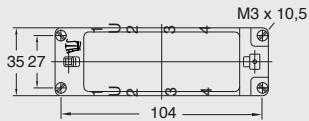

MDL2-GR.U-8/B.1-4

0-1108780-2

Montageausschnitt/Panel cut-out

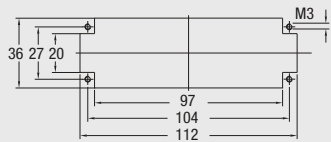

Modul Halterahmen/Module Fixing Frame

Baugröße/Size 10/12

**Bezeichnung
Description**

Halterahmen/Fixing frame

**Bestelltext
Designation**

Bestell-Nr./Order No.
Oberteil
Top part
Unterteil
Bottom part

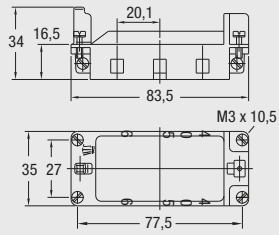

MDL2-GR.O-6/B.1-3
MDL2-GR.O-6/B.4-6

0-1108782-1
0-1108782-4

Montageausschnitt/Panel cut-out

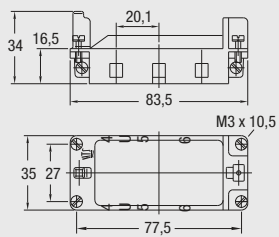
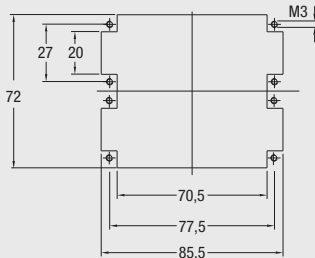

MDL2-GR.U-6/B.1-3
MDL2-GR.U-6/B.4-6

0-1108782-2
0-1108782-5

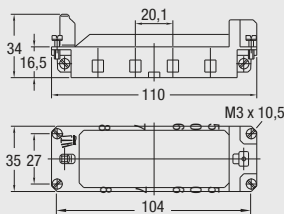

MDL2-GR.O-8/B.1-4
MDL2-GR.O-8/B.5-8

0-1108780-1
0-1108780-6

Montageausschnitt/Panel cut-out

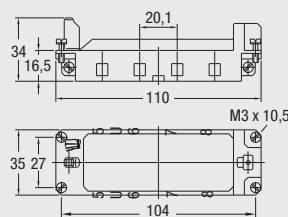
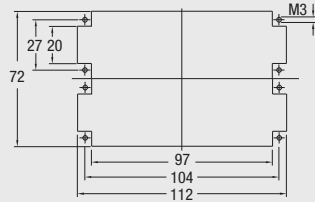

MDL2-GR.U-8/B.1-4
MDL2-GR.U-8/B.5-8

0-1108780-2
0-1108780-7

HVS-HSS-Modul/HVS-HSS-Module



für HSS Crimp Kontakte
for HSS crimp contacts

Kontaktzahlen
No. of contacts
2

500V/63A

Bezeichnung Description	Bestelltext Designation	Bestell-Nr./Order No.	
		Stifteinsatz Male insert	Buchseinsatz Female insert
Oberteil für Stiftkontakte Top part for male contacts 	HVS-HSS.2.Sti.C	0-1103275-1	
Unterteil für Buchsenkontakte Bottom part for female contacts 	HVS-HSS.2.Bu.C		0-1103274-1

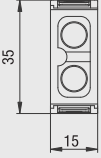
Passende Crimpkontakte siehe Seite 41, Passende Crimpwerkzeuge siehe Seite 41
Suitable Crimp contacts see page 41, Suitable Crimping tools see page 41

Maßbild mm Dimensions mm	Kontaktanordnung Anschlußseite: Oberteil Contact arrangement termination side: top part	Kontaktanordnung Anschlußseite: Unterteil Contact arrangement termination side: bottom part
		

HVS-HSK-Modul/HVS-HSK-Module



für HSK Crimp Kontakte
for HSK crimp contacts

Kontaktzahlen
No. of contacts
2

1000V/40A

Bezeichnung Description	Bestelltext Designation	Bestell-Nr./Order No.	
		Stifteinsatz Male insert	Buchseinsatz Female insert
Oberteil für Stiftkontakte Top part for male contacts 	HVS-HSK.2.Sti.C	0-1103270-1	
Unterteil für Buchsenkontakte Bottom part for female contacts 	HVS-HSK.2.Bu.C		0-1103271-1

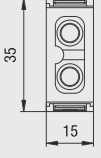
Passende Crimpkontakte siehe Seite 39, Passende Crimpwerkzeuge siehe Seite 39
Suitable Crimp contacts see page 39, Suitable Crimping tools see page 39

Maßbild mm Dimensions mm	Kontaktanordnung Anschlußseite: Oberteil Contact arrangement termination side: top part	Kontaktanordnung Anschlußseite: Unterteil Contact arrangement termination side: bottom part
		

HVS-HSK-Modul/HVS-HSK-Module

für HSK Crimp Kontakte
for HSK crimp contacts

Kontaktzahlen
No. of contacts

3

690V/40A

Bezeichnung Description	Bestelltext Designation	Bestell-Nr./Order No.	
		Stifteinsatz Male insert	Buchseinsatz Female insert
Oberteil für Stiftkontakte Top part for male contacts 	HVS-HSK.3.Sti.C	0-1103272-1	0-1103273-1
Unterteil für Buchsenkontakte Bottom part for female contacts 	HVS-HSK.3.Bu.C		

Passende Crimpkontakte siehe Seite 39, Passende Crimpwerkzeuge siehe Seite 39
Suitable Crimp contacts see page 39, Suitable Crimping tools see page 39

Maßbild mm
Dimensions mm

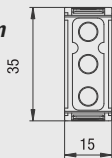

Kontaktanordnung Anschlußseite: Oberteil
Contact arrangement termination side: top part



Kontaktanordnung Anschlußseite: Unterteil
Contact arrangement termination side: bottom part



HVS-HE 5-Modul/HVS-HE 5-Module

für HE Spring Clamp Kontakte
for HE spring clamp contacts

Kontaktzahlen
No. of contacts

5

400V/16A

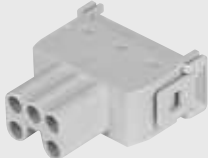
Bezeichnung Description	Bestelltext Designation	Bestell-Nr./Order No.	
		Stifteinsatz Male insert	Buchseinsatz Female insert
Oberteil für Stiftkontakte Top part for male contacts 	HVS-HE.5.Sti.SC	0-1103133-1	0-1103134-1
Unterteil für Buchsenkontakte Bottom part for female contacts 	HVS-HE.5.Bu.SC		

Maßbild mm
Dimensions mm

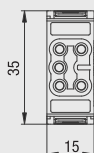

Kontaktanordnung Anschlußseite: Oberteil
Contact arrangement termination side: top part



Kontaktanordnung Anschlußseite: Unterteil
Contact arrangement termination side: bottom part





HVS-HE 6-Modul/HVS-HE 6-Module

für HE Crimp Kontakte
for HE crimp contacts



Kontaktzahlen
No. of contacts

6

500V/16A

Bezeichnung Description	Bestelltext Designation	Bestell-Nr./Order No.	
		Stifteinsatz Male insert	Buchseinsatz Female insert
Oberteil für Stiftkontakte Top part for male contacts 	HVS-HE.6.Sti.C	0-1103244-1	
Unterteil für Buchsenkontakte Bottom part for female contacts 	HVS-HE.6.Bu.C		0-1103245-1

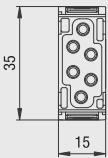
Passende Crimpkontakte siehe Seite 37, Passende Crimpwerkzeuge siehe Seite 37
Suitable Crimp contacts see page 37, Suitable Crimping tools see page 37

Maßbild mm Dimensions mm	Kontaktanordnung Anschlußseite: Oberteil Contact arrangement termination side: top part	Kontaktanordnung Anschlußseite: Unterteil Contact arrangement termination side: bottom part
		

HVS-HE 8-Modul/HVS-HE 8-Module

für HE Crimp Kontakte
for HE crimp contacts



Kontaktzahlen
No. of contacts

8

400V/16A

Bezeichnung Description	Bestelltext Designation	Bestell-Nr./Order No.	
		Stifteinsatz Male insert	Buchseinsatz Female insert
Oberteil für Stiftkontakte Top part for male contacts 	HVS-HE.8.Sti.C	0-1103140-1	
Unterteil für Buchsenkontakte Bottom part for female contacts 	HVS-HE.8.Bu.C		0-1103141-1

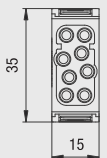
Passende Crimpkontakte siehe Seite 37, Passende Crimpwerkzeuge siehe Seite 37
Suitable Crimp contacts see page 37, Suitable Crimping tools see page 37

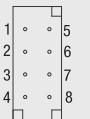
Maßbild mm Dimensions mm	Kontaktanordnung Anschlußseite: Oberteil Contact arrangement termination side: top part	Kontaktanordnung Anschlußseite: Unterteil Contact arrangement termination side: bottom part
		

HVS-HE 20-Modul/HVS-HE 20-Module

für HE Crimp Kontakte
for HE crimp contacts

Kontaktzahlen
No. of contacts

20

500V/16A

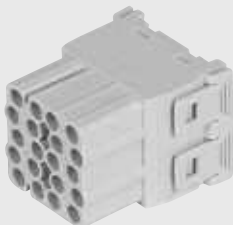
Bezeichnung Description	Bestelltext Designation	Bestell-Nr./Order No.	
		Stifteinsatz Male insert	Buchseneinsatz Female insert
Oberteil für Stiftkontakte Top part for male contacts 	HVS-HE.20.Sti.C	0-1103144-1	
Unterteil für Buchsenkontakte Bottom part for female contacts 	HVS-HE.20.Bu.C		0-1103145-1

Passende Crimpkontakte siehe Seite 37, Passende Crimpwerkzeuge siehe Seite 37
Suitable Crimp contacts see page 37, Suitable Crimping tools see page 37

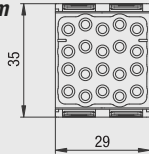
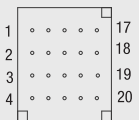
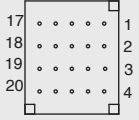
Maßbild mm Dimensions mm	Kontaktanordnung Anschlußseite: Oberteil Contact arrangement termination side: top part	Kontaktanordnung Anschlußseite: Unterteil Contact arrangement termination side: bottom part
		



HVS-HN.D.12-Modul/HVS-HN.D.12-Module

für HN.D Crimp Kontakte
for HN.D crimp contacts

Kontaktzahlen
No. of contacts

12

250V/10A

Bezeichnung Description	Bestelltext Designation	Bestell-Nr./Order No.	
		Stifteinsatz Male insert	Buchseneinsatz Female insert
Oberteil für Stiftkontakte Top part for male contacts 	HVS-HN.D.12.Sti.C	0-1103277-1	
Unterteil für Buchsenkontakte Bottom part for female contacts 	HVS-HN.D.12.Bu.C		0-1103276-1

Passende Crimpkontakte siehe Seite 34, Passende Crimpwerkzeuge siehe Seite 34
Suitable Crimp contacts see page 34, Suitable Crimping tools see page 34

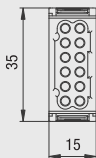
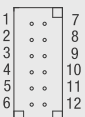
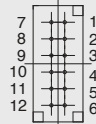
Maßbild mm Dimensions mm	Kontaktanordnung Anschlußseite: Oberteil Contact arrangement termination side: top part	Kontaktanordnung Anschlußseite: Unterteil Contact arrangement termination side: bottom part
		

HVS-HN.D.17-Modul/HVS-HN.D.17-Module



für HN.D Crimp Kontakte
for HN.D crimp contacts

Kontaktzahlen
No. of contacts
17

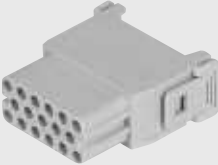
250V/10A

Bezeichnung Description	Bestelltext Designation	Bestell-Nr./Order No.	
		Stifteinsatz Male insert	Buchseinsatz Female insert
Oberteil für Stiftkontakte Top part for male contacts 	HVS-HN.D.17.Sti.C	0-1103278-1	
Unterteil für Buchsenkontakte Bottom part for female contacts 	HVS-HN.D.17.Bu.C		0-1103279-1

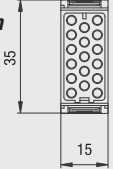
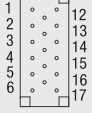
Passende Crimpkontakte siehe Seite 34, Passende Crimpwerkzeuge siehe Seite 34
Suitable Crimp contacts see page 34, Suitable Crimping tools see page 34

Maßbild mm Dimensions mm	Kontaktanordnung Anschlußseite: Oberteil Contact arrangement termination side: top part	Kontaktanordnung Anschlußseite: Unterteil Contact arrangement termination side: bottom part
		

HVS-MM.17-Modul/HVS-MM.17-Module

für HD Crimp Kontakte, POF Optische Kontakte
for HD crimp contacts, POF Fiber contacts

Kontaktzahlen
No. of contacts
17

250V/10A

Bezeichnung Description	Bestelltext Designation	Bestell-Nr./Order No.	
		Stifteinsatz Male insert	Buchseinsatz Female insert
Oberteil für Stiftkontakte Top part for male contacts 	HVS-MM.17.Sti.C	0-1103280-1	
Unterteil für Buchsenkontakte Bottom part for female contacts 	HVS-MM.17.Bu.C		0-1103281-1

Passende Crimpkontakte siehe Seite 35 + 44, Passende Crimpwerkzeuge siehe Seite 35 + 44
Suitable Crimp contacts see page 35 + 44, Suitable Crimping tools see page 35 + 44

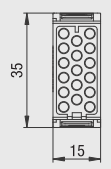
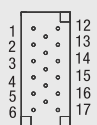
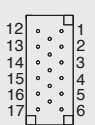
Maßbild mm Dimensions mm	Kontaktanordnung Anschlußseite: Oberteil Contact arrangement termination side: top part	Kontaktanordnung Anschlußseite: Unterteil Contact arrangement termination side: bottom part
		

HVS-S20 DF-Modul/HVS-S20 DF-Module

für Sub D Crimp Kontakte
for Sub D crimp contacts

Kontaktzahlen
No. of contacts
25

50V/5A

Bezeichnung Description	Bestelltext Designation	Bestell-Nr./Order No.	
		Stifteinsatz Male insert	Buchseinsatz Female insert
Oberteil für Stiftkontakte Top part for male contacts	HVS-S20DF.25.Sti.C	0-1103260-1	
Unterteil für Buchsenkontakte Bottom part for female contacts	HVS-S20DF.25.Bu.C		0-1103261-1

Passende Crimpkontakte siehe Seite 32, Passende Crimpwerkzeuge siehe Seite 32
Suitable Crimp contacts see page 32, Suitable Crimping tools see page 32

Maßbild mm
Dimensions mm

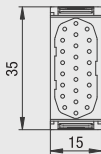

Kontaktanordnung Anschlußseite: Oberteil
Contact arrangement termination side: top part

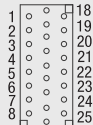

Kontaktanordnung Anschlußseite: Unterteil
Contact arrangement termination side: bottom part

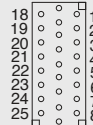

HVS-TX-Modul/HVS-TX-Module

für HN.D Crimp Kontakte
for HN.D crimp contacts

Kontaktzahlen
No. of contacts
2

50V/10A, 50V/5A

Bezeichnung Description	Bestelltext Designation	Bestell-Nr./Order No.	
		Stifteinsatz Male insert	Buchseinsatz Female insert
Oberteil für Stiftkontakte Top part for male contacts	HVS-TX.2.Sti	0-1103267-1	
Unterteil für Buchsenkontakte Bottom part for female contacts	HVS-TX.HN.D.4.Sti.C		0-1103283-1
	HVS-TX.S20DF.8.Sti.C		0-1103291-1
	HVS-TX.2.Bu		0-1103269-1
	HVS-TX.HN.D.4.Bu.C		0-1103286-1
	HVS-TX.S20DF.8.Bu.C		0-1103297-1

Passende HN.D Crimpkontakte siehe Seite 34, passende S20DF Crimpkontakte siehe Seite 32, Passende Crimpwerkzeuge siehe Seite 32/34
Suitable HN.D Crimp contacts see page 34, suitable S20DF Crimp contacts see page 32, Suitable Crimping tools see page 32/34

Maßbild mm
Dimensions mm

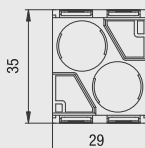

Kontaktanordnung Anschlußseite: Oberteil
Contact arrangement termination side: top part

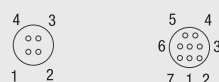

Kontaktanordnung Anschlußseite: Unterteil
Contact arrangement termination side: bottom part

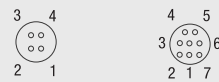

HVS-MVB-Modul/HVS-MVB-Module

für HN.D Crimp Kontakte
for HN.D crimp contacts

Kontaktzahlen
No. of contacts
4/8

50V/10A, 50V/5A

Bezeichnung Description	Bestelltext Designation	Bestell-Nr./Order No.	
		Stifteinsatz Male insert	Buchseinsatz Female insert
Oberteil für Stiftkontakte Top part for male contacts	HVS-MVB.HND.4.Sti.C HVS-MVB.S20DF.8.Sti.C	0-1103251-1 0-1103258-1	
Unterteil für Buchsenkontakte Bottom part for female contacts	HVS-MVB.HND.4.Bu.C HVS-MVB.S20DF.8.Bu.C		0-1103253-1 0-1103259-1

Passende HN.D Crimpkontakte siehe Seite 34, passende S20DF Crimpkontakte siehe Seite 32, Passende Crimpwerkzeuge siehe Seite 32/34
Suitable HN.D Crimp contacts see page 34, suitable S20DF Crimp contacts see page 32, Suitable Crimping tools see page 32/34

Maßbild mm Dimensions mm	Kontaktanordnung Anschlußseite: Oberteil Contact arrangement termination side: top part	Kontaktanordnung Anschlußseite: Unterteil Contact arrangement termination side: bottom part

HVS-Air-Modul/HVS-Air-Module

für Air Kontakte
for Air contacts

Kontaktzahlen
No. of contacts
2

10 bar

Bezeichnung Description	Bestelltext Designation	Bestell-Nr./Order No.	
		Stifteinsatz Male insert	Buchseinsatz Female insert
Oberteil für Stiftkontakte Top part for male contacts	HVS-Air.2.Sti	0-1103246-1	
Unterteil für Buchsenkontakte Bottom part for female contacts	HVS-Air.2.Bu		0-1103247-1

Passende Kontakte siehe Seite 200
Suitable Contacts see page 200

Maßbild mm Dimensions mm	Kontaktanordnung Anschlußseite: Oberteil Contact arrangement termination side: top part	Kontaktanordnung Anschlußseite: Unterteil Contact arrangement termination side: bottom part

Blindmodul/Blind-Module

**Bezeichnung
Description**

Blindmodul/Blind module

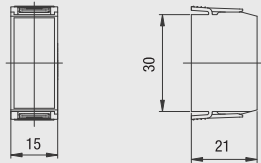

**Bestelltext
Designation**

HVS-Blindmodul

Bestell-Nr./Order No.

0-1103266-1

Modul Halterahmen/Module Fixing Frame

Baugröße/Size 3/4

**Bezeichnung
Description**

Halterahmen/Fixing frame

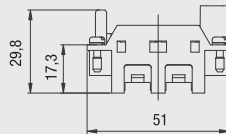

HVS-R.0 1-2

0-1103250-7

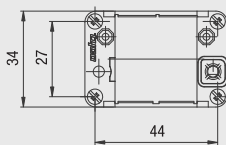

HVS-R.U 1-2

0-1103250-8

Montageausschnitt/Panel cut-out

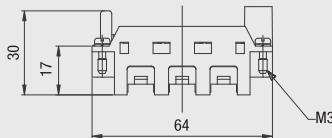
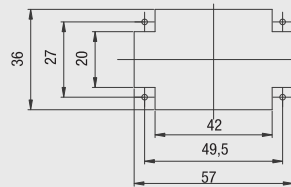

HVS-R.0 1-3

0-1103250-5

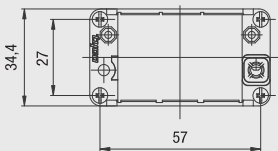

HVS-R.U 1-3

0-1103250-6

Montageausschnitt/Panel cut-out

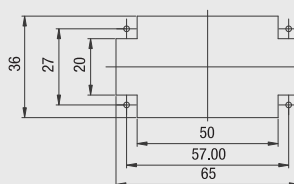

Modul Halterahmen/Module Fixing Frame

Baugröße/Size 6/8

**Bezeichnung
Description**

Halterahmen/Fixing frame

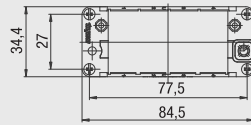
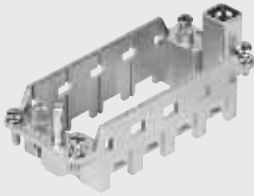

Montageausschnitt/Panel cut-out

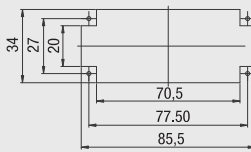

HVS-R.0 1-4

0-1103250-3

HVS-R.U 1-4

0-1103250-4

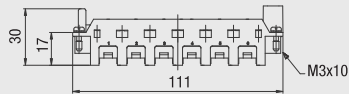
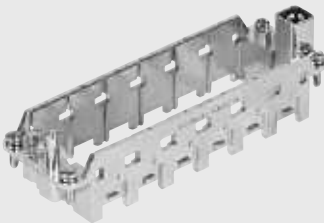

Montageausschnitt/Panel cut-out

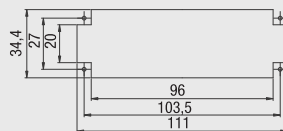

HVS-R.0 1-6

0-1103250-1

HVS-R.U 1-6

0-1103250-2

Kodierset für Modulrahmen Serie HVS mit 36 Kodiemöglichkeiten
Coding set for Module fixing frames Series HVS with 36 coding possibilities



Codeset HVS

530341-1

Schirmkontaktbügel/Screen termination

zur nachträglichen Montage am Modulrahmen Serie MDL.2

or post-assembly on Module fixing frame series MDL.2

Bezeichnung Description	Maßbild mm Dimensions mm	Bestelltext Designation	Bestell-Nr. Order No.
 Schirmkontaktbügel, schwenkbar Screen termination, rotatable	 Maß/Measure mm E F		
Baugröße/Size 3	45,4 36	MDL.2-SBS.Bg3	2-1106310-9
Baugröße/Size 4	45,4 52	MDL.2-SBS.Bg4	2-1106311-9
Baugröße/Size 6	45,4 72,5	MDL.2-SBS.Bg6	2-1106312-9
Baugröße/Size 8	53,9 96	MDL.2-SBS.Bg8	2-1106313-9

Zubehör für Schirmkontaktbügel/Accessories for screen termination

Schellenset Cable clamp 	Schellenset/Cable clamp 4,5mm 5mm 6mm 7mm 8mm 9mm 10mm	1-1106302-9 2-1106302-9 3-1106302-9 4-1106302-9 5-1106302-9 6-1106302-9 7-1106302-9
Erdungsband Grounding terminal 	Erdungsband Grounding terminal Set 90mm Set 120mm Set 220mm	1-1106303-9 2-1106303-9 3-1106303-9
Schrauben-Set Screw set 	Schrauben-Set/Screw set	1-1106304-9

Sortiert nach Tyco-PN/Sorted by Tyco PN

Best-Nr.	Seite	Best-Nr.	Seite	Best-Nr.	Seite	Best-Nr.	Seite	Best-Nr.	Seite	Best-Nr.	Seite
0-0045740-2	43	0-1102897-2	82	0-1103170-2	51	0-1106407-2	54	0-1106431-3	90	0-1106451-8	116
0-0090364-2	44	0-1102898-1	82	0-1103171-1	51	0-1106408-1	53	0-1106431-4	96	0-1106451-9	124
0-0100281-1	44	0-1102898-2	82	0-1103171-2	51	0-1106408-2	53	0-1106431-5	87	0-1106452-1	116
0-0100281-2	44	0-1102899-1	73	0-1103172-1	52	0-1106408-3	53	0-1106431-7	90	0-1106452-2	120
0-0100606-2	44	0-1102918-1	67	0-1103172-2	52	0-1106409-1	65	0-1106431-7	92	0-1106452-3	118
0-0163083-7	35	0-1102918-2	67	0-1103173-1	52	0-1106410-1	65	0-1106431-8	96	0-1106452-4	115
0-0164160-4	35	0-1102919-1	67	0-1103173-2	52	0-1106410-2	64	0-1106432-1	94	0-1106452-5	120
0-0164161-4	35	0-1102919-2	67	0-1103174-1	52	0-1106411-1	63	0-1106432-2	89	0-1106452-6	118
0-0164161-9	35	0-1102920-1	116	0-1103174-2	52	0-1106411-2	63	0-1106432-3	94	0-1106452-7	116
0-0166824-2	35	0-1102921-1	44	0-1103176-1	184	0-1106411-6	63	0-1106432-4	89	0-1106452-8	120
0-0216341-1	44	0-1102978-2	177	0-1103176-2	184	0-1106412-1	65	0-1106433-1	91	0-1106452-9	118
0-0216342-1	44	0-1102983-1	150	0-1103244-1	206	0-1106413-1	65	0-1106433-2	94	0-1106453-1	126
0-0305183-8	43	0-1102985-1	200	0-1103245-1	206	0-1106413-2	64	0-1106433-3	93	0-1106454-1	125
0-0501198-1	44	0-1103014-1	200	0-1103246-1	210	0-1106414-1	63	0-1106433-4	88	0-1106454-2	125
0-0539744-2	35	0-1103015-1	195	0-1103247-1	210	0-1106414-2	63	0-1106433-5	91	0-1106455-1	131
0-0734423-1	44	0-1103015-2	195	0-1103250-1	138	0-1106415-2	80	0-1106433-6	94	0-1106455-2	130
0-1102075-1	113	0-1103016-1	196	0-1103250-1	212	0-1106415-3	80	0-1106433-7	93	0-1106456-1	130
0-1102076-1	113	0-1103016-2	196	0-1103250-2	171	0-1106416-3	79	0-1106433-8	88	0-1106456-2	131
0-1102077-1	137	0-1103017-1	196	0-1103250-2	212	0-1106416-4	79	0-1106434-1	87	0-1106456-3	130
0-1102081-1	182	0-1103017-2	196	0-1103250-3	114	0-1106417-1	76	0-1106434-2	92	0-1106456-4	131
0-1102082-1	182	0-1103018-1	195	0-1103250-3	212	0-1106417-2	76	0-1106434-3	90	0-1106459-1	130
0-1102192-1	176	0-1103018-2	195	0-1103250-4	171	0-1106418-1	75	0-1106434-4	87	0-1106459-2	131
0-1102192-2	176	0-1103019-1	194	0-1103250-4	212	0-1106418-2	74	0-1106434-5	92	0-1106459-3	130
0-1102194-1	46	0-1103019-2	194	0-1103250-5	86	0-1106418-3	75	0-1106434-6	90	0-1106459-4	131
0-1102195-1	46	0-1103020-1	199	0-1103250-5	211	0-1106418-4	74	0-1106434-7	87	0-1106460-2	151
0-1102677-1	137	0-1103020-2	199	0-1103250-6	159	0-1106418-5	78	0-1106434-8	92	0-1106461-3	150
0-1102789-1	39	0-1103021-1	198	0-1103250-6	211	0-1106418-6	78	0-1106434-9	90	0-1106461-4	150
0-1102790-1	39	0-1103021-2	198	0-1103250-7	72	0-1106419-1	73	0-1106435-1	99	0-1106461-8	150
0-1102792-1	150	0-1103022-1	198	0-1103250-7	201	0-1106419-2	73	0-1106436-1	98	0-1106462-2	150
0-1102836-1	176	0-1103022-2	198	0-1103250-7	211	0-1106419-3	73	0-1106436-2	98	0-1106463-1	147
0-1102836-2	176	0-1103023-1	198	0-1103250-8	159	0-1106419-4	73	0-1106436-3	98	0-1106463-2	141
0-1102837-1	176	0-1103023-2	198	0-1103250-8	201	0-1106419-5	77	0-1106436-4	98	0-1106463-3	147
0-1102837-2	176	0-1103024-1	194	0-1103250-8	211	0-1106419-6	77	0-1106436-5	98	0-1106464-1	143
0-1102838-1	176	0-1103024-2	194	0-1103251-1	210	0-1106420-1	73	0-1106436-6	98	0-1106464-2	146
0-1102838-2	176	0-1103025-1	200	0-1103251-2	210	0-1106420-2	77	0-1106437-1	105	0-1106464-3	146
0-1102839-1	176	0-1103025-2	200	0-1103260-1	209	0-1106420-3	77	0-1106438-1	105	0-1106464-4	141
0-1102839-3	176	0-1103028-1	189	0-1103261-1	209	0-1106421-1	76	0-1106438-2	104	0-1106464-5	143
0-1102839-4	176	0-1103028-2	189	0-1103266-1	211	0-1106421-2	76	0-1106439-1	103	0-1106464-6	146
0-1102840-1	176	0-1103070-1	55	0-1103267-1	209	0-1106421-3	75	0-1106439-2	103	0-1106464-7	146
0-1102840-2	176	0-1103071-1	55	0-1103269-1	209	0-1106422-2	75	0-1106440-1	105	0-1106464-8	141
0-1102840-3	176	0-1103072-1	57	0-1103270-1	204	0-1106422-3	75	0-1106441-1	105	0-1106465-1	140
0-1102840-4	176	0-1103072-2	57	0-1103271-1	204	0-1106422-4	75	0-1106441-2	104	0-1106465-2	145
0-1102855-1	35	0-1103073-1	56	0-1103272-1	205	0-1106422-5	78	0-1106442-1	103	0-1106465-3	142
0-1102855-1	44	0-1103073-2	56	0-1103273-1	205	0-1106423-1	74	0-1106442-2	103	0-1106465-4	139
0-1102855-2	34	0-1103073-3	56	0-1103274-1	204	0-1106423-2	73	0-1106443-1	126	0-1106465-5	144
0-1102855-3	38	0-1103073-4	56	0-1103275-1	204	0-1106423-3	74	0-1106444-1	125	0-1106465-6	142
0-1102855-4	40	0-1103074-1	59	0-1103276-1	207	0-1106423-4	73	0-1106444-2	125	0-1106465-7	140
0-1102855-5	41	0-1103074-2	59	0-1103277-1	207	0-1106423-5	77	0-1106445-2	126	0-1106465-8	145
0-1102855-6	34	0-1103074-3	59	0-1103278-1	208	0-1106424-1	80	0-1106446-3	125	0-1106466-7	148
0-1102855-6	35	0-1103074-4	59	0-1103279-1	208	0-1106424-2	80	0-1106446-4	125	0-1106466-8	148
0-1102855-6	37	0-1103074-5	59	0-1103280-1	208	0-1106425-1	79	0-1106447-1	122	0-1106467-1	140
0-1102855-6	38	0-1103074-6	59	0-1103281-1	208	0-1106425-2	79	0-1106447-2	117	0-1106467-4	139
0-1102855-6	39	0-1103076-1	196	0-1103283-1	209	0-1106425-3	79	0-1106447-4	117	0-1106467-5	144
0-1102855-6	40	0-1103076-2	196	0-1103286-1	209	0-1106425-4	79	0-1106448-1	119	0-1106467-7	140
0-1102855-6	44	0-1103091-1	55	0-1103291-1	209	0-1106425-6	79	0-1106448-2	122	0-1106468-1	147
0-1102855-7	37	0-1103092-1	58	0-1103297-1	209	0-1106426-2	99	0-1106448-3	121	0-1106468-2	141
0-1102855-8	39	0-1103092-2	58	0-1104700-1	113	0-1106427-3	98	0-1106448-4	116	0-1106469-1	143
0-1102856-1	--	0-1103092-3	58	0-1104701-1	113	0-1106427-4	98	0-1106448-5	119	0-1106469-2	146
0-1102858-1	--	0-1103092-4	58	0-1105354-1	200	0-1106428-1	94	0-1106448-6	122	0-1106469-3	146
0-1102860-1	--	0-1103092-5	58	0-1105355-1	200	0-1106428-2	89	0-1106448-7	121	0-1106469-4	141
0-1102862-1	--	0-1103092-6	58	0-1105355-2	200	0-1106428-4	89	0-1106448-9	116	0-1106469-5	143
0-1102874-1	50	0-1103092-7	58	0-1106062-6	192	0-1106429-1	91	0-1106449-1	115	0-1106469-6	146
0-1102877-1	153	0-1103092-8	58	0-1106062-7	192	0-1106429-2	94	0-1106449-2	120	0-1106469-7	146
0-1102877-2	153	0-1103092-9	58	0-1106258-3	185	0-1106429-3	93	0-1106449-3	118	0-1106469-8	141
0-1102879-1	154	0-1103095-1	55	0-1106258-4	185	0-1106429-4	88	0-1106449-4	115	0-1106469-9	97
0-1102879-2	154	0-1103096-1	55	0-1106259-3	185	0-1106429-5	91	0-1106449-5	120	0-1106470-1	140
0-1102886-1	133	0-1103108-1	101	0-1106259-4	185	0-1106429-6	94	0-1106449-6	118	0-1106470-2	145
0-1102886-1	170	0-1103108-2	128	0-1106401-2	54	0-1106429-7	93	0-1106449-7	115	0-1106470-3	142
0-1102886-2	170	0-1103109-1	101	0-1106401-3	54	0-1106429-8	88	0-1106449-8	120	0-1106470-4	139
0-1102886-4	133	0-1103109-2	128	0-1106401-4	54	0-1106429-9	97	0-1106449-9	118	0-1106470-5	144
0-1102887-1	133	0-1103133-1	205	0-1106402-2	53	0-1106430-1	87	0-1106450-1	122	0-1106470-6	142
0-1102887-1	170	0-1103134-1	205	0-1106402-3	53	0-1106430-2	92	0-1106450-2	117	0-1106470-7	140
0-1102887-2	170	0-1103140-1	206	0-1106403-1	50	0-1106430-3	90	0-1106450-3	122	0-1106470-8	145
0-1102887-4	133	0-1103141-1	206	0-1106404-1	50	0-1106430-4	87	0-1106450-4	117	0-1106470-9	142
0-1102892-1	48	0-1103144-1	207	0-1106404-3	50	0-1106430-5	92	0-1106451-1	119	0-1106471-9	148
0-1102893-1	48	0-1103145-1	207	0-1106405-1	49	0-1106430-6	90	0-1106451-2	122	0-1106472-1	151
0-1102895-1	107	0-1103155-1	56	0-1106405-2	46	0-1106430-7	87	0-1106451-3	121	0-1106472-2	151
0-1102895-3	107	0-1103155-2	56	0-1106405-3	49	0-1106430-8	92	0-1106451-4	116	0-1106473-1	150
0-1102896-1	107	0-1103169-1	51	0-1106406-1	49	0-1106430-9	90	0-1106451-5	119	0-1106473-2	150
0-1102896-3	107	0-1103169-2	51	0-1106406-3	49	0-1106431-1	87	0-1106451-6	122	0-1106473-3	150
0-1102897-1	82	0-1103170-1	51	0-1106407-1	54	0-1106431-2	92	0-1106451-7	121	0-1106473-4	150

Sortiert nach Tyco-PN/Sorted by Tyco PN

Best-Nr.	Seite	Best-Nr.	Seite	Best-Nr.	Seite	Best-Nr.	Seite	Best-Nr.	Seite	Best-Nr.	Seite
0-1106474-1	150	0-1108782-2	114	1-1102106-2	49	1-1102271-2	93	1-1102352-1	160	1-1102519-2	94
0-1106474-2	150	0-1108782-2	159	1-1102107-2	49	1-1102271-8	96	1-1102352-2	164	1-1102523-2	94
0-1106475-2	161	0-1108782-2	202	1-1102109-2	50	1-1102274-1	88	1-1102352-8	165	1-1102523-6	91
0-1106476-1	162	0-1108782-2	203	1-1102110-2	50	1-1102274-2	93	1-1102354-1	161	1-1102525-2	94
0-1106476-2	164	0-1108782-4	159	1-1102112-2	50	1-1102274-8	97	1-1102354-8	165	1-1102527-2	94
0-1106476-4	161	0-1108782-4	203	1-1102114-2	50	1-1102276-1	88	1-1102356-1	161	1-1102530-7	103
0-1106476-5	162	0-1108782-5	159	1-1102117-7	63	1-1102276-2	93	1-1102356-8	165	1-1102533-7	103
0-1106476-8	161	0-1108782-5	203	1-1102120-7	63	1-1102276-8	97	1-1102359-1	161	1-1102536-7	103
0-1106477-1	160	0-1108783-1	86	1-1102121-2	64	1-1102279-1	89	1-1102360-2	164	1-1102539-7	103
0-1106477-2	163	0-1108783-2	86	1-1102122-2	64	1-1102279-2	94	1-1102360-6	162	1-1102541-2	104
0-1106477-4	160	0-1108784-1	72	1-1102124-2	64	1-1102282-1	89	1-1102362-2	164	1-1102543-2	104
0-1106477-5	163	0-1108784-1	201	1-1102126-2	64	1-1102282-2	94	1-1102362-6	162	1-1102545-2	104
0-1106477-6	162	0-1108785-1	198	1-1102128-2	65	1-1102283-2	93	1-1102364-6	162	1-1102547-2	104
0-1106477-7	160	0-1108786-1	198	1-1102130-2	65	1-1102283-6	91	1-1102373-7	172	1-1102549-2	105
0-1106477-8	163	0-1108794-2	59	1-1102133-2	65	1-1102286-2	94	1-1102376-7	172	1-1102551-2	105
0-1106480-1	167	0-1108795-1	57	1-1102136-7	103	1-1102286-6	91	1-1102379-7	172	1-1102553-2	105
0-1106480-2	167	0-1108795-2	57	1-1102139-7	103	1-1102288-2	94	1-1102382-7	172	1-1102555-2	105
0-1106481-1	173	0-1108795-3	57	1-1102140-2	104	1-1102288-6	91	1-1102385-7	172	1-1102561-2	105
0-1106481-2	173	0-1108795-4	57	1-1102141-2	104	1-1102291-1	140	1-1102388-7	172	1-1102564-1	118
0-1106481-4	173	0-1108795-4	59	1-1102143-2	104	1-1102291-2	145	1-1102389-2	173	1-1102564-3	123
0-1106482-1	172	0-1108808-1	55	1-1102145-2	104	1-1102291-8	149	1-1102391-2	173	1-1102564-6	115
0-1106482-2	172	0-1108812-1	199	1-1102147-2	105	1-1102292-1	118	1-1102393-2	173	1-1102564-7	120
0-1106482-4	172	0-1108812-2	199	1-1102149-2	105	1-1102292-3	123	1-1102395-2	173	1-1102567-1	118
0-1106482-6	172	0-1108813-1	199	1-1102152-2	105	1-1102292-6	115	1-1102397-2	173	1-1102567-3	123
0-1106515-1	178	0-1110505-1	182	1-1102155-1	131	1-1102292-7	120	1-1102405-3	148	1-1102567-6	115
0-1106516-1	178	0-1110661-3	185	1-1102155-6	130	1-1102295-1	118	1-1102408-3	148	1-1102567-7	120
0-1107196-1	186	0-1110661-4	185	1-1102158-1	131	1-1102295-6	115	1-1102411-6	139	1-1102570-1	118
0-1107196-2	186	0-1110684-3	185	1-1102158-6	130	1-1102295-7	120	1-1102411-7	144	1-1102570-6	116
0-1107196-3	186	0-1110684-4	185	1-1102160-1	130	1-1102296-1	116	1-1102414-6	140	1-1102570-7	120
0-1107197-1	186	0-1110939-3	178	1-1102162-1	130	1-1102296-2	121	1-1102416-7	--	1-1102573-1	118
0-1107197-2	186	0-1110948-1	42	1-1102164-1	130	1-1102296-8	123	1-1102418-7	--	1-1102573-6	116
0-1107197-3	186	0-1110949-1	42	1-1102165-1	131	1-1102299-1	116	1-1102419-2	--	1-1102573-7	120
0-1107198-1	187	0-1110950-2	175	1-1102167-1	131	1-1102299-2	121	1-1102420-2	--	1-1102575-1	116
0-1107198-2	187	0-1110950-4	175	1-1102169-1	131	1-1102299-8	124	1-1102422-2	--	1-1102575-2	121
0-1107199-1	187	0-1110951-2	175	1-1102172-7	153	1-1102301-1	116	1-1102424-2	--	1-1102577-1	116
0-1107199-2	187	0-1110951-4	175	1-1102175-7	153	1-1102301-2	121	1-1102427-7	63	1-1102577-2	121
0-1107200-1	187	0-1110952-1	42	1-1102176-2	153	1-1102301-8	124	1-1102430-7	63	1-1102579-1	116
0-1107200-2	187	0-1110952-2	42	1-1102177-2	153	1-1102304-1	117	1-1102433-7	63	1-1102579-2	121
0-1107201-1	187	0-1110952-3	42	1-1102179-2	154	1-1102304-2	122	1-1102436-7	63	1-1102581-1	116
0-1107201-2	187	0-1110952-5	42	1-1102181-2	154	1-1102305-2	121	1-1102438-2	64	1-1102581-2	121
0-1107202-1	186	0-1110952-7	42	1-1102183-2	154	1-1102305-6	119	1-1102440-2	64	1-1102584-1	117
0-1107202-2	186	0-1110952-9	42	1-1102185-2	154	1-1102308-2	122	1-1102442-2	64	1-1102584-2	122
0-1107203-1	186	0-1110953-5	42	1-1102205-3	77	1-1102308-6	119	1-1102444-2	64	1-1102587-1	117
0-1107203-2	186	0-1110953-6	42	1-1102205-7	73	1-1102310-2	122	1-1102446-2	65	1-1102587-2	122
0-1107204-1	187	0-1110953-7	42	1-1102211-1	90	1-1102310-6	119	1-1102448-2	65	1-1102589-2	122
0-1107204-2	187	0-1110953-8	42	1-1102211-3	96	1-1102316-1	142	1-1102450-2	65	1-1102589-6	119
0-1107204-3	187	0-1110953-9	42	1-1102211-6	87	1-1102316-3	148	1-1102452-2	65	1-1102591-2	122
0-1107204-4	187	0-1110955-1	175	1-1102211-7	92	1-1102316-6	139	1-1102455-2	65	1-1102591-6	119
0-1107205-1	187	0-1110955-2	175	1-1102214-6	87	1-1102316-7	144	1-1102458-2	65	1-1102593-2	122
0-1107205-2	187	0-1110955-3	175	1-1102220-3	123	1-1102319-1	142	1-1102461-3	77	1-1102593-6	119
0-1107205-3	187	0-1110955-4	175	1-1102220-6	115	1-1102319-3	148	1-1102461-7	73	1-1102595-2	122
0-1108533-1	151	0-1110956-1	42	1-1102229-3	148	1-1102319-6	139	1-1102467-7	74	1-1102595-6	119
0-1108534-1	125	0-1110956-2	42	1-1102232-3	148	1-1102319-7	144	1-1102472-2	75	1-1102600-5	53
0-1108573-5	73	0-1110956-3	42	1-1102233-3	174	1-1102325-1	142	1-1102472-8	78	1-1102601-5	54
0-1108600-1	43	0-1110956-4	42	1-1102234-3	174	1-1102325-6	140	1-1102474-2	75	1-1102602-5	53
0-1108601-1	43	0-1110956-5	42	1-1102235-3	174	1-1102325-7	145	1-1102474-8	78	1-1102603-5	53
0-1108616-1	43	0-1110956-6	42	1-1102236-3	174	1-1102328-1	142	1-1102480-2	75	1-1102604-5	80
0-1108617-1	43	0-1110956-7	42	1-1102237-8	174	1-1102328-6	140	1-1102482-2	75	1-1102605-5	80
0-1108628-1	43	0-1110957-1	200	1-1102240-3	77	1-1102328-7	145	1-1102489-2	76	1-1102606-5	79
0-1108629-1	43	0-1110960-1	175	1-1102240-7	73	1-1102331-1	141	1-1102496-1	90	1-1102610-5	99
0-1108713-1	79	0-1110960-2	175	1-1102243-7	73	1-1102331-2	146	1-1102496-3	96	1-1102611-5	99
0-1108723-1	178	0-1110960-3	175	1-1102244-2	74	1-1102331-8	149	1-1102496-6	87	1-1102612-5	99
0-1108741-3	--	0-1110984-4	59	1-1102244-8	77	1-1102333-1	141	1-1102496-7	92	1-1102613-5	126
0-1108761-1	111	0-1747363-1	197	1-1102246-2	74	1-1102333-2	146	1-1102499-1	90	1-1102617-5	126
0-1108762-1	111	0-1747364-1	197	1-1102249-2	74	1-1102333-8	149	1-1102499-3	96	1-1102618-5	125
0-1108780-1	138	0-1747365-1	197	1-1102249-8	78	1-1102336-1	141	1-1102499-6	87	1-1102622-5	150
0-1108780-1	171	0-1747366-1	197	1-1102251-2	74	1-1102336-2	147	1-1102502-6	87	1-1102623-5	150
0-1108780-1	202	1-1102002-7	167	1-1102251-8	78	1-1102339-1	141	1-1102502-7	92	1-1102624-5	151
0-1108780-1	203	1-1102005-7	167	1-1102253-2	75	1-1102339-2	147	1-1102505-1	90	1-1102625-5	151
0-1108780-2	138	1-1102008-7	167	1-1102255-2	75	1-1102340-2	145	1-1102505-6	87	1-1102626-5	151
0-1108780-2	171	1-1102009-2	167	1-1102258-2	76	1-1102340-6	143	1-1102505-7	92	1-1102631-5	79
0-1108780-2	202	1-1102011-2	167	1-1102261-1	90	1-1102343-2	146	1-1102507-1	88	1-1102635-5	79
0-1108780-2	203	1-1102013-2	167	1-1102261-3	96	1-1102343-6	143	1-1102507-2	93	1-1102638-5	79
0-1108780-6	171	1-1102015-2	167	1-1102261-6	87	1-1102345-2	146	1-1102509-1	88	1-1102640-5	98
0-1108780-6	203	1-1102017-2	167	1-1102261-7	92	1-1102345-6	143	1-1102509-2	93	1-1102642-5	98
0-1108780-7	171	1-1102027-7	167	1-1102264-6	87	1-1102348-1	162	1-1102511-1	88	1-1102644-5	98
0-1108780-7	203	1-1102030-7	167	1-1102267-1	90	1-1102348-3	165	1-1102511-2	93	1-1102646-5	98
0-1108782-1	114	1-1102033-7	167	1-1102267-6	87	1-1102348-6	160	1-1102511-8	97	1-1102647-5	98
0-1108782-1	159	1-1102101-7	49	1-1102267-7	92	1-1102348-7	163	1-1102513-1	88	1-1102649-5	125
0-1108782-1	202	1-1102103-7	49	1-1102270-6	87	1-1102351-6	160	1-1102513-2	93	1-1102651-5	125
0-1108782-1	203	1-1102105-2	49	1-1102271-1	88	1-1102351-7	163	1-1102513-8	97	1-1102653-5	125

Sortiert nach Tyco-PN/Sorted by Tyco PN

Best-Nr.	Seite	Best-Nr.	Seite	Best-Nr.	Seite	Best-Nr.	Seite	Best-Nr.	Seite	Best-Nr.	Seite
1-1102655-5	125	1-1103417-8	166	1-1106301-9	182	175194-2	33	2-1102301-8	124	2-1102564-6	115
1-1102656-5	125	1-1103417-9	166	1-1106302-9	183	175195-2	33	2-1102304-1	117	2-1102564-7	120
1-1102658-5	150	1-1103634-1	66	1-1106302-9	213	175196-2	33	2-1102305-2	121	2-1102567-1	118
1-1102660-5	150	1-1103635-1	66	1-1106303-9	183	175216-2	33	2-1102305-6	119	2-1102567-3	123
1-1102662-5	150	1-1103636-1	81	1-1106303-9	213	175217-2	33	2-1102308-2	122	2-1102567-6	115
1-1102664-5	150	1-1103637-1	81	1-1106304-9	183	175218-2	33	2-1102308-6	119	2-1102567-7	120
1-1102665-5	151	1-1103638-1	106	1-1106304-9	213	175284-2	33	2-1102310-2	122	2-1102570-1	118
1-1102765-0	115	1-1103638-1	155	1-1106305-9	181	175285-2	33	2-1102310-6	119	2-1102570-6	116
1-1102766-0	115	1-1103638-9	155	1-1106306-9	181	175286-2	33	2-1102316-3	148	2-1102570-7	120
1-1102770-6	190	1-1103639-1	106	1-1106307-9	181	175287-2	33	2-1102316-6	139	2-1102573-6	116
1-1102771-6	190	1-1103639-1	155	1-1106308-9	181	175288-2	33	2-1102316-7	144	2-1102575-1	116
1-1102772-6	188	1-1103639-9	155	1-1106309-9	181	175289-2	33	2-1102319-1	142	2-1102575-2	121
1-1102773-6	191	1-1103640-1	132	1-1106427-0	98	2-1102101-7	49	2-1102319-6	139	2-1102577-1	116
1-1102975-9	177	1-1103640-1	168	1-1106430-0	87	2-1102105-2	49	2-1102319-7	144	2-1102579-1	116
1-1102978-9	177	1-1103640-9	168	1-1106430-2	90	2-1102107-2	49	2-1102325-6	140	2-1102587-1	117
1-1103092-0	58	1-1103641-1	132	1-1106430-4	96	2-1102121-2	64	2-1102328-6	140	2-1102589-2	122
1-1103092-1	58	1-1103641-1	168	1-1106430-6	96	2-1102205-3	77	2-1102328-7	145	2-1102589-6	119
1-1103092-2	58	1-1103641-9	168	1-1106434-1	92	2-1102205-7	73	2-1102331-1	141	2-1102591-2	122
1-1103092-3	58	1-1104204-1	113	1-1106434-3	96	2-1102211-1	90	2-1102331-2	146	2-1102591-6	119
1-1103092-4	58	1-1104204-1	156	1-1106434-4	97	2-1102211-3	96	2-1102331-8	149	2-1102593-2	122
1-1103336-1	142	1-1104205-1	113	1-1106434-5	90	2-1102211-6	87	2-1102333-1	141	2-1102595-2	122
1-1103336-3	148	1-1104205-1	156	1-1106448-0	124	2-1102211-7	92	2-1102336-1	141	2-1102600-5	53
1-1103336-6	139	1-1104206-1	156	1-1106448-1	124	2-1102214-6	87	2-1102340-2	145	2-1102601-5	54
1-1103336-7	144	1-1104207-1	156	1-1106449-0	115	2-1102220-3	123	2-1102340-6	143	2-1102602-5	53
1-1103338-1	142	1-1105000-2	35	1-1106449-1	120	2-1102232-3	148	2-1102343-2	146	2-1102603-5	53
1-1103338-3	148	1-1105000-3	35	1-1106449-2	118	2-1102233-3	174	2-1102343-6	143	2-1102604-5	80
1-1103338-6	139	1-1105001-3	35	1-1106449-4	123	2-1102234-3	174	2-1102348-3	165	2-1102605-5	80
1-1103338-7	144	1-1105050-1	34	1-1106449-8	115	2-1102235-3	174	2-1102348-6	160	2-1102606-5	79
1-1103341-1	142	1-1105051-1	34	1-1106451-0	124	2-1102236-3	174	2-1102348-7	163	2-1102611-5	99
1-1103341-6	140	1-1105051-2	34	1-1106452-0	115	2-1102237-8	174	2-1102351-6	160	2-1102612-5	99
1-1103341-7	145	1-1105100-1	37	1-1106452-1	120	2-1102240-3	77	2-1102351-7	163	2-1102617-5	126
1-1103344-1	142	1-1105100-2	37	1-1106452-2	118	2-1102240-7	73	2-1102352-1	160	2-1102618-5	125
1-1103344-6	140	1-1105101-1	37	1-1106452-4	123	2-1102243-7	73	2-1102352-2	164	2-1102622-5	150
1-1103344-7	145	1-1105101-2	37	1-1106452-6	123	2-1102244-2	74	2-1102352-8	165	2-1102623-5	150
1-1103346-1	141	1-1105250-1	40	1-1106452-7	115	2-1102244-8	77	2-1102354-1	161	2-1102625-5	151
1-1103346-2	146	1-1105251-1	40	1-1106464-0	149	2-1102246-2	74	2-1102356-1	161	2-1102626-5	151
1-1103346-8	149	1-1105300-1	38	1-1106465-0	142	2-1102249-2	74	2-1102360-2	164	2-1102628-5	151
1-1103348-1	141	1-1105300-2	38	1-1106465-1	139	2-1102249-8	78	2-1102360-6	162	2-1102631-5	79
1-1103348-2	146	1-1105301-1	38	1-1106465-2	144	2-1102251-2	74	2-1102376-7	172	2-1102633-5	79
1-1103350-1	141	1-1105301-2	38	1-1106465-3	142	2-1102251-8	78	2-1102385-7	172	2-1102635-5	79
1-1103350-2	146	1-1105350-1	43	1-1106465-5	148	2-1102253-2	75	2-1102389-2	173	2-1102637-5	79
1-1103350-8	149	1-1105351-1	43	1-1106465-9	148	2-1102255-2	75	2-1102395-2	173	2-1102638-5	79
1-1103352-1	141	1-1105652-8	41	1-1106467-0	139	2-1102258-2	76	2-1102397-2	173	2-1102642-5	98
1-1103352-2	146	1-1105653-8	41	1-1106467-1	144	2-1102259-7	92	2-1102408-3	148	2-1102644-5	98
1-1103352-8	149	1-1105653-8	42	1-1106469-0	149	2-1102261-1	90	2-1102411-6	139	2-1102647-5	98
1-1103355-1	141	1-1105752-8	43	1-1106469-1	78	2-1102261-3	96	2-1102411-7	144	2-1102651-5	125
1-1103355-2	147	1-1105850-8	34	1-1106469-2	149	2-1102261-6	87	2-1102414-6	140	2-1102655-5	125
1-1103358-1	141	1-1105850-8	35	1-1106470-0	139	2-1102261-7	92	2-1102461-3	77	2-1102656-5	125
1-1103358-2	147	1-1105850-8	37	1-1106470-1	144	2-1102264-6	87	2-1102461-7	73	2-1102660-5	150
1-1103360-2	146	1-1105850-8	38	1-1106470-2	142	2-1102267-1	90	2-1102467-7	74	2-1102664-5	150
1-1103360-6	143	1-1105850-8	39	1-1106470-6	148	2-1102267-6	87	2-1102472-2	75	2-1102665-5	151
1-1103362-2	146	1-1105850-8	40	1-1106470-8	148	2-1102267-7	92	2-1102472-8	78	2-1102765-0	115
1-1103362-6	143	1-1105850-8	41	1-1106470-9	139	2-1102270-6	87	2-1102474-2	75	2-1102766-0	115
1-1103364-2	146	1-1105851-8	34	1-1106477-0	160	2-1102271-1	88	2-1102474-8	78	2-1102770-0	190
1-1103364-6	143	1-1105851-8	37	1-1106477-1	163	2-1102271-2	93	2-1102480-2	75	2-1102770-5	190
1-1103366-2	146	1-1105851-8	38	1-1106477-2	162	2-1102271-8	96	2-1102482-2	75	2-1102771-0	190
1-1103366-6	143	1-1105852-8	34	1-1106477-4	165	2-1102274-1	88	2-1102489-2	76	2-1102771-5	190
1-1103400-1	45	1-1105852-8	37	1-1106477-6	165	2-1102274-2	93	2-1102496-1	90	2-1102772-0	188
1-1103401-1	45	1-1105852-8	38	1-1107001-2	173	2-1102274-8	97	2-1102496-3	96	2-1102772-5	188
1-1103402-1	45	1-1105870-8	40	1-1107003-2	173	2-1102276-1	88	2-1102496-6	87	2-1102773-0	191
1-1103403-1	45	1-1106001-9	189	1-1107005-2	173	2-1102276-8	97	2-1102496-7	92	2-1102773-5	191
1-1103414-1	60	1-1106004-9	189	1-1107007-2	173	2-1102279-1	89	2-1102499-1	90	2-1103000-3	48
1-1103415-1	60	1-1106005-7	190	1-1108756-1	39	2-1102283-2	93	2-1102499-3	96	2-1103001-3	48
1-1103416-1	100	1-1106006-9	190	1-1108757-1	39	2-1102283-6	91	2-1102499-6	87	2-1103002-3	48
1-1103416-1	127	1-1106007-4	188	1-1108759-2	50	2-1102286-2	94	2-1102502-1	90	2-1103003-3	48
1-1103416-1	152	1-1106007-9	188	1-1110952-0	42	2-1102286-6	91	2-1102502-6	87	2-1103004-3	62
1-1103416-1	166	1-1106050-1	193	1-1110953-1	42	2-1102288-2	94	2-1102505-1	90	2-1103005-3	62
1-1103416-7	127	1-1106052-1	193	1-163087-1	35	2-1102291-1	140	2-1102505-6	87	2-1103006-3	69
1-1103416-7	152	1-1106053-1	193	1318105-1	33	2-1102291-2	145	2-1102505-7	92	2-1103007-3	69
1-1103416-7	166	1-1106053-2	193	1318106-1	33	2-1102291-8	149	2-1102507-1	88	2-1103008-3	84
1-1103416-8	152	1-1106055-2	191	1318107-1	33	2-1102292-3	123	2-1102509-1	88	2-1103009-3	84
1-1103416-8	166	1-1106056-3	191	1318108-1	33	2-1102292-6	115	2-1102511-1	88	2-1103010-3	102
1-1103416-9	166	1-1106057-4	191	1318109-1	33	2-1102292-7	120	2-1102511-8	97	2-1103010-3	129
1-1103417-1	100	1-1106058-5	192	1318110-1	33	2-1102295-6	115	2-1102513-8	97	2-1103011-3	102
1-1103417-1	127	1-1106062-7	192	1318111-1	33	2-1102295-7	120	2-1102519-2	94	2-1103011-3	129
1-1103417-1	152	1-1106066-8	192	1318112-1	33	2-1102296-1	116	2-1102521-2	94	2-1103012-3	110
1-1103417-1	166	1-1106100-1	180	1-66504-0	32	2-1102296-2	121	2-1102525-2	94	2-1103012-3	158
1-1103417-7	127	1-1106101-1	180	1-66505-0	32	2-1102296-8	123	2-1102527-2	94	2-1103013-3	110
1-1103417-7	152	1-1106102-1	180	1-66506-0	32	2-1102299-1	116	2-1102527-6	91	2-1103013-3	158
1-1103417-7	166	1-1106107-1	179	1-66507-0	32	2-1102299-8	124	2-1102564-1	118	2-1103032-3	136
1-1103417-8	152	1-1106109-1	179	169424-1	32	2-1102301-1	116	2-1102564-3	123	2-1103032-3	170

Sortiert nach Tyco-PN/Sorted by Tyco PN

Best-Nr.	Seite	Best-Nr.	Seite	Best-Nr.	Seite	Best-Nr.	Seite	Best-Nr.	Seite	Best-Nr.	Seite
2-1103033-3	136	2-1103637-3	81	3-1102770-2	190	4-1102759-5	150	5-1105653-8	42	7-1103417-1	152
2-1103033-3	170	2-1103638-3	106	3-1102771-2	190	4-1102760-5	151	5-1106001-9	189	7-1103417-1	166
2-1103100-3	47	2-1103638-3	155	3-1102772-2	188	4-1102770-0	190	5-1106004-9	189	7-1103417-7	127
2-1103101-3	47	2-1103638-9	155	3-1102773-2	191	4-1102771-0	190	5-1106005-7	190	7-1103417-7	152
2-1103102-3	47	2-1103639-3	106	3-1105000-2	35	4-1102772-0	188	5-1106006-9	190	7-1103417-7	166
2-1103103-3	47	2-1103639-3	155	3-1105050-2	34	4-1102773-0	191	5-1106050-1	193	7-1103417-8	152
2-1103104-3	47	2-1103639-9	155	3-1105051-1	34	4-1105000-3	35	5-1106051-1	193	7-1103417-8	166
2-1103105-3	47	2-1103640-3	132	3-1105051-2	34	4-1105001-3	35	5-1106053-1	193	7-1103634-1	66
2-1103106-3	61	2-1103640-3	168	3-1105100-1	37	4-1105050-2	34	5-1106053-2	193	7-1103635-1	66
2-1103107-3	61	2-1103640-9	168	3-1105100-2	37	4-1105051-1	34	5-1106055-2	191	7-1103636-1	81
2-1103108-3	101	2-1103641-3	132	3-1105101-1	37	4-1105051-2	34	5-1106056-3	191	7-1103637-1	81
2-1103108-3	128	2-1103641-3	168	3-1105101-2	37	4-1105100-1	37	5-1106057-4	191	7-1103638-1	106
2-1103109-3	101	2-1103641-9	168	3-1105150-1	41	4-1105100-2	37	5-1106058-5	192	7-1103638-1	155
2-1103109-3	128	2-1104000-3	68	3-1105150-2	41	4-1105101-1	37	5-1106062-6	192	7-1103638-9	155
2-1103110-3	109	2-1104002-3	68	3-1105151-1	41	4-1105101-2	37	5-1106207-7	184	7-1103639-1	106
2-1103110-3	157	2-1104004-3	83	3-1105151-2	41	4-1105150-1	41	5-1106213-6	184	7-1103639-1	155
2-1103111-3	109	2-1104006-3	83	3-1105250-1	40	4-1105150-2	41	5-1106302-9	183	7-1103639-9	155
2-1103111-3	157	2-1104008-3	108	3-1105251-1	40	4-1105151-1	41	5-1106302-9	213	7-1103640-1	132
2-1103112-3	135	2-1104010-3	108	3-1105300-1	38	4-1105151-2	41	5-1108751-1	39	7-1103640-1	168
2-1103112-3	169	2-1104012-3	134	3-1105300-2	38	4-1105250-1	40	5-1108757-1	39	7-1103640-9	168
2-1103113-3	135	2-1104014-3	134	3-1105301-1	38	4-1105251-1	40	523168-5	34	7-1103641-1	132
2-1103113-3	169	2-1104016-3	134	3-1105301-2	38	4-1105300-1	38	523168-5	38	7-1103641-1	168
2-1103200-3	70	2-1104018-3	134	3-1105653-8	41	4-1105300-2	38	523168-6	37	7-1103641-9	168
2-1103202-3	70	2-1104200-3	137	3-1105653-8	42	4-1105301-1	38	523168-7	39	7-1105653-8	42
2-1103204-3	85	2-1104202-3	137	3-1106001-9	189	4-1105301-2	38	530341-1	212	7-1106001-9	189
2-1103206-3	85	2-1105000-3	35	3-1106004-9	189	4-1105653-8	41	5-569550-4	199	7-1106004-9	189
2-1103208-3	109	2-1105001-3	35	3-1106005-7	190	4-1105653-8	42	601967-1	34	7-1106053-7	190
2-1103208-3	157	2-1105050-2	34	3-1106006-9	190	4-1106001-9	189	601967-1	37	7-1106006-9	190
2-1103209-3	157	2-1105051-1	34	3-1106050-1	193	4-1106004-9	189	601967-1	38	7-1106050-1	193
2-1103212-3	109	2-1105051-2	34	3-1106051-1	193	4-1106005-7	190	601967-1	39	7-1106052-1	193
2-1103212-3	157	2-1105100-1	37	3-1106053-1	193	4-1106006-9	190	6-1105100-1	37	7-1106053-1	193
2-1103213-3	157	2-1105100-2	37	3-1106055-2	191	4-1106050-1	193	6-1105101-1	37	7-1106053-2	193
2-1103216-3	135	2-1105101-1	37	3-1106056-3	191	4-1106051-1	193	6-1105250-1	40	7-1106055-2	191
2-1103216-3	169	2-1105101-2	37	3-1106057-4	191	4-1106052-1	193	6-1105251-1	40	7-1106056-3	191
2-1103217-3	169	2-1105250-1	40	3-1106058-5	192	4-1106052-1	193	6-1105300-1	38	7-1106057-4	191
2-1103220-3	135	2-1105251-1	40	3-1106062-6	192	4-1106055-2	191	6-1105300-2	38	7-1106058-5	192
2-1103220-3	169	2-1105300-1	38	3-1106066-8	192	4-1106056-3	191	6-1105301-1	38	7-1106302-9	183
2-1103221-3	169	2-1105300-2	38	3-1106200-5	54	4-1106057-4	191	6-1105301-2	38	7-1106302-9	213
2-1103336-6	139	2-1105301-1	38	3-1106201-5	80	4-1106058-5	192	6-1105653-8	42	726363-1	32
2-1103338-1	142	2-1105301-2	38	3-1106201-5	185	4-1106062-6	192	6-1106001-9	189	734285-1	36
2-1103338-3	148	2-1105350-1	43	3-1106202-5	99	4-1106066-8	192	6-1106004-9	189	734285-2	36
2-1103338-6	139	2-1105351-1	43	3-1106202-5	185	4-1106200-5	54	6-1106005-7	190	734285-3	36
2-1103338-7	144	2-1105652-8	41	3-1106203-5	126	4-1106201-5	80	6-1106006-9	190	8-1105653-8	42
2-1103341-6	140	2-1105653-8	41	3-1106203-5	185	4-1106201-5	185	6-1106050-1	193	8-1106058-5	192
2-1103344-1	142	2-1105653-8	42	3-1106204-5	151	4-1106202-5	99	6-1106052-1	193	8-1106062-6	192
2-1103344-6	140	2-1105870-8	40	3-1106204-5	185	4-1106202-5	185	6-1106053-1	193	8-1108772-0	95
2-1103344-7	145	2-1106001-9	189	3-1106214-0	184	4-1106203-5	126	6-1106055-2	191	8-1108772-2	95
2-1103346-1	141	2-1106004-9	189	3-1106216-0	184	4-1106203-5	185	6-1106056-3	191	8-1108772-4	95
2-1103348-1	141	2-1106005-7	190	3-1106302-9	183	4-1106204-5	151	6-1106057-4	191	8-1108772-5	95
2-1103350-1	141	2-1106006-9	190	3-1106302-9	213	4-1106204-5	185	6-1106062-6	192	8-1108772-8	95
2-1103350-2	146	2-1106007-3	188	3-1106303-9	183	4-1106202-9	183	6-1106066-8	192	872070-1	36
2-1103350-8	149	2-1106050-1	193	3-1106303-9	213	4-1106302-9	213	6-1106302-9	183	9-1106062-6	192
2-1103352-1	141	2-1106053-1	193	3-1106470-0	140	4-1108756-1	39	6-1106302-9	213	91285-1	32
2-1103352-8	149	2-1106053-2	193	3-1106470-5	144	4-1108757-1	39	66504-3	32	91558-1	33
2-1103364-2	146	2-1106055-2	191	3-1108756-1	39	5-1102610-5	99	66504-4	32	91559-1	33
2-1103364-6	143	2-1106056-3	191	3-1108757-1	39	5-1102616-5	126	66504-9	32	91560-1	33
2-1103414-3	60	2-1106057-4	191	4-1102700-5	53	5-1102624-5	151	66505-3	32	91565-1	33
2-1103415-3	60	2-1106058-5	192	4-1102701-5	54	5-1102708-5	80	66505-4	32	91576-1	33
2-1103416-3	100	2-1106062-6	192	4-1102702-5	53	5-1102709-5	80	66505-9	32	91595-1	33
2-1103416-3	127	2-1106066-8	192	4-1102703-5	53	5-1102716-5	99	66506-3	32	91596-1	33
2-1103416-3	152	2-1106206-7	184	4-1102704-5	79	5-1102770-0	190	66506-4	32	917484-2	33
2-1103416-3	166	2-1106208-7	184	4-1102706-5	79	5-1102771-0	190	66506-9	32	917485-2	33
2-1103416-7	127	2-1106214-0	184	4-1102710-5	79	5-1102772-0	188	66507-3	32	917511-2	33
2-1103416-7	152	2-1106214-1	184	4-1102712-5	79	5-1102773-0	191	66507-4	32	929962-1	36
2-1103416-7	166	2-1106216-0	184	4-1102714-5	98	5-1105050-2	34	66507-9	32	929963-1	36
2-1103416-8	152	2-1106216-1	184	4-1102715-5	98	5-1105051-1	34	69675-1	43	929964-1	36
2-1103416-8	166	2-1106302-9	183	4-1102717-5	99	5-1105051-2	34	69710-1	43	929965-1	36
2-1103416-9	166	2-1106302-9	213	4-1102718-5	98	5-1105100-1	37	7-1103414-1	60	929969-1	36
2-1103417-3	100	2-1106303-9	183	4-1102720-5	99	5-1105100-2	37	7-1103415-1	60	929970-1	36
2-1103417-3	127	2-1106303-9	213	4-1102723-5	125	5-1105101-1	37	7-1103416-1	100	929971-1	36
2-1103417-3	152	2-1106310-9	213	4-1102725-5	125	5-1105101-2	37	7-1103416-1	127	929972-1	36
2-1103417-3	166	2-1106311-9	213	4-1102726-5	126	5-1105150-1	41	7-1103416-1	152	962966-1	36
2-1103417-7	127	2-1106312-9	213	4-1102727-5	126	5-1105150-2	41	7-1103416-1	166	962967-1	36
2-1103417-7	152	2-1106313-9	213	4-1102728-5	125	5-1105151-1	41	7-1103416-7	127	962968-1	36
2-1103417-7	166	2-1106449-1	123	4-1102730-5	125	5-1105151-2	41	7-1103416-7	152	962969-1	36
2-1103417-8	152	2-1106449-2	123	4-1102732-5	150	5-1105250-1	40	7-1103416-7	166	962976-1	36
2-1103417-8	166	2-1106449-4	123	4-1102733-5	150	5-1105251-1	40	7-1103416-8	152	962977-1	36
2-1103417-9	166	2-1107005-2	173	4-1102734-5	151	5-1105300-1	38	7-1103416-8	166	962978-1	36
2-1103634-3	66	2-1107007-2	173	4-1102735-5	151	5-1105300-2	38	7-1103416-9	166	962979-1	36
2-1103635-3	66	2-1108756-1	39	4-1102736-5	151	5-1105301-1	38	7-1103417-1	100		
2-1103636-3	81	2-1108757-1	39	4-1102755-5	150	5-1105301-2	38	7-1103417-1	127		

Sortiert nach Bezeichnung/Sorted by description

Bestelltext	Best-Nr.	Seite	Bestelltext	Best-Nr.	Seite	Bestelltext	Best-Nr.	Seite
120 mm ² , Kz 200-1110956-5	42		Die 25 mm ² , Kz 10	5-1105653-8	42	EMV-K.3/4.SG.1.M16.G	0-1106401-2	54
150 mm ² , Kz 220-1110956-6	42		Die 35 mm ² , Kz 12	6-1105653-8	42	EMV-K.3/4.SG.1.M20.G	0-1106401-3	54
50 mm ² , Kz 140-1110956-2	42		Die 50 mm ² , Kz 14	7-1105653-8	42	EMV-K.3/4.SGF	4-1102702-5	53
70 mm ² , Kz 160-1110956-3	42		Die 6 mm ² , Kz 5	2-1105653-8	41	EMV-K.3/4.STO.1.11.G	4-1102700-5	53
95 mm ² , Kz 180-1110956-4	42		Die 6 mm ² , Kz 5	2-1105653-8	42	EMV-K.3/4.STO.1.M16.G	0-1106402-2	53
AIR.Bu.4.VA0-1105355-2 200			Die 70 mm ² , Kz 16	8-1105653-8	42	EMV-K.3/4.STO.1.M20.G	0-1106402-3	53
AIR.Bu.V.4.VA0-1105355-1 200			DIE COAXICON	69675-1	43	EMV-K.6/16.AG	4-1102710-5	79
AIR.Sti.4.VA0-1105354-1 200			DIE F2,8FF TAB	0-0539744-2	35	EMV-K.6/16.AG.M6	4-1102712-5	79
AM.1x15.BG.2-00-1107197-2	186		DS.11.DI	1-1106004-9	189	EMV-K.6/16.SG.1.16.G	5-1102708-5	80
AM.1x15.BG.2-U	0-1107196-2	186	DS.13.DI	2-1106004-9	189	EMV-K.6/16.SG.1.M25.G	0-1106415-3	80
AM.1x15+25.BG.4-0	0-1107201-2	187	DS.16.DI	3-1106004-9	189	EMV-K.6/16.SG.2.16.G	5-1102709-5	80
AM.1x15+25.BG.4-U	0-1107200-2	187	DS.21.DI	4-1106004-9	189	EMV-K.6/16.SG.2.M32.G	0-1106415-2	80
AM.1x25.BG.2-0	0-1107197-3	186	DS.29.DI	5-1106004-9	189	EMV-K.6/16.STO.1.16.G	4-1102706-5	79
AM.1x25.BG.2-U	0-1107196-3	186	DS.36.DI	6-1106004-9	189	EMV-K.6/16.STO.1.M32.G	0-1106416-3	79
AM.1x25+37.BG.6-0	0-1107205-2	187	DS.42.DI	7-1106004-9	189	EMV-K.6/16.STS.1.16.G	4-1102704-5	79
AM.1x25+37.BG.6-U	0-1107204-2	187	Dynamic 0,06-0,2 mm ² Loose Piece	175216-2	33	EMV-K.6/16.STS.1.M25.G	0-1106416-4	79
AM.1x37.BG.5-0	0-1107203-1	186	Dynamic 0,06-0,2 mm ² Loose Piece	175287-2	33	EMV-KF/K.24/64.STS.1.29.G	4-1102732-5	150
AM.1x37.BG.5-U	0-1107202-1	186	Dynamic 0,06-0,2 mm ² Strip Form	175194-2	33	EMV-KF/K.24/64.STS.1.36.G	4-1102733-5	150
AM.1x50.BG.5-0	0-1107203-2	186	Dynamic 0,06-0,2 mm ² Strip Form	175284-2	33	EMV-KF/K.24/64.STS.1.M40.G	0-1106462-2	150
AM.1x50.BG.5-U	0-1107202-2	186	Dynamic 0,08-0,2 mm ² Loose Piece	1318108-1	33	EMV-Konenpaar PG16/M28	1-1106007-4	188
AM.1x9.BG.2-0	0-1107197-1	186	Dynamic 0,08-0,2 mm ² Loose Piece	1318112-1	33	EMV-Konenpaar PG21/Pg21	1-1106007-9	188
AM.1x9.BG.2-U	0-1107196-1	186	Dynamic 0,08-0,2 mm ² Strip Form	1318106-1	33	EMV-Konenpaar PG29	2-1106007-3	188
AM.1x9+1x15+1x25.BG.6-0	0-1107205-1	187	Dynamic 0,08-0,2 mm ² Strip Form	1318110-1	33	ERW.11/13.MS	1-1106058-5	192
AM.1x9+1x15+1x25.BG.6-U	0-1107204-1	187	Dynamic 0,2-0,5 mm ² Loose Piece	175217-2	33	ERW.11/16.MS	7-1106058-5	192
AM.2x15.BG.3-0	0-1107199-2	187	Dynamic 0,2-0,5 mm ² Loose Piece	175288-2	33	ERW.13/16.MS	2-1106058-5	192
AM.2x15.BG.3-U	0-1107198-2	187	Dynamic 0,2-0,5 mm ² Strip Form	175195-2	33	ERW.13/21.MS	8-1106058-5	192
AM.2x25.BG.4-0	0-1107201-1	187	Dynamic 0,2-0,5 mm ² Strip Form	175285-2	33	ERW.16/21.MS	3-1106058-5	192
AM.2x25.BG.4-U	0-1107200-1	187	Dynamic 0,3-0,85 mm ² Loose Piece	1318107-1	33	ERW.21/29.MS	4-1106058-5	192
AM.2x37.BG.6-0	0-1107205-3	187	Dynamic 0,3-0,85 mm ² Loose Piece	1318111-1	33	ERW.29/36.MS	5-1106058-5	192
AM.2x37.BG.6-U	0-1107204-3	187	Dynamic 0,3-0,85 mm ² Strip Form	1318105-1	33	EWZG-RSZ	0-1102855-6	34
AM.2x50.BG.6-U	0-1107204-4	187	Dynamic 0,3-0,85 mm ² Strip Form	1318109-1	33	EWZG-RSZ	0-1102855-6	35
AM.2x9.BG.3-0	0-1107199-1	187	Dynamic 0,5-1,25 mm ² Loose Piece	175218-2	33	EWZG-RSZ	0-1102855-6	37
AM.2x9.BG.3-U	0-1107198-1	187	Dynamic 0,5-1,25 mm ² Loose Piece	175289-2	33	EWZG-RSZ	0-1102855-6	38
AP.M.1.11	1-1102978-9	177	Dynamic 0,5-1,25 mm ² Strip Form	175196-2	33	EWZG-RSZ	0-1102855-6	39
AP.M.1.M20	0-1102978-2	177	Dynamic 0,5-1,25 mm ² Strip Form	175286-2	33	EWZG-RSZ	0-1102855-6	40
ASD.11.N	1-1106050-1	193	Dynamic 1,25-2,2 mm ² Loose Piece	917511-2	33	EWZG-RSZ	0-1102855-6	44
ASD.13.N	2-1106050-1	193	Dynamic 1,25-2,2 mm ² Strip Form	917484-2	33	Extraction Tool 2,5 mm Contact	872070-1	36
ASD.16.N	3-1106050-1	193	Dynamic 1,25-2,2 mm ² Strip Form	917485-2	33	F-Bu.M3	1-1106101-1	180
ASD.21.N	4-1106050-1	193	DYNAMIC D-2800 REC HSG 30P	0-1747365-1	197	FOAC MELTING GAGE OPTIMATE	0-0100606-2	44
ASD.29.N	5-1106050-1	193	DYNAMIC D-2800 TAB HSG 30P	0-1747366-1	197	FOPOF CUTTING GAGE , MULTIMATE	0-0100281-1	44
ASD.36.N	6-1106050-1	193	DYNAMIC D-3800 REC HSG 12P	0-1747363-1	197	FOPOF LONG CONTACT ASSY	0-0216341-1	44
ASD.42.N	7-1106050-1	193	DYNAMIC D-3800 TAB HSG 12P	0-1747364-1	197	FOPOF MELTING ADAPTOR, MULTIMATE	0-0100281-2	44
ASD-K.11.V	1-1106052-1	193	EMV.3/4.SG.1.M20.G	0-1106401-4	54	FOPOF SHORT CONTACT ASSY	0-0216342-1	44
ASD-K.16.N	3-1106051-1	193	EMV.M16.MS	1-1102772-6	188	FOTOOL HOTMELT UNIT	0-0734423-1	44
ASD-K.21.N	4-1106051-1	193	EMV.M20.MS	2-1102772-0	188	Frame AF8	601967-1	37
ASD-K.21.V	4-1106052-1	193	EMV.M25.MS	2-1102772-5	188	Frame AF8	601967-1	38
ASD-K.29.N	5-1106051-1	193	EMV.M32.MS	3-1102772-2	188	Frame AF8	601967-1	39
ASD-K.36.V	6-1106052-1	193	EMV.M40.MS	4-1102772-0	188	F-Sti-M3	1-1106102-1	180
ASD-K.42.V	7-1106052-1	193	EMV.M50.MS	5-1102772-0	188	GB.1-BG8	1-1106301-9	182
AWZG-HD.M-RSZ	0-1102855-1	35	EMV-K.10/24.AG	4-1102718-5	98	GM.11.SKT-MS	1-1106055-2	191
AWZG-HD.M-RSZ	0-1102855-1	44	EMV-K.10/24.AG.M6	4-1102720-5	99	GM.13.SKT-MS	2-1106055-2	191
AWZG-HE-Q5-RSZ	0-1102855-7	37	EMV-K.10/24.SG.1.21.G	5-1102716-5	99	GM.16.SKT-MS	3-1106055-2	191
AWZG-HN.D-RSZ	0-1102855-2	34	EMV-K.10/24.SG.2.21.G	4-1102717-5	99	GM.21.SKT-MS	4-1106055-2	191
AWZG-HSK-RSZ	0-1102855-8	39	EMV-K.10/24.SG.2.M32.G	0-1106426-2	99	GM.29.SKT-MS	5-1106055-2	191
AWZG-HSM-RSZ	0-1102855-4	40	EMV-K.10/24.STO.1.21.G	4-1102715-5	98	GM.36.SKT-MS	6-1106055-2	191
AWZG-HSS-RSZ	0-1102855-5	41	EMV-K.10/24.STO.1.M25.G	0-1106427-4	98	GM.42.SKT-MS	7-1106055-2	191
AWZG-HVT-RSZ	0-1102855-3	38	EMV-K.10/24.STS.1.21.G	4-1102714-5	98	HA.10.AGD-LB	1-1102122-2	64
AWZG-MDL-AIR	0-1102985-1	200	EMV-K.10/24.STS.1.M25.G	0-1106427-3	98	HA.10.AG-LB	1-1102121-2	64
BEO.M3.KURZ	1-1106109-1	179	EMV-K.10/24.STS.1.M32.G	1-1106427-0	98	HA.10.Bu.C.B1-10	2-1103415-3	60
BS.11.MS	1-1106056-3	191	EMV-K.16/40.AG	4-1102728-5	125	HA.10.Bu.S.B1-10	1-1103415-1	60
BS.13.MS	2-1106056-3	191	EMV-K.16/40.AG.M6	4-1102730-5	125	HA.10.Bu.SC.B1-10	7-1103415-1	60
BS.16.MS	3-1106056-3	191	EMV-K.16/40.SG.1.21.G	4-1102726-5	126	HA.10.KDO-LB.1.16.G	1-1102133-2	65
BS.21.MS	4-1106056-3	191	EMV-K.16/40.SG.2.21.G	4-1102727-5	126	HA.10.KDO-LB.1.M20.G	0-1106409-1	65
BS.29.MS	5-1106056-3	191	EMV-K.16/40.SG.2.M32.G	0-1106445-2	126	HA.10.SGD-LB.1.16.Z	1-1102128-2	65
BS.36.MS	6-1106056-3	191	EMV-K.16/40.STO.1.29.G	4-1102725-5	125	HA.10.SGD-LB.2.16.Z	1-1102130-2	65
BS.42.MS	7-1106056-3	191	EMV-K.16/40.STO.1.M32.G	0-1106446-3	125	HA.10.SGD-LB.2.M20.Z	0-1106410-1	65
BS.M16.MS	1-1102773-6	191	EMV-K.16/40.STS.1.29.G	4-1102723-5	125	HA.10.SG-LB.1.16.Z	1-1102124-2	64
BS.M20.MS	2-1102773-0	191	EMV-K.16/40.STS.1.M32.G	0-1106446-4	125	HA.10.SG-LB.2.16.Z	1-1102126-2	64
BS.M25.MS	2-1102773-5	191	EMV-K.24/64.AG	4-1102760-5	151	HA.10.SG-LB.2.M20.Z	0-1106410-2	64
BS.M32.MS	3-1102773-2	191	EMV-K.24/64.AG.M6	4-1102736-5	151	HA.10.SKB	2-1106206-7	184
BS.M40.MS	4-1102773-0	191	EMV-K.24/64.SG.1.29.G	4-1102734-5	151	HA.10.Sti.C.B1-10	2-1103414-3	60
BS.M50.MS	5-1102773-0	191	EMV-K.24/64.SG.2.29.G	4-1102735-5	151	HA.10.Sti.S.B1-10	1-1103414-1	60
CABLE STRIPPER	0-0501198-1	44	EMV-K.24/64.SG.2.M40.G	0-1106460-2	151	HA.10.Sti.SC.B1-10	7-1103414-1	60
Codier set HVS	530341-1	212	EMV-K.24/64.STO.1.29.G	4-1102759-5	150	HA.10.STO.1.16.G	1-1102120-7	63
COS.QUICK-IN	0-1110939-3	178	EMV-K.24/64.STO.1.M40.G	0-1106461-4	150	HA.10.STO.1.M20.G	0-1106411-1	63
CRIMPING TOOL M22520/1-01	601967-1	34	EMV-K.24/64.STS.1.29.G	4-1102755-5	150	HA.10.STS.1.16.G	1-1102117-7	63
CZ-HF.60.M	0-1110956-1	42	EMV-K.24/64.STS.1.M25.G	0-1102983-1	150	HA.10.STS.1.M20.G	0-1106411-2	63
DAHT-FIBER OPTIC	0-0090364-2	44	EMV-K.24/64.STS.1.M32.G	0-1106461-8	150	HA.10.STS.1.M25.G	0-1106411-6	63
Die 10 mm ² , Kz 5	3-1105653-8	41	EMV-K.24/64.STS.1.M40.G	0-1106461-3	150	HA.16.AGD-LB	1-1102141-2	104
Die 10 mm ² , Kz 5	3-1105653-8	42	EMV-K.3/4.AG	4-1102703-5	53	HA.16.AG-LB	1-1102140-2	104
Die 16 mm ² , Kz 8	4-1105653-8	41	EMV-K.3/4.SG.1.11.G	4-1102701-5	54	HA.16.Bu.C.B1-16	2-1103417-3	100
Die 16 mm ² , Kz 8	4-1105653-8	42						

Sortiert nach Bezeichnung/Sorted by description

Bestelltext	Best-Nr.	Seite	Bestelltext	Best-Nr.	Seite	Bestelltext	Best-Nr.	Seite
HA.16.Bu.C.B1-16	2-1103417-3	127	HA.3.SG-LB.1.11.Z	1-1102109-2	50	HB.10.SG-VS.2.16.Z	1-1102276-1	88
HA.16.Bu.C.B1-16	2-1103417-3	152	HA.3.SG-LB.1.M16.G	0-1106404-1	50	HB.10.SG-VS.2.M25.Z	0-1106429-4	88
HA.16.Bu.C.B1-16	2-1103417-3	166	HA.3.SG-LB.1.M20.G	0-1106404-3	50	HB.10.SKP	5-1106213-6	184
HA.16.Bu.C.B17-32	2-1103417-7	127	HA.3.Sti.S	1-1103400-1	45	HB.10.STO.1.16.G	1-1102267-6	87
HA.16.Bu.C.B17-32	2-1103417-7	152	HA.3.STW.1.11.Z	1-1102101-7	49	HB.10.STO.1.21.G	1-1102270-6	87
HA.16.Bu.C.B17-32	2-1103417-7	166	HA.3.STO.1.M16.Z	0-1106405-1	49	HB.10.STO.1.M25.G	0-1106430-1	87
HA.16.Bu.C.B33-48	2-1103417-8	152	HA.3.STO.1.M20.Z	0-1106405-3	49	HB.10.STO-GR.1.16.G	1-1102267-7	92
HA.16.Bu.C.B33-48	2-1103417-8	166	HA.3.STW.1.11.Z	1-1102103-7	49	HB.10.STO-GR.1.M25.G	0-1106430-2	92
HA.16.Bu.C.B49-64	2-1103417-9	166	HA.3.STW.1.M16.Z	0-1106406-1	49	HB.10.STO-VS.1.16.G	1-1102267-1	90
HA.16.Bu.S.B1-16	1-1103417-1	100	HA.3.STW.1.M20.Z	0-1106406-3	49	HB.10.STO-VS.1.M25.G	0-1106430-3	90
HA.16.Bu.S.B1-16	1-1103417-1	127	HA.32.AGD	1-1102165-1	131	HB.10.STS.1.16.G	1-1102261-6	87
HA.16.Bu.S.B1-16	1-1103417-1	152	HA.32.AG-VS	1-1102160-1	130	HB.10.STS.1.21.G	1-1102264-6	87
HA.16.Bu.S.B1-16	1-1103417-1	166	HA.32.SGD.1.21.Z	1-1102167-1	131	HB.10.STS.1.M25.G	0-1106430-4	87
HA.16.Bu.S.B17-32	1-1103417-7	127	HA.32.SGD.2.21.Z	1-1102169-1	131	HB.10.STS-GR.1.16.G	1-1102261-7	92
HA.16.Bu.S.B17-32	1-1103417-7	152	HA.32.SGD.2.M25.Z	0-1106455-1	131	HB.10.STS-GR.1.M25.G	0-1106430-5	92
HA.16.Bu.S.B17-32	1-1103417-7	166	HA.32.SG-VS.1.21.Z	1-1102162-1	130	HB.10.STS-VS.1.16.G	1-1102261-1	90
HA.16.Bu.S.B33-48	1-1103417-8	152	HA.32.SG-VS.2.21.Z	1-1102164-1	130	HB.10.STS-VS.1.M25.G	0-1106430-6	90
HA.16.Bu.S.B33-48	1-1103417-8	166	HA.32.SG-VS.2.M25.Z	0-1106455-2	130	HB.10.STW.1.16	0-1108713-1	79
HA.16.Bu.S.B49-64	1-1103417-9	166	HA.32.STO.1.21.G	1-1102158-6	130	HB.16.AGD	1-1102305-6	119
HA.16.Bu.SC.B1-16	7-1103417-1	100	HA.32.STO.1.M32.G	0-1106456-1	130	HB.16.AGD-LB	1-1102305-2	121
HA.16.Bu.SC.B1-16	7-1103417-1	127	HA.32.STO-VS.1.21.G	1-1102158-1	131	HB.16.AG-LB	1-1102296-2	121
HA.16.Bu.SC.B1-16	7-1103417-1	152	HA.32.STO-VS.1.M32.G	0-1106456-2	131	HB.16.AG-VS	1-1102296-1	116
HA.16.Bu.SC.B1-16	7-1103417-1	166	HA.32.STS.1.21.G	1-1102155-6	130	HB.16.KDO-LB.1.21.G	1-1102304-2	122
HA.16.Bu.SC.B17-32	7-1103417-7	127	HA.32.STS.1.M25.G	0-1106456-3	130	HB.16.KDO-LB.1.M32.G	0-1106447-1	122
HA.16.Bu.SC.B17-32	7-1103417-7	152	HA.32.STS-VS.1.21.G	1-1102155-1	131	HB.16.KDO-VS.1.21.G	1-1102304-1	117
HA.16.Bu.SC.B17-32	7-1103417-7	166	HA.32.STS-VS.1.M25.G	0-1106456-4	131	HB.16.KDO-VS.1.M32.G	0-1106447-2	117
HA.16.Bu.SC.B33-48	7-1103417-8	152	HA.4.Bu.S	1-1103403-1	45	HB.16.SGD.1.21.Z	1-1102308-6	119
HA.16.Bu.SC.B33-48	7-1103417-8	166	HA.4.Sti.S	1-1103402-1	45	HB.16.SGD.2.21.Z	1-1102310-6	119
HA.16.KDO-LB.1.16.G	1-1102152-2	105	HA.48.AGD-LB	1-1102177-2	153	HB.16.SGD.2.M25.Z	0-1106448-1	119
HA.16.KDO-LB.1.M20.G	0-1106437-1	105	HA.48.AG-LB	1-1102176-2	153	HB.16.SGD-LB.1.21.Z	1-1102308-2	122
HA.16.SGD-LB.1.16.Z	1-1102147-2	105	HA.48.SGD-LB.1.29.Z	1-1102183-2	154	HB.16.SGD-LB.2.21.Z	1-1102310-2	122
HA.16.SGD-LB.2.16.Z	1-1102149-2	105	HA.48.SGD-LB.1.M32.Z	0-1102879-1	154	HB.16.SGD-LB.2.M25.Z	0-1106448-2	122
HA.16.SGD-LB.2.M20.Z	0-1106438-1	105	HA.48.SGD-LB.2.29.Z	1-1102185-2	154	HB.16.SG-LB.1.21.Z	1-1102299-2	121
HA.16.SG-LB.1.16.Z	1-1102143-2	104	HA.48.SGD-LB.2.M32.Z	0-1102879-2	154	HB.16.SG-LB.2.21.Z	1-1102301-2	121
HA.16.SG-LB.2.16.Z	1-1102145-2	104	HA.48.SG-LB.1.29.Z	1-1102179-2	154	HB.16.SG-LB.2.M25.Z	0-1106448-3	121
HA.16.SG-LB.2.M20.Z	0-1106438-2	104	HA.48.SG-LB.2.29.Z	1-1102181-2	154	HB.16.SG-VS.1.21.Z	1-1102299-1	116
HA.16.SKB	2-1106208-7	184	HA.48.STO-GR.1.29.G	1-1102175-7	153	HB.16.SG-VS.2.21.Z	1-1102301-1	116
HA.16.Sti.C.B1-16	2-1103416-3	100	HA.48.STO-GR.1.M32.G	0-1102877-2	153	HB.16.SG-VS.2.M25.Z	0-1106448-4	116
HA.16.Sti.C.B1-16	2-1103416-3	127	HA.48.STS-GR.1.29.G	1-1102172-7	153	HB.16.SKP-LB	3-1106214-0	184
HA.16.Sti.C.B1-16	2-1103416-3	152	HA.48.STS-GR.1.M32.G	0-1102877-1	153	HB.16.SKP-VS	2-1106214-0	184
HA.16.Sti.C.B1-16	2-1103416-3	166	HA.64.AGD-LB	1-1102009-2	167	HB.16.SKP-VS+D	2-1106214-1	184
HA.16.Sti.C.B17-32	2-1103416-7	127	HA.64.SGD-LB.1.29.Z	1-1102011-2	167	HB.16.STO.1.21.G	1-1102295-6	115
HA.16.Sti.C.B17-32	2-1103416-7	152	HA.64.SGD-LB.1.36.Z	1-1102015-2	167	HB.16.STO.1.M32.G	0-1106449-1	115
HA.16.Sti.C.B17-32	2-1103416-7	166	HA.64.SGD-LB.2.29.Z	1-1102013-2	167	HB.16.STO-GR.1.21.G	1-1102295-7	120
HA.16.Sti.C.B33-48	2-1103416-8	152	HA.64.SGD-LB.2.36.Z	1-1102017-2	167	HB.16.STO-GR.1.M32.G	0-1106449-2	120
HA.16.Sti.C.B33-48	2-1103416-8	166	HA.64.STO-GR.1.29.G	1-1102027-7	167	HB.16.STO-GR.1.21.G	1-1102295-1	118
HA.16.Sti.C.B49-64	2-1103416-9	166	HA.64.STO-GR.1.36.G	1-1102030-7	167	HB.16.STO-VS.1.M32.G	0-1106449-3	118
HA.16.Sti.S.B1-16	1-1103416-1	100	HA.64.STO-GR.1.42.G	1-1102033-7	167	HB.16.STS.1.21.G	1-1102292-6	115
HA.16.Sti.S.B1-16	1-1103416-1	127	HA.64.STO-GR.1.M50.G	0-1106480-1	167	HB.16.STS.1.M32.G	0-1106449-4	115
HA.16.Sti.S.B1-16	1-1103416-1	152	HA.64.STS-GR.1.29.G	1-1102002-7	167	HB.16.STS-GR.1.21.G	1-1102292-7	120
HA.16.Sti.S.B1-16	1-1103416-1	166	HA.64.STS-GR.1.36.G	1-1102005-7	167	HB.16.STS-GR.1.M32.G	0-1106449-5	120
HA.16.Sti.S.B17-32	1-1103416-7	127	HA.64.STS-GR.1.42.G	1-1102008-7	167	HB.16.STS-VS.1.21.G	1-1102292-1	118
HA.16.Sti.S.B17-32	1-1103416-7	152	HA.64.STS-GR.1.M50.G	0-1106480-2	167	HB.16.STS-VS.1.M32.G	0-1106449-6	118
HA.16.Sti.S.B17-32	1-1103416-7	166	HA-K.10.AG-LB	2-1102121-2	64	HB.24.AGD	1-1102340-6	143
HA.16.Sti.S.B33-48	1-1103416-8	152	HA-K.3.AG-LB	2-1102105-2	49	HB.24.AGD-LB	1-1102340-2	145
HA.16.Sti.S.B33-48	1-1103416-8	166	HA-K.3.AGW-LB	2-1102107-2	49	HB.24.AG-LB	1-1102291-2	145
HA.16.Sti.S.B49-64	1-1103416-9	166	HA-K.3.STO.1.11.Z	2-1102101-7	49	HB.24.AG-VS	1-1102291-1	140
HA.16.Sti.SC.B1-16	7-1103416-1	100	HA-K.3.STO.1.M16.Z	0-1106405-2	46	HB.24.KDO-LB.1.21.G	1-1102336-2	147
HA.16.Sti.SC.B1-16	7-1103416-1	127	Handtool 2,5 mm Contact	734285-1	36	HB.24.KDO-LB.1.29.G	1-1102339-2	147
HA.16.Sti.SC.B1-16	7-1103416-1	152	Handtool 2,5 mm Contact	734285-2	36	HB.24.KDO-LB.1.M32.G	0-1106463-1	147
HA.16.Sti.SC.B1-16	7-1103416-1	166	Handtool 2,5 mm Contact	734285-3	36	HB.24.KDO-VS.1.21.G	1-1102336-1	141
HA.16.Sti.SC.B17-32	7-1103416-7	127	HB.10.AGD	1-1102283-6	91	HB.24.KDO-VS.1.29.G	1-1102339-1	141
HA.16.Sti.SC.B17-32	7-1103416-7	152	HB.10.AGD-LB	1-1102283-2	93	HB.24.KDO-VS.1.M32.G	0-1106463-2	141
HA.16.Sti.SC.B17-32	7-1103416-7	166	HB.10.AG-LB	1-1102271-2	93	HB.24.SGD.1.21.Z	1-1102343-6	143
HA.16.Sti.SC.B33-48	7-1103416-8	152	HB.10.AG-VS	1-1102271-1	88	HB.24.SGD.2.21.Z	1-1102345-6	143
HA.16.Sti.SC.B33-48	7-1103416-8	166	HB.10.KDO-LB.1.16.G	1-1102279-2	94	HB.24.SGD.2.M25.Z	0-1106464-1	143
HA.16.Sti.SC.B49-64	7-1103416-9	166	HB.10.KDO-LB.1.21.G	1-1102282-2	94	HB.24.SGD-LB.1.21.Z	1-1102343-2	146
HA.16.STO.1.16.G	1-1102139-7	103	HB.10.KDO-LB.1.M25.G	0-1106428-1	94	HB.24.SGD-LB.2.21.Z	1-1102345-2	146
HA.16.STO.1.M20.G	0-1106439-1	103	HB.10.KDO-VS.1.16.G	1-1102279-1	89	HB.24.SGD-LB.2.M25.Z	0-1106464-2	146
HA.16.STS.1.16.G	1-1102136-7	103	HB.10.KDO-VS.1.21.G	1-1102274-2	93	HB.24.SG-LB.1.21.Z	1-1102331-2	146
HA.16.STS.1.M20.G	0-1106439-2	103	HB.10.KDO-VS.1.M25.G	0-1106428-2	89	HB.24.SG-LB.2.21.Z	1-1102333-2	146
HA.3.AGD-LB	1-1102106-2	49	HB.10.SGD.1.16.Z	1-1102286-6	91	HB.24.SG-LB.2.M25.Z	0-1106464-3	146
HA.3.AG-LB	1-1102105-2	49	HB.10.SGD.2.16.Z	1-1102288-6	91	HB.24.SG-VS.1.21.Z	1-1102331-1	141
HA.3.AGW-LB	1-1102107-2	49	HB.10.SGD.2.M25.Z	0-1106429-1	91	HB.24.SG-VS.2.21.Z	1-1102333-1	141
HA.3.Bu.S	1-1103401-1	45	HB.10.SGD-LB.1.16.Z	1-1102286-2	94	HB.24.SG-VS.2.M25.Z	0-1106464-4	141
HA.3.EG-LB/A.1.16.Z	1-1102114-2	50	HB.10.SGD-LB.2.16.Z	1-1102288-2	94	HB.24.SKP-LB	3-1106216-0	184
HA.3.EG-LB/A.1.M20.Z	0-1102874-1	50	HB.10.SGD-LB.2.M25.Z	0-1106429-2	94	HB.24.SKP-VS	2-1106216-0	184
HA.3.KDOD-LB.1.11.Z	1-1108759-2	50	HB.10.SG-LB.1.16.Z	1-1102274-2	93	HB.24.SKP-VS+D	2-1106216-1	184
HA.3.KDO-LB.1.11.Z	1-1102112-2	50	HB.10.SG-LB.2.16.Z	1-1102276-2	93	HB.24.STO.1.21.G	1-1102325-6	140
HA.3.KDO-LB.1.M16.Z	0-1106403-1	50	HB.10.SG-LB.2.M25.Z	0-1106429-3	93	HB.24.STO.1.29.G	1-1102328-6	140
HA.3.SG-LB.1.11.G	1-1102110-2	50	HB.10.SG-VS.1.16.Z	1-1102274-1	88	HB.24.STO.1.M32.G	0-1106465-1	140

Sortiert nach Bezeichnung/Sorted by description

Bestelltext	Best-Nr.	Seite	Bestelltext	Best-Nr.	Seite	Bestelltext	Best-Nr.	Seite
HB.24.STO-GR.1.21.G	1-1102325-7	145	HB-K.10.SGD-LB.1.16.Z	2-1102286-2	94	HB-K.32.SGD.2.M32.Z	0-1106476-5	162
HB.24.STO-GR.1.29.G	1-1102328-7	145	HB-K.10.SGD-LB.2.16.Z	2-1102288-2	94	HB-K.32.SG-VS.1.29.Z	2-1102354-1	161
HB.24.STO-GR.1.M32.G	0-1106465-2	145	HB-K.10.SGD-LB.2.M25.Z	0-1106429-6	94	HB-K.32.SG-VS.2.29.Z	2-1102356-1	161
HB.24.STO-VS.1.21.G	1-1102325-1	142	HB-K.10.SG-LB.1.16.Z	2-1102274-2	93	HB-K.32.SG-VS.2.M32.Z	0-1106476-8	161
HB.24.STO-VS.1.29.G	1-1102328-1	142	HB-K.10.SG-LB.2.M25.Z	0-1106429-7	93	HB-K.32.STO.1.29.G	2-1102351-6	160
HB.24.STO-VS.1.M32.G	0-1106465-3	142	HB-K.10.SG-VS.1.16.Z	2-1102274-1	88	HB-K.32.STO.1.M40.G	0-1106477-7	160
HB.24.STS.1.21.G	1-1102316-6	139	HB-K.10.SG-VS.2.16.Z	2-1102276-1	88	HB-K.32.STO-GR.1.29.G	2-1102351-7	163
HB.24.STS.1.29.G	1-1102319-6	139	HB-K.10.SG-VS.2.M25.Z	0-1106429-8	88	HB-K.32.STO-GR.1.M40.G	0-1106477-8	163
HB.24.STS.1.M32.G	0-1106465-4	139	HB-K.10.STO.1.16.G	2-1102267-6	87	HB-K.32.STS.1.29.G	2-1102348-6	160
HB.24.STS-GR.1.21.G	1-1102316-7	144	HB-K.10.STO.1.21.G	2-1102270-6	87	HB-K.32.STS.1.M40.G	1-1106477-0	160
HB.24.STS-GR.1.29.G	1-1102319-7	144	HB-K.10.STO.1.M25.G	0-1106430-7	87	HB-K.32.STS-GR.1.29.G	2-1102348-7	163
HB.24.STS-GR.1.M32.G	0-1106465-5	144	HB-K.10.STO-GR.1.16.G	2-1102267-7	92	HB-K.32.STS-GR.1.M40.G	1-1106477-1	163
HB.24.STS-VS.1.21.G	1-1102316-1	142	HB-K.10.STO-GR.1.M25.G	0-1106430-8	92	HB-K.32.STS-VS.1.M40.G	1-1106477-2	162
HB.24.STS-VS.1.29.G	1-1102319-1	142	HB-K.10.STO-VS.1.16.G	2-1102267-1	90	HB-K.48.AGD-LB	2-1102389-2	173
HB.24.STS-VS.1.M32.G	0-1106465-6	142	HB-K.10.STO-VS.1.M25.G	0-1106430-9	90	HB-K.48.SGD-LB.1.36.Z	2-1107005-2	173
HB.32.AGD	1-1102360-6	162	HB-K.10.STS.1.16.G	2-1102261-6	87	HB-K.48.SGD-LB.2.36.Z	2-1107007-2	173
HB.32.AGD-LB	1-1102360-2	164	HB-K.10.STS.1.21.G	2-1102264-6	87	HB-K.48.SG-LB.1.36.Z	2-1102395-2	173
HB.32.AG-LB	1-1102352-2	164	HB-K.10.STS.1.M25.G	1-1106430-0	87	HB-K.48.SG-LB.2.36.Z	2-1102397-2	173
HB.32.AG-VS	1-1102352-1	160	HB-K.10.STS-GR.1.16	2-1102259-7	92	HB-K.48.SG-LB.2.M40.Z	0-1106481-4	173
HB.32.KDO-VS.1.29.G	1-1102359-1	161	HB-K.10.STS-GR.1.16.G	2-1102261-7	92	HB-K.48.STO-GR.1.36.G	2-1102385-7	172
HB.32.KDO-VS.1.M40.G	0-1106475-2	161	HB-K.10.STS-VS.1.16.G	2-1102261-1	90	HB-K.48.STO-GR.1.M50.G	0-1106482-6	172
HB.32.SGD.1.29.Z	1-1102362-6	162	HB-K.10.STS-VS.1.M25.G	1-1106430-2	90	HB-K.48.STS-GR.1.36.G	2-1102376-7	172
HB.32.SGD.2.29.Z	1-1102364-6	162	HB-K.16.AGD	2-1102305-6	119	HB-K.48.STS-GR.1.M50.G	0-1106482-4	172
HB.32.SGD.2.M32.Z	0-1106476-1	162	HB-K.16.AGD-LB	2-1102305-2	121	HB-K.6.AGD-LB	2-1102246-2	74
HB.32.SGD-LB.1.29.Z	1-1102362-2	164	HB-K.16.AG-LB	2-1102296-2	121	HB-K.6.AG-LB	2-1102244-2	74
HB.32.SGD-LB.2.M32.Z	0-1106476-2	164	HB-K.16.AG-VS	2-1102296-1	116	HB-K.6.KDO-LB.1.16.G	2-1102258-2	76
HB.32.SG-VS.1.29.Z	1-1102354-1	161	HB-K.16.KDO-VS.1.21.G	2-1102304-1	117	HB-K.6.KDO-LB.1.M25.G	0-1106417-2	76
HB.32.SG-VS.2.29.Z	1-1102356-1	161	HB-K.16.KDO-VS.1.M32.G	0-1106447-4	117	HB-K.6.SGD-LB.1.16.Z	2-1102253-2	75
HB.32.SG-VS.2.M32.Z	0-1106476-4	161	HB-K.16.SGD.1.21.Z	2-1102308-6	119	HB-K.6.SGD-LB.2.16.Z	2-1102255-2	75
HB.32.STO.1.29.G	1-1102351-6	160	HB-K.16.SGD.2.21.Z	2-1102310-6	119	HB-K.6.SGD-LB.2.M25.Z	0-1106418-3	75
HB.32.STO.1.M40.G	0-1106477-1	160	HB-K.16.SGD.2.M25.Z	0-1106448-5	119	HB-K.6.SG-LB.1.16.Z	2-1102249-2	74
HB.32.STO-GR.1.29.G	1-1102351-7	163	HB-K.16.SGD-LB.1.21.Z	2-1102308-2	122	HB-K.6.SG-LB.2.16.Z	2-1102251-2	74
HB.32.STO-GR.1.M40.G	0-1106477-2	163	HB-K.16.SGD-LB.2.21.Z	2-1102310-2	122	HB-K.6.SG-LB.2.M25.Z	0-1106418-4	74
HB.32.STS.1.29.G	1-1102348-6	160	HB-K.16.SGD-LB.2.M25.Z	0-1106448-6	122	HB-K.6.STO.1.16.G	2-1102243-7	73
HB.32.STS.1.M40.G	0-1106477-4	160	HB-K.16.SG-LB.2.M25.Z	0-1106448-7	121	HB-K.6.STO.1.M25.G	0-1106419-3	73
HB.32.STS-GR.1.29.G	1-1102348-7	163	HB-K.16.SG-VS.1.21.Z	2-1102299-1	116	HB-K.6.STS.1.13.G	0-1108573-5	73
HB.32.STS-GR.1.M40.G	0-1106477-5	163	HB-K.16.SG-VS.2.21.Z	2-1102301-1	116	HB-K.6.STS.1.16.G	2-1102240-7	73
HB.32.STS-VS.1.29.G	1-1102348-1	162	HB-K.16.SG-VS.2.M25.Z	0-1106448-9	116	HB-K.6.STS.1.M25.G	0-1106419-4	73
HB.32.STS-VS.1.M40.G	0-1106477-6	162	HB-K.16.STO.1.21.G	2-1102295-6	115	HB-K/Z.10.AG-ZVGR	2-1102271-8	96
HB.48.AGD-LB	1-1102389-2	173	HB-K.16.STO.1.M32.G	0-1106449-7	115	HB-K/Z.10.SG-ZVGR.1.16.Z	2-1102274-8	97
HB.48.SGD-LB.1.29.Z	1-1107001-2	173	HB-K.16.STO-GR.1.21.G	2-1102295-7	120	HB-K/Z.10.SG-ZVGR.2.16.Z	2-1102276-8	97
HB.48.SGD-LB.1.36.Z	1-1107005-2	173	HB-K.16.STO-GR.1.M32.G	0-1106449-8	120	HB-K/Z.10.SG-ZVGR.2.M25.Z	0-1106429-9	97
HB.48.SGD-LB.2.29.Z	1-1107003-2	173	HB-K.16.STO-VS.1.M32.G	0-1106449-9	118	HB-K/Z.10.STS-ZB.1.16.G	2-1102261-3	96
HB.48.SGD-LB.2.36.Z	1-1107007-2	173	HB-K.16.STS.1.21.G	2-1102292-6	115	HB-K/Z.10.STS-ZB.1.M25.G	1-1106430-4	96
HB.48.SGD-LB.2.M40.Z	0-1106481-1	173	HB-K.16.STS.1.M32.G	1-1106449-0	115	HB-K/Z.16.AG-ZVGR	2-1102296-8	123
HB.48.SG-LB.1.29.Z	1-1102391-2	173	HB-K.16.STS-GR.1.21.G	2-1102292-7	120	HB-K/Z.16.SG-ZVGR.1.21.Z	2-1102299-8	124
HB.48.SG-LB.1.36.Z	1-1102395-2	173	HB-K.16.STS-GR.1.M32.G	1-1106449-1	120	HB-K/Z.16.SG-ZVGR.2.21.Z	2-1102301-8	124
HB.48.SG-LB.2.29.Z	1-1102393-2	173	HB-K.16.STS-VS.1.M32.G	1-1106449-2	118	HB-K/Z.16.SG-ZVGR.2.M25.Z	1-1106448-0	124
HB.48.SG-LB.2.36.Z	1-1102397-2	173	HB-K.24.AGD	2-1102340-6	143	HB-K/Z.16.STS-ZB.1.21.G	2-1102292-3	123
HB.48.SG-LB.2.M40.Z	0-1106481-2	173	HB-K.24.AGD-LB	2-1102340-2	145	HB-K/Z.16.SG-ZVGR.1.M32.G	1-1106449-4	123
HB.48.STO-GR.1.29.G	1-1102382-7	172	HB-K.24.AG-LB	2-1102291-2	145	HB-K/Z.24.AG-ZVGR	2-1102291-8	149
HB.48.STO-GR.1.36.G	1-1102385-7	172	HB-K.24.AG-VS	2-1102291-1	140	HB-K/Z.24.SG-ZVGR.1.21.Z	2-1102331-8	149
HB.48.STO-GR.1.42.G	1-1102388-7	172	HB-K.24.KDO-LB.1.M32.G	0-1106463-3	147	HB-K/Z.24.SG-ZVGR.2.21.Z	2-1102331-8	149
HB.48.STO-GR.1.M50.G	0-1106482-1	172	HB-K.24.KDO-VS.1.21.G	2-1102336-1	141	HB-K/Z.24.SG-ZVGR.2.M25.Z	2-1102316-3	148
HB.48.STS-GR.1.29.G	1-1102373-7	172	HB-K.24.SGD.1.21.Z	2-1102343-6	143	HB-K/Z.24.SG-ZVGR.2.M32.G	1-1106465-5	148
HB.48.STS-GR.1.36.G	1-1102376-7	172	HB-K.24.SGD.2.M25.G	0-1106464-5	143	HB-K/Z.32.AG-ZVGR	2-1102352-8	165
HB.48.STS-GR.1.42.G	1-1102379-7	172	HB-K.24.SGD-LB.1.21.Z	2-1102343-2	146	HB-K/Z.32.SG-ZVGR.1.29.G	2-1102348-3	165
HB.48.STS-GR.1.M50.G	0-1106482-2	172	HB-K.24.SGD-LB.2.M25.Z	0-1106464-6	146	HB-K/Z.32.SG-ZVGR.1.M40.G	1-1106477-4	165
HB.6.AGD-LB	1-1102246-2	74	HB-K.24.SG-LB.1.21.Z	2-1102331-2	146	HB-K/Z.32.SG-ZVGR.2.M25.Z	2-1102377-8	174
HB.6.AG-LB	1-1102244-2	74	HB-K.24.SG-LB.2.M25.Z	0-1106464-7	146	HB-K/Z.48.SG-ZVGR	2-1102234-3	174
HB.6.KDO-LB.1.16.G	1-1102258-2	76	HB-K.24.SG-VS.1.21.Z	2-1102331-1	141	HB-K/Z.48.SG-ZVGR.1.42.Z	2-1102233-3	174
HB.6.KDO-LB.1.M25.G	0-1106417-1	76	HB-K.24.SG-VS.2.21.Z	2-1102333-1	141	HB-K/Z.48.SG-ZVGR.2.16.Z	2-1102236-3	174
HB.6.SGD-LB.1.16.Z	1-1102253-2	75	HB-K.24.SG-VS.2.M25.Z	0-1106464-8	141	HB-K/Z.48.SG-ZVGR.2.M25.Z	2-1102235-3	174
HB.6.SGD-LB.2.16.Z	1-1102255-2	75	HB-K.24.STO.1.21.G	2-1102325-6	140	HB-K/Z.6.AG-ZVGR	2-1102244-8	77
HB.6.SGD-LB.2.M25.Z	0-1106418-1	75	HB-K.24.STO.1.29.G	2-1102328-6	140	HB-K/Z.6.SG-ZVGR.1.16.Z	2-1102249-8	78
HB.6.SG-LB.1.16.Z	1-1102249-2	74	HB-K.24.STO.1.M32.G	0-1106465-7	140	HB-K/Z.6.SG-ZVGR.2.16.Z	2-1102251-8	78
HB.6.SG-LB.2.16.Z	1-1102251-2	74	HB-K.24.STO-GR.1.29.G	2-1102328-7	145	HB-K/Z.6.SG-ZVGR.2.M25.Z	0-1106418-5	78
HB.6.SG-LB.2.M25.Z	0-1106418-2	74	HB-K.24.STO-GR.1.M32.G	0-1106465-8	145	HB-K/Z.6.SG-ZVGR.2.M32.G	2-1102240-3	77
HB.6.SKP	5-1106207-7	184	HB-K.24.STO-VS.1.M32.G	1-1106465-0	142	HB-K/Z.6.SG-ZVGR.2.M50.G	0-1106419-5	77
HB.6.STO.1.16.G	1-1102243-7	73	HB-K.24.STS.1.21.G	2-1102316-6	139	HB-KF.10.SG-ZVGR.1.16.Z	1-1102211-6	87
HB.6.STO.1.M25.G	0-1106419-1	73	HB-K.24.STS.1.29.G	2-1102319-6	139	HB-KF.10.SG-ZVGR.2.16.Z	2-1102214-6	87
HB.6.STS.1.16.G	1-1102240-7	73	HB-K.24.STS.1.M32.G	1-1106465-1	139	HB-KF.10.SG-ZVGR.2.M25.Z	2-1102211-7	92
HB.6.STS.1.M25.G	0-1106419-2	73	HB-K.24.STS-GR.1.21.G	2-1102316-7	144	HB-KF.10.SG-ZVGR.2.M50.G	0-1106431-1	87
HB-K.10.AGD	2-1102283-6	91	HB-K.24.STS-GR.1.29.G	2-1102319-7	144	HB-KF.10.SG-ZVGR.2.M50.G	0-1106431-2	90
HB-K.10.AGD-LB	2-1102283-2	93	HB-K.24.STS-GR.1.M32.G	1-1106465-2	144	HB-KF.10.SG-ZVGR.2.M50.G	1-1102211-1	92
HB-K.10.AG-LB	2-1102271-2	93	HB-K.24.STS-VS.1.29.G	2-1102319-1	142	HB-KF.10.SG-ZVGR.2.M50.G	0-1106431-3	90
HB-K.10.AG-VS	2-1102271-1	88	HB-K.24.STS-VS.1.M32.G	1-1106465-3	142	HB-KF.16.SG-ZVGR.1.21.Z	1-1102220-6	115
HB-K.10.KDO-VS.1.16.G	2-1102279-1	89	HB-K.32.AGD	2-1102360-6	162	HB-KF.6.SG-ZVGR.1.16.Z	1-1102205-7	73
HB-K.10.KDO-VS.1.M25.G	0-1106428-4	89	HB-K.32.AGD-LB	2-1102360-2	164	HB-KF.6.SG-ZVGR.1.M25.G	0-1106420-1	73
HB-K.10.SGD.1.16.Z	2-1102286-6	91	HB-K.32.AG-LB	2-1102352-2	164	HB-KF.10.SG-ZVGR.1.16.G	2-1102211-6	87
HB-K.10.SGD.2.M25.Z	0-1106429-5	91	HB-K.32.AG-VS	2-1102352-1	160	HB-KF.10.SG-ZVGR.1.M25.G	0-1106431-5	87

Sortiert nach Bezeichnung/Sorted by description

Bestelltext	Best-Nr.	Seite	Bestelltext	Best-Nr.	Seite	Bestelltext	Best-Nr.	Seite
HB-KF/K.10.STS-GR.1.16.G	2-1102211-7	92	HD.15.STO.1.M25.G	0-1106414-1	63	HD.40.KDO-LB.1.29.G	1-1102587-2	122
HB-KF/K.10.STS-VS.1.16.G	2-1102211-1	90	HD.15.STS.1.16.G	1-1102427-7	63	HD.40.KDO-LB.1.M32.G	0-1106450-1	122
HB-KF/K.10.STS-VS.1.M25.G	0-1106431-7	90	HD.15.STS.1.21.G	1-1102430-7	63	HD.40.KDO-VS.1.21.G	1-1102584-1	117
HB-KF/K.10.STS-VS.1.M25.G	0-1106431-7	92	HD.15.STS.1.M25.G	0-1106414-2	63	HD.40.KDO-VS.1.29.G	1-1102587-1	117
HB-KF/K.16.STS.1.M32.G	1-1106449-8	115	HD.16.Bu.C	2-1103007-3	69	HD.40.KDO-VS.1.M32.G	0-1106450-2	117
HB-KF/K.6.STS.1.16.G	2-1102205-7	73	HD.16.KDO-LB.1.21.G	1-1102489-2	76	HD.40.SGD.1.21.Z	1-1102589-6	119
HB-KF/K.6.STS.1.M25.G	0-1102899-1	73	HD.16.KDO-LB.1.M32.G	0-1106421-1	76	HD.40.SGD.1.29.Z	1-1102593-6	119
HB-KF/K-Z.10.STS-ZB.1.16.G	2-1102211-3	96	HD.16.SGD-LB.1.21.Z	1-1102480-2	75	HD.40.SGD.2.21.Z	1-1102591-6	119
HB-KF/K-Z.10.STS-ZB.1.M25.G	0-1106431-8	96	HD.16.SGD-LB.2.21.Z	1-1102482-2	75	HD.40.SGD.2.29.Z	1-1102595-6	119
HB-KF/K-Z.16.STS-ZB.1.21.G	2-1102220-3	123	HD.16.SGD-LB.2.M32.Z	0-1106422-1	75	HD.40.SGD.2.M32.Z	0-1106451-1	119
HB-KF/K-Z.16.STS-ZB.1.M32.G	2-1106449-1	123	HD.16.SG-LB.1.21.Z	1-1102472-2	75	HD.40.SGD-LB.1.21.Z	1-1102589-2	122
HB-KF/K-Z.24.STS-ZB.1.29.G	2-1102232-3	148	HD.16.SG-LB.2.21.Z	1-1102474-2	75	HD.40.SGD-LB.1.29.Z	1-1102593-2	122
HB-KF/K-Z.24.STS-ZB.1.M32.G	0-1106466-7	148	HD.16.SG-LB.2.M32.Z	0-1106422-2	75	HD.40.SGD-LB.2.21.Z	1-1102591-2	122
HB-KF/K-Z.6.STS-ZB.1.16.G	2-1102205-3	77	HD.16.Sti.C	2-1103006-3	69	HD.40.SGD-LB.2.29.Z	1-1102595-2	122
HB-KF/K-Z.6.STS-ZB.1.M25.G	0-1106420-2	77	HD.16.STO.1.21.G	1-1102467-7	74	HD.40.SGD-LB.2.M32.Z	0-1106451-2	122
HB-KF-Z.10.STS-ZB.1.16.G	1-1102211-3	96	HD.16.STO.1.M32.G	0-1106423-1	74	HD.40.SG-LB.1.21.Z	1-1102575-2	121
HB-KF-Z.10.STS-ZB.1.M25.G	0-1106431-4	96	HD.16.SG-LB.1.21.G	1-1102462-7	73	HD.40.SG-LB.1.29.Z	1-1102579-2	121
HB-KF-Z.16.STS-ZB.1.21.G	1-1102220-3	123	HD.16.SG-LB.2.21.Z	0-1106423-2	73	HD.40.SG-LB.2.21.Z	1-1102577-2	121
HB-KF-Z.16.STS-ZB.1.M32.G	2-1106449-2	123	HD.24.Bu.C	2-1103009-3	84	HD.40.SG-LB.2.29.Z	1-1102581-2	121
HB-KF-Z.24.STS-ZB.1.21.G	1-1102229-3	148	HD.24.KDO-LB.1.29.G	1-1102519-2	94	HD.40.SG-LB.2.M32.Z	0-1106451-3	121
HB-KF-Z.24.STS-ZB.1.29.G	1-1102232-3	148	HD.24.KDO-LB.1.M32.G	0-1106432-1	94	HD.40.SG-VS.1.21.Z	1-1102575-1	116
HB-KF-Z.24.STS-ZB.1.M32.G	0-1106466-8	148	HD.24.KDO-VS.1.M32.G	0-1106432-2	89	HD.40.SG-VS.1.29.Z	1-1102579-1	116
HB-KF-Z.6.STS-ZB.1.16.G	1-1102205-3	77	HD.24.SGD.2.21.Z	1-1102523-6	91	HD.40.SG-VS.2.21.Z	1-1102577-1	116
HB-KF-Z.6.STS-ZB.1.M25.G	0-1106420-3	77	HD.24.SGD.2.M32.Z	0-1106433-1	91	HD.40.SG-VS.2.29.Z	1-1102581-1	116
HB-Z.10.AG-ZVGR	1-1102271-8	96	HD.24.SGD-LB.1.29.Z	1-1102525-2	94	HD.40.SG-VS.2.M32.Z	0-1106451-4	116
HB-Z.10.SG-ZVGR.1.16.Z	1-1102274-8	97	HD.24.SGD-LB.2.21.Z	1-1102523-2	94	HD.40.Sti.C	2-1103012-3	110
HB-Z.10.SG-ZVGR.2.16.Z	1-1102276-8	97	HD.24.SGD-LB.2.29.Z	1-1102527-2	94	HD.40.Sti.C	2-1103012-3	158
HB-Z.10.STS-ZB.1.16.G	1-1102261-3	96	HD.24.SGD-LB.2.M32.Z	0-1106433-2	94	HD.40.STO.1.21.G	1-1102570-6	116
HB-Z.10.STS-ZB.1.M25.G	1-1106430-6	96	HD.24.SG-LB.1.21.Z	1-1102507-2	93	HD.40.STO.1.29.G	1-1102573-6	116
HB-Z.16.AG-ZVGR	1-1102296-8	123	HD.24.SG-LB.1.29.Z	1-1102511-2	93	HD.40.STO.1.M32.G	0-1106452-1	116
HB-Z.16.SG-ZVGR.1.21.Z	1-1102299-8	124	HD.24.SG-LB.2.21.Z	1-1102509-2	93	HD.40.STO.1.M40.G	0-1102920-1	116
HB-Z.16.SG-ZVGR.2.21.Z	1-1102301-8	124	HD.24.SG-LB.2.29.Z	1-1102513-2	93	HD.40.STO-GR.1.21.G	1-1102570-7	120
HB-Z.16.SG-ZVGR.2.M25.Z	1-1106448-1	124	HD.24.SG-LB.2.M32.Z	0-1106433-3	93	HD.40.STO-GR.1.29.G	1-1102573-7	120
HB-Z.16.STS-ZB.1.21.G	1-1102292-3	123	HD.24.SG-VS.1.21.Z	1-1102507-1	88	HD.40.STO-GR.1.M32.G	0-1106452-2	120
HB-Z.16.STS-ZB.1.M32.G	2-1106449-4	123	HD.24.SG-VS.1.29.Z	1-1102511-1	88	HD.40.STO-VS.1.21.G	1-1102570-1	118
HB-Z.24.AG-ZVGR	1-1102291-8	149	HD.24.SG-VS.2.21.Z	1-1102509-1	88	HD.40.STO-VS.1.29.G	1-1102573-1	118
HB-Z.24.SG-ZVGR.1.21.Z	1-1102331-8	149	HD.24.SG-VS.2.29.Z	1-1102513-1	88	HD.40.STO-VS.1.M32.G	0-1106452-3	118
HB-Z.24.SG-ZVGR.2.21.Z	1-1102333-8	149	HD.24.SG-VS.2.M32.Z	0-1106433-4	88	HD.40.STS.1.21.G	1-1102564-6	115
HB-Z.24.SG-ZVGR.2.M25.Z	1-1106464-0	149	HD.24.Sti.C	2-1103008-3	84	HD.40.STS.1.29.G	1-1102567-6	115
HB-Z.24.STS-ZB.1.21.G	1-1102316-3	148	HD.24.STO.1.21.G	1-1102502-6	87	HD.40.STS.1.M32.G	0-1106452-4	115
HB-Z.24.STS-ZB.1.29.G	1-1102319-3	148	HD.24.STO.1.29.G	1-1102505-6	87	HD.40.STS.1.M40.G	1-1106452-7	115
HB-Z.24.STS-ZB.1.M32.G	1-1106465-9	148	HD.24.STO.1.M32.G	1-1106434-1	87	HD.40.STS-GR.1.21.G	1-1102564-7	120
HB-Z.32.AG-ZVGR	1-1102352-8	165	HD.24.STO-GR.1.21.G	1-1102502-7	92	HD.40.STS-GR.1.29.G	1-1102567-7	120
HB-Z.32.SG-ZVGR.1.29.Z	1-1102354-8	165	HD.24.STO-GR.1.29.G	1-1102505-7	92	HD.40.STS-GR.1.M32.G	0-1106452-5	120
HB-Z.32.SG-ZVGR.2.29.Z	1-1102356-8	165	HD.24.STO-GR.1.M32.G	0-1106434-2	92	HD.40.STS-VS.1.21.G	1-1102564-1	118
HB-Z.32.STS-ZB.1.29.G	1-1102348-3	165	HD.24.STO-VS.1.29.G	1-1102505-1	90	HD.40.STS-VS.1.29.G	1-1102567-1	118
HB-Z.32.STS-ZB.1.M40.G	1-1106477-6	165	HD.24.STO-VS.1.M32.G	0-1106434-3	90	HD.40.STS-VS.1.M32.G	0-1106452-6	118
HB-Z.48.AG-ZVGR	1-1102237-8	174	HD.24.STS.1.21.G	1-1102496-6	87	HD.50.STO.1.M40.G	0-1106459-1	130
HB-Z.48.STS-ZB.1.42.G	1-1102234-3	174	HD.24.STS.1.29.G	1-1102499-6	87	HD.50.STO-VS.1.M40.G	0-1106459-2	131
HB-Z.48.STS-ZB.1.42.Z	1-1102233-3	174	HD.24.STS.1.M32.G	0-1106434-4	87	HD.50.STS.1.M40.G	0-1106459-3	130
HB-Z.48.STS-ZB.1.48.G	1-1102236-3	174	HD.24.STS-GR.1.21.G	1-1102496-7	92	HD.50.STS-VS.1.M40.G	0-1106459-4	131
HB-Z.48.STS-ZB.1.48.Z	1-1102235-3	174	HD.24.STS-GR.1.M32.G	0-1106434-5	92	HD.64.Bu.C	2-1103033-3	136
HB-Z.6.AG-ZVGR	1-1102244-8	77	HD.24.STS-VS.1.21.G	1-1102496-1	90	HD.64.Bu.C	2-1103033-3	170
HB-Z.6.SG-ZVGR.1.16.Z	1-1102249-8	78	HD.24.STS-VS.1.29.G	1-1102499-1	90	HD.64.KDO-LB.1.21.G	1-1103355-2	147
HB-Z.6.SG-ZVGR.2.16.Z	1-1102251-8	78	HD.24.STS-VS.1.M25.G	1-1106434-5	90	HD.64.KDO-LB.1.29.G	1-1103358-2	147
HB-Z.6.SG-ZVGR.2.M25.Z	0-1106418-6	78	HD.24.STS-VS.1.M32.G	0-1106434-6	90	HD.64.KDO-LB.1.M32.G	0-1106468-1	147
HB-Z.6.STS-ZB.1.16.G	1-1102240-3	77	HD.25.Bu.C	2-1103011-3	129	HD.64.KDO-VS.1.21.G	1-1103355-1	141
HB-Z.6.STS-ZB.1.M25.G	0-1106419-6	77	HD.25.Bu.C	2-1103011-3	129	HD.64.KDO-VS.1.29.G	1-1103358-1	141
HD.108.STO.1.36.G	1-1102414-6	140	HD.25.KDO-LB.1.21.G	1-1102561-2	105	HD.64.KDO-VS.1.M32.G	0-1106468-2	141
HD.108.STO.1.M50.G	0-1106467-1	140	HD.25.KDO-LB.1.M25.G	0-1106440-1	105	HD.64.SGD.1.21.Z	1-1103360-6	143
HD.108.STS.1.29.G	1-1102411-6	139	HD.25.SGD-LB.1.16.Z	1-1102549-2	105	HD.64.SGD.1.29.Z	1-1103364-6	143
HD.108.STS.1.M50.G	0-1106467-4	139	HD.25.SGD-LB.1.21.Z	1-1102553-2	105	HD.64.SGD.2.21.Z	1-1103362-6	143
HD.108.STS-GR.1.29.G	1-1102411-7	144	HD.25.SGD-LB.2.16.Z	1-1102551-2	105	HD.64.SGD.2.29.Z	1-1103366-6	143
HD.108.STS-GR.1.M50.G	0-1106467-5	144	HD.25.SGD-LB.2.21.Z	1-1102555-2	105	HD.64.SGD.2.M32.Z	0-1106469-1	143
HD.15.Bu.C	2-1103005-3	62	HD.25.SGD-LB.2.M25.Z	0-1106441-1	105	HD.64.SGD-LB.1.21.Z	1-1103360-2	146
HD.15.KDO-LB.1.16.G	1-1102455-2	65	HD.25.SG-LB.1.16.Z	1-1102541-2	104	HD.64.SGD-LB.1.29.Z	1-1103364-2	146
HD.15.KDO-LB.1.21.G	1-1102458-2	65	HD.25.SG-LB.1.21.Z	1-1102545-2	104	HD.64.SGD-LB.2.21.Z	1-1103362-2	146
HD.15.KDO-LB.1.M25.G	0-1106412-1	65	HD.25.SG-LB.2.16.Z	1-1102543-2	104	HD.64.SGD-LB.2.29.Z	1-1103366-2	146
HD.15.SGD-LB.1.16.Z	1-1102446-2	65	HD.25.SG-LB.2.21.Z	1-1102547-2	104	HD.64.SGD-LB.2.M32.Z	0-1106469-2	146
HD.15.SGD-LB.1.21.Z	1-1102450-2	65	HD.25.SG-LB.2.M25.Z	0-1106441-2	104	HD.64.SG-LB.1.21.Z	1-1103346-2	146
HD.15.SGD-LB.2.16.Z	1-1102448-2	65	HD.25.Sti.C	2-1103010-3	102	HD.64.SG-LB.1.29.Z	1-1103350-2	146
HD.15.SGD-LB.2.21.Z	1-1102452-2	65	HD.25.Sti.C	2-1103010-3	129	HD.64.SG-LB.2.21.Z	1-1103348-2	146
HD.15.SGD-LB.2.M25.Z	0-1106413-1	65	HD.25.STO.1.16.G	1-1102536-7	103	HD.64.SG-LB.2.29.Z	1-1103352-2	146
HD.15.SG-LB.1.16.Z	1-1102438-2	64	HD.25.STO.1.21.G	1-1102539-7	103	HD.64.SG-LB.2.M32.Z	0-1106469-3	146
HD.15.SG-LB.1.21.Z	1-1102442-2	64	HD.25.STO.1.M25.G	0-1106442-1	103	HD.64.SG-VS.1.21.Z	1-1103346-1	141
HD.15.SG-LB.2.16.Z	1-1102440-2	64	HD.25.STS.1.16.G	1-1102530-7	103	HD.64.SG-VS.1.29.Z	1-1103350-1	141
HD.15.SG-LB.2.21.Z	1-1102444-2	64	HD.25.STS.1.21.G	1-1102533-7	103	HD.64.SG-VS.2.21.Z	1-1103348-1	141
HD.15.SG-LB.2.M25.Z	0-1106413-2	64	HD.25.STS.1.M25.G	0-1106442-2	103	HD.64.SG-VS.2.29.Z	1-1103352-1	141
HD.15.Sti.C	2-1103004-3	62	HD.40.Bu.C	2-1103013-3	110	HD.64.SG-VS.2.M32.Z	0-1106469-4	141
HD.15.STO.1.16.G	1-1102433-7	63	HD.40.Bu.C	2-1103013-3	158	HD.64.Sti.C	2-1103032-3	136
HD.15.STO.1.21.G	1-1102436-7	63	HD.40.KDO-LB.1.21.G	1-1102584-2	122	HD.64.Sti.C	2-1103032-3	170

Sortiert nach Bezeichnung/Sorted by description

Bestelltext	Best-Nr.	Seite	Bestelltext	Best-Nr.	Seite	Bestelltext	Best-Nr.	Seite
HD.64.STO.1.21.G	1-1103341-6	140	HD-K.24.SG-VS.1.21.Z	2-1102507-1	88	HD-K/Z.24.SG-ZVGR.2.29.Z	2-1102513-8	97
HD.64.STO.1.29.G	1-1103344-6	140	HD-K.24.SG-VS.1.29.Z	2-1102511-1	88	HD-K/Z.24.SG-ZVGR.2.M32.Z	0-1106469-9	97
HD.64.STO.1.M32.G	0-1106470-1	140	HD-K.24.SG-VS.2.21.Z	2-1102509-1	88	HD-K/Z.24.STS-ZB.1.21.G	2-1102496-3	96
HD.64.STO.1.M40.G	3-1106470-0	140	HD-K.24.SG-VS.2.M32.Z	0-1106433-8	88	HD-K/Z.24.STS-ZB.1.29.G	2-1102499-3	96
HD.64.STO-GR.1.21.G	1-1103341-7	145	HD-K.24.STO.1.21.G	2-1102502-6	87	HD-K/Z.40.SG-ZVGR.2.M32.Z	0-1106451-9	124
HD.64.STO-GR.1.29.G	1-1103344-7	145	HD-K.24.STO.1.29.G	2-1102505-6	87	HD-K/Z.40.STS-ZB.1.21.G	2-1102564-3	123
HD.64.STO-GR.1.M32.G	0-1106470-2	145	HD-K.24.STO.1.M32.G	0-1106434-7	87	HD-K/Z.40.STS-ZB.1.29.G	2-1102567-3	123
HD.64.STO-VS.1.21.G	1-1103341-1	142	HD-K.24.STO-GR.1.29.G	2-1102505-7	92	HD-K/Z.40.STS-ZB.1.M32.G	1-1106452-4	123
HD.64.STO-VS.1.29.G	1-1103344-1	142	HD-K.24.STO-GR.1.M32.G	0-1106434-8	92	HD-K/Z.64.SG-ZVGR.1.29.Z	2-1103350-8	149
HD.64.STO-VS.1.M32.G	0-1106470-3	142	HD-K.24.STO-VS.1.21.G	2-1102502-1	90	HD-K/Z.64.SG-ZVGR.2.29.Z	2-1103352-8	149
HD.64.STS.1.21.G	1-1103336-6	139	HD-K.24.STO-VS.1.29.G	2-1102505-1	90	HD-K/Z.64.SG-ZVGR.2.M32.Z	1-1106469-0	149
HD.64.STS.1.29.G	1-1103338-6	139	HD-K.24.STO-VS.1.M32.G	0-1106434-9	90	HD-K/Z.64.STS-ZB.1.29.G	2-1103338-3	148
HD.64.STS.1.M32.G	0-1106470-4	139	HD-K.24.STS.1.21.G	2-1102496-6	87	HD-K/Z.64.STS-ZB.1.M32.G	1-1106470-6	148
HD.64.STS.1.M40.G	1-1106470-9	139	HD-K.24.STS.1.29.G	2-1102499-6	87	HD-KF.40.STS.1.29.G	1-1102765-0	115
HD.64.STS-GR.1.21.G	1-1103336-7	144	HD-K.24.STS-GR.1.21.G	2-1102496-7	92	HD-KF.40.STS.1.M40.G	1-1102766-0	115
HD.64.STS-GR.1.29.G	1-1103338-7	144	HD-K.24.STS-GR.1.M32.G	1-1106434-1	92	HD-KF/K.40.STS.1.29.G	2-1102765-0	115
HD.64.STS-GR.1.M32.G	0-1106470-5	144	HD-K.24.STS-GR.1.21.G	2-1102496-1	90	HD-KF/K.40.STS.1.M40.G	2-1102766-0	115
HD.64.STS-GR.1.M40.G	3-1106470-5	144	HD-K.24.STS-VS.1.29.G	2-1102499-1	90	HD-KF/K-Z.64.STS-ZB.1.36.G	2-1102408-3	148
HD.64.STS-VS.1.21.G	1-1103336-1	142	HD-K.40.KDO-LB.1.M32.G	0-1106450-3	122	HD-KF-Z.64.STS-ZB.1.29.G	1-1102405-3	148
HD.64.STS-VS.1.29.G	1-1103338-1	142	HD-K.40.KDO-VS.1.29.G	2-1102587-1	117	HD-KF-Z.64.STS-ZB.1.36.G	1-1102408-3	148
HD.64.STS-VS.1.M32.G	0-1106470-6	142	HD-K.40.KDO-VS.1.M32.G	0-1106450-4	117	HD-KF-Z.64.STS-ZB.1.M40.G	0-1106471-9	148
HD.7.AG-LB	1-1102419-2	--	HD-K.40.SGD.1.21.Z	2-1102589-6	119	HD-Z.16.SG-ZVGR.1.21.Z	1-1102472-8	78
HD.7.AGW-LB	1-1102420-2	--	HD-K.40.SGD.2.21.Z	2-1102591-6	119	HD-Z.16.SG-ZVGR.2.21.Z	1-1102474-8	78
HD.7.Bu.C.B1-7	2-1103003-3	48	HD-K.40.SGD.2.M32.Z	0-1106451-5	119	HD-Z.16.SG-ZVGR.2.M32.Z	0-1106422-5	78
HD.7.Bu.C/250V	2-1103001-3	48	HD-K.40.SGD-LB.1.21.Z	2-1102589-2	122	HD-Z.16.STS-ZB.1.21.G	1-1102461-3	77
HD.7.KDO-LB.1.11.Z	1-1102424-2	--	HD-K.40.SGD-LB.1.29.Z	2-1102593-2	122	HD-Z.16.STS-ZB.1.M32.G	0-1106423-5	77
HD.7.KDO-LB.1.M20.Z	0-1102862-1	--	HD-K.40.SGD-LB.2.21.Z	2-1102591-2	122	HD-Z.24.SG-ZVGR.1.29.Z	1-1102511-8	97
HD.7.SG-LB.1.11.Z	1-1102422-2	--	HD-K.40.SGD-LB.2.29.Z	2-1102595-2	122	HD-Z.24.SG-ZVGR.2.29.Z	1-1102513-8	97
HD.7.SG-LB.1.M20.Z	0-1102860-1	--	HD-K.40.SGD-LB.2.M32.Z	0-1106451-6	122	HD-Z.24.SG-ZVGR.2.M32.Z	1-1106434-4	97
HD.7.SKB	0-1108741-3	--	HD-K.40.SG-LB.1.21.Z	2-1102575-2	121	HD-Z.24.STS-ZB.1.21.G	1-1102496-3	96
HD.7.Sti.C.B1-7	2-1103002-3	48	HD-K.40.SG-LB.2.M32.Z	0-1106451-7	121	HD-Z.24.STS-ZB.1.29.G	1-1102499-3	96
HD.7.Sti.C/250V	2-1103000-3	48	HD-K.40.SG-VS.1.21.Z	2-1102575-1	116	HD-Z.24.STS-ZB.1.M32.G	1-1106434-3	96
HD.7.STO.1.11.Z	1-1102416-7	--	HD-K.40.SG-VS.1.29.Z	2-1102579-1	116	HD-Z.40.SG-ZVGR.2.M32.Z	1-1106451-0	124
HD.7.STO.1.M20.Z	0-1102856-1	--	HD-K.40.SG-VS.2.21.Z	2-1102577-1	116	HD-Z.40.STS-ZB.1.21.G	1-1102564-3	123
HD.7.STW.1.11.Z	1-1102418-7	--	HD-K.40.SG-VS.2.M32.Z	0-1106451-8	116	HD-Z.40.STS-ZB.1.29.G	1-1102567-3	123
HD.7.STW.1.M20.Z	0-1102858-1	--	HD-K.40.STO.1.21.G	2-1102570-6	116	HD-Z.40.STS-ZB.1.M32.G	1-1106452-6	123
HD.8.Bu.C	0-1102893-1	48	HD-K.40.STO.1.29.G	2-1102573-6	116	HD-Z.64.SG-ZVGR.1.21.Z	1-1103346-8	149
HD.8.Sti.C	0-1102892-1	48	HD-K.40.STO.1.M32.G	0-1106452-7	116	HD-Z.64.SG-ZVGR.1.29.Z	1-1103350-8	149
HD.M-C-Bu.Au.0,3-0,56 mm ² A	1-163087-1	35	HD-K.40.STO-GR.1.21.G	2-1102570-7	120	HD-Z.64.SG-ZVGR.2.29.Z	1-1103352-8	149
HD.M-C-Bu.Au.0,8-1,5 mm ² A	0-0163083-7	35	HD-K.40.STO-GR.1.M32.G	0-1106452-8	120	HD-Z.64.SG-ZVGR.2.M32.Z	1-1106469-2	149
HD.M-C-Bu.Sn.0,3-0,56 mm ²	1-1105001-3	35	HD-K.40.STO-VS.1.21.G	2-1102570-1	118	HD-Z.64.STS-ZB.1.21.G	1-1103336-3	148
HD.M-C-Bu.Sn.0,5-1,5 mm ²	2-1105001-3	35	HD-K.40.STO-VS.1.M32.G	0-1106452-9	118	HD-Z.64.STS-ZB.1.29.G	1-1103338-3	148
HD.M-C-Bu.Sn.1,5-2,5 mm ²	4-1105001-3	35	HD-K.40.STS.1.21.G	2-1102564-6	115	HD-Z.64.STS-ZB.1.M32.G	1-1106470-8	148
HD.M-C-Sti.Au.0,3-0,56 mm ²	1-1105000-2	35	HD-K.40.STS.1.29.G	2-1102567-6	115	HE.10.Bu.C	2-1103637-3	81
HD.M-C-Sti.Au.0,3-0,56 mm ² A	0-0164160-4	35	HD-K.40.STS.1.M32.G	1-1106450-0	115	HE.10.Bu.S	1-1103637-1	81
HD.M-C-Sti.Au.0,8-1,5 mm ²	3-1105000-2	35	HD-K.40.STS-GR.1.21.G	2-1102564-7	120	HE.10.Bu.SC	7-1103637-1	81
HD.M-C-Sti.Au.0,8-1,5 mm ² A	0-0164161-4	35	HD-K.40.STS-GR.1.29.G	2-1102567-7	120	HE.10.Sti.C	2-1103636-3	81
HD.M-C-Sti.Au.1,5-2,5 mm ²	1-1105000-3	35	HD-K.40.STS-GR.1.M32.G	1-1106452-1	120	HE.10.Sti.S	1-1103636-1	81
HD.M-C-Sti.Sn.0,5-1,5 mm ²	2-1105000-3	35	HD-K.40.STS-VS.1.21.G	2-1102564-1	118	HE.10.Sti.SC	7-1103636-1	81
HD.M-C-Sti.Sn.0,5-1,5 mm ² A	0-0164161-9	35	HD-K.40.STS-VS.1.29.G	2-1102567-1	118	HE.16.Bu.C.B1-16	2-1103639-3	106
HD.M-C-Sti.Sn.1,5-2,5 mm ²	4-1105000-3	35	HD-K.40.STS-VS.1.M32.G	1-1106452-2	118	HE.16.Bu.C.B1-16	2-1103639-3	155
HD.M-C-Sti.Sn.1,5-2,5 mm ² B	0-0166824-2	35	HD-K.64.SGD.1.29.Z	2-1103364-6	143	HE.16.Bu.C.B17-32	2-1103639-9	155
HD20 R.F.HANDTOOL	169424-1	32	HD-K.64.SGD.2.M32.Z	0-1106469-5	143	HE.16.Bu.S.B1-16	1-1103639-1	106
HD-K.108.STO.1.36.G	2-1102414-6	140	HD-K.64.SGD-LB.1.29.Z	2-1103364-2	146	HE.16.Bu.S.B1-16	1-1103639-1	155
HD-K.108.STO.1.M50.G	0-1106467-7	140	HD-K.64.SGD-LB.2.M32.Z	0-1106469-6	146	HE.16.Bu.S.B17-32	1-1103639-9	155
HD-K.108.STS.1.29.G	2-1102411-6	139	HD-K.64.SG-LB.1.29.Z	2-1103350-2	146	HE.16.Bu.SC.B1-16	7-1103639-1	106
HD-K.108.STS.1.M50.G	1-1106467-0	139	HD-K.64.SG-LB.2.M32.Z	0-1106469-7	146	HE.16.Bu.SC.B1-16	7-1103639-1	155
HD-K.108.STS-GR.1.29.G	2-1102411-7	144	HD-K.64.SG-VS.1.21.Z	2-1103346-1	141	HE.16.Bu.SC.B17-32	7-1103639-9	155
HD-K.108.STS-GR.1.M50.G	1-1106467-1	144	HD-K.64.SG-VS.1.29.Z	2-1103350-1	141	HE.16.Sti.C.B1-16	2-1103638-3	106
HD-K.16.KDO-LB.1.21.G	2-1102489-2	76	HD-K.64.SG-VS.2.21.Z	2-1103348-1	141	HE.16.Sti.C.B1-16	2-1103638-3	155
HD-K.16.KDO-LB.1.M32.G	0-1106421-2	76	HD-K.64.SG-VS.2.29.Z	2-1103352-1	141	HE.16.Sti.C.B17-32	2-1103638-9	155
HD-K.16.SGD-LB.1.21.Z	2-1102480-2	75	HD-K.64.SG-VS.2.M32.Z	0-1106469-8	141	HE.16.Sti.S.B1-16	1-1103638-1	106
HD-K.16.SGD-LB.2.21.Z	2-1102482-2	75	HD-K.64.STO.1.21.G	2-1103341-6	140	HE.16.Sti.S.B1-16	1-1103638-1	155
HD-K.16.SGD-LB.2.M32.Z	0-1106422-3	75	HD-K.64.STO.1.29.G	2-1103344-6	140	HE.16.Sti.S.B17-32	1-1103638-9	155
HD-K.16.SG-LB.1.21.Z	2-1102472-2	75	HD-K.64.STO.1.M32.G	0-1106470-7	140	HE.16.Sti.SC.B1-16	7-1103638-1	106
HD-K.16.SG-LB.2.21.Z	2-1102474-2	75	HD-K.64.STO-GR.1.29.G	2-1103344-7	145	HE.16.Sti.SC.B1-16	7-1103638-1	155
HD-K.16.SG-LB.2.M32.Z	0-1106422-4	75	HD-K.64.STO-GR.1.M32.G	0-1106470-8	145	HE.16.Sti.SC.B17-32	7-1103638-9	155
HD-K.16.STO.1.21.G	2-1102467-7	74	HD-K.64.STO-VS.1.29.G	2-1103344-1	142	HE.24.Bu.C.B1-24	2-1103641-3	132
HD-K.16.STO.1.M32.G	0-1106423-3	74	HD-K.64.STO-VS.1.M32.G	0-1106470-9	142	HE.24.Bu.C.B1-24	2-1103641-3	168
HD-K.16.STS.1.21.G	2-1102461-7	73	HD-K.64.STS.1.21.G	2-1103336-6	139	HE.24.Bu.C.B25-48	2-1103641-9	168
HD-K.16.STS.1.M32.G	0-1106423-4	73	HD-K.64.STS.1.29.G	2-1103338-6	139	HE.24.Bu.S.B1-24	1-1103641-1	132
HD-K.24.KDO-LB.1.29.G	2-1102519-2	94	HD-K.64.STS.1.M32.G	1-1106470-0	139	HE.24.Bu.S.B1-24	1-1103641-1	168
HD-K.24.KDO-LB.1.M32.G	0-1106432-3	94	HD-K.64.STS-GR.1.29.G	2-1103338-7	144	HE.24.Bu.S.B25-48	1-1103641-9	168
HD-K.24.KDO-VS.1.M32.G	0-1106432-4	89	HD-K.64.STS-GR.1.M32.G	1-1106470-1	144	HE.24.Bu.S.B1-24	1-1103641-1	132
HD-K.24.SGD.2.29.Z	2-1102527-6	91	HD-K.64.STS-VS.1.29.G	2-1103338-1	142	HE.24.Bu.SC.B1-24	7-1103641-1	168
HD-K.24.SGD.2.M32.Z	0-1106433-5	91	HD-K.64.STS-VS.1.M32.G	1-1106470-2	142	HE.24.Bu.SC.B25-48	7-1103641-9	168
HD-K.24.SGD-LB.1.21.Z	2-1102521-2	94	HD-K/Z.16.SG-ZVGR.1.21.Z	2-1102472-8	78	HE.24.Sti.C.B1-24	2-1103640-3	132
HD-K.24.SGD-LB.1.29.Z	2-1102525-2	94	HD-K/Z.16.SG-ZVGR.2.21.Z	2-1102474-8	78	HE.24.Sti.C.B1-24	2-1103640-3	168
HD-K.24.SGD-LB.2.29.Z	2-1102527-2	94	HD-K/Z.16.SG-ZVGR.2.M32.Z	1-1106469-1	78	HE.24.Sti.C.B25-48	2-1103640-9	168
HD-K.24.SGD-LB.2.M32.Z	0-1106433-6	94	HD-K/Z.16.STS-ZB.1.21.G	2-1102461-3	77	HE.24.Sti.S.B1-24	1-1103640-1	132
HD-K.24.SG-LB.2.M32.Z	0-1106433-7	93	HD-K/Z.24.SG-ZVGR.1.29.Z	2-1102511-8	97	HE.24.Sti.S.B1-24	1-1103640-1	168

Sortiert nach Bezeichnung/Sorted by description

Bestelltext	Best-Nr.	Seite	Bestelltext	Best-Nr.	Seite	Bestelltext	Best-Nr.	Seite
HE.24.Sti.S.B25-48	1-1103640-9	168	HF-EMVK.12.STO.2.M50.G+1.M20.G	0-1102840-3	176	HIP.16/40.SG.2.M32.G	0-1106453-1	126
HE.24.Sti.SC.B1-24	7-1103640-1	132	HF-EMV-K.8.AG	0-1102836-1	176	HIP.16/40.STO.1.21.G	1-1102653-5	125
HE.24.Sti.SC.B1-24	7-1103640-1	168	HF-EMV-K.8.AG.N	0-1102837-1	176	HIP.16/40.STO.1.29.G	1-1102655-5	125
HE.24.Sti.SC.B25-48	7-1103640-9	168	HF-EMV-K.8.STO.1.M50.G	0-1102839-3	176	HIP.16/40.STO.1.M32.G	0-1106454-1	125
HE.6.Bu.C.B1-6	2-1103635-3	66	HF-EMV-K.8.STO.2.M40.G	0-1102839-1	176	HIP.16/40.STS.1.21.G	1-1102649-5	125
HE.6.Bu.S.B1-6	1-1103635-1	66	HF-HIPK.12.AG	0-1102192-2	176	HIP.16/40.STS.1.29.G	1-1102651-5	125
HE.6.Bu.SC.B1-6	7-1103635-1	66	HF-HIP-K.12.AG.N	0-1102838-2	176	HIP.16/40.STS.1.M32.G	0-1106454-2	125
HE.6.Sti.C.B1-6	2-1103634-3	66	HF-HIPK.12.STO.2.M40.G+1.M20.G	0-1102840-2	176	HIP.24/64.AG	1-1102665-5	151
HE.6.Sti.S.B1-6	1-1103634-1	66	HF-HIP-K.8.STO.2.M50.G+1.M20.G	0-1102840-4	176	HIP.24/64.AG.M6	1-1102626-5	151
HE.6.Sti.SC.B1-6	7-1103634-1	66	HF-HIP-K.8.AG	0-1102836-2	176	HIP.24/64.SG.1.29.G	1-1102624-5	151
HE/HA-C-Bu.Ag.0,14-0,37mm²	6-1105101-1	37	HF-HIP-K.8.AG.N	0-1102837-2	176	HIP.24/64.SG.2.29.G	1-1102625-5	151
HE/HA-C-Bu.Ag.0,5 mm²	1-1105101-1	37	HF-HIP-K.8.STO.1.M50.G	0-1102839-4	176	HIP.24/64.SG.2.M40.G	0-1106472-1	151
HE/HA-C-Bu.Ag.0,75-1,0 mm²	2-1105101-1	37	HG-Q.10.Bu.C	0-1103091-1	55	HIP.24/64.STO.1.21.G	1-1102662-5	150
HE/HA-C-Bu.Ag.1,5 mm²	3-1105101-1	37	HG-Q.10.MC.1	0-1103092-1	58	HIP.24/64.STO.1.29.G	1-1102664-5	150
HE/HA-C-Bu.Ag.2,5 mm²	4-1105101-1	37	HG-Q.10.MC.2	0-1103092-2	58	HIP.24/64.STO.1.M40.G	0-1106473-1	150
HE/HA-C-Bu.Ag.4,0 mm²	5-1105101-1	37	HG-Q.10.MC.3	0-1103092-3	58	HIP.24/64.STS.1.21.G	1-1102658-5	150
HE/HA-C-Bu.Au.0,5 mm²	1-1105101-2	37	HG-Q.10.MC.4	0-1103092-4	58	HIP.24/64.STS.1.29.G	1-1102660-5	150
HE/HA-C-Bu.Au.0,75-1,0 mm²	2-1105101-2	37	HG-Q.10.MC.5	0-1103092-5	58	HIP.24/64.STS.1.M40.G	0-1106473-2	150
HE/HA-C-Bu.Au.1,5 mm²	3-1105101-2	37	HG-Q.10.MC.6	0-1103092-6	58	HIP.3/4.AG	1-1102603-5	53
HE/HA-C-Bu.Au.2,5 mm²	4-1105101-2	37	HG-Q.10.MC.7	0-1103092-7	58	HIP.3/4.SG.1.11.G	1-1102601-5	54
HE/HA-C-Bu.Au.4,0 mm²	5-1105101-2	37	HG-Q.10.Sti.C	0-1108808-1	55	HIP.3/4.SG.1.M16.G	0-1106407-1	54
HE/HA-C-Sti.Ag.0,14-0,37mm²	6-1105100-1	37	HG-Q.10-EMV.MC.1	0-1103092-8	58	HIP.3/4.SGF	1-1102602-5	53
HE/HA-C-Sti.Ag.0,5 mm²	1-1105100-1	37	HG-Q.10-EMV.MC.2	0-1103092-9	58	HIP.3/4.STO.1.11.G	1-1102600-5	53
HE/HA-C-Sti.Ag.0,75-1,0 mm²	2-1105100-1	37	HG-Q.10-EMV.MC.3	1-1103092-0	58	HIP.3/4.STO.1.M16.G	0-1106408-1	53
HE/HA-C-Sti.Ag.1,5 mm²	3-1105100-1	37	HG-Q.10-EMV.MC.4	1-1103092-1	58	HIP.6/16.AG	1-1102638-5	79
HE/HA-C-Sti.Ag.2,5 mm²	4-1105100-1	37	HG-Q.10-EMV.MC.5	1-1103092-2	58	HIP.6/16.AG.M6	1-1102606-5	79
HE/HA-C-Sti.Ag.4,0 mm²	5-1105100-1	37	HG-Q.10-EMV.MC.6	1-1103092-3	58	HIP.6/16.SG.1.16.G	1-1102604-5	80
HE/HA-C-Sti.Au.0,5 mm²	1-1105100-2	37	HG-Q.10-EMV.MC.7	1-1103092-4	58	HIP.6/16.SG.2.16.G	1-1102605-5	80
HE/HA-C-Sti.Au.0,75-1,0 mm²	2-1105100-2	37	HG-Q.4/2.Bu.C	0-1103096-1	55	HIP.6/16.SG.2.M32.G	0-1106424-1	80
HE/HA-C-Sti.Au.1,5 mm²	3-1105100-2	37	HG-Q.4/2.Sti.C	0-1103095-1	55	HIP.6/16.STO.1.16.G	1-1102635-5	79
HE/HA-C-Sti.Au.2,5 mm²	4-1105100-2	37	HG-Q.5.AG	0-1103171-1	51	HIP.6/16.STO.1.M32.G	0-1106425-1	79
HE/HA-C-Sti.Au.4,0 mm²	5-1105100-2	37	HG-Q.5.AG.BL	0-1103171-2	51	HIP.6/16.STS.1.16.G	1-1102631-5	79
HEE.10.Bu.C.B1-10	0-1102919-1	67	HG-Q.5.AGW	0-1103172-1	52	HIP.6/16.STS.1.M25.G	0-1106425-2	79
HEE.10.Bu.C.B1-10-FS	0-1102919-2	67	HG-Q.5.AGW.BL	0-1103172-2	52	HIP/EMV.10/24.SKB	3-1106202-5	99
HEE.10.Sti.C.B1-10	0-1102918-1	67	HG-Q.5.DE	0-1103176-1	184	HIP/EMV.10/24.SKB	3-1106202-5	185
HEE.10.Sti.C.B1-10-FS	0-1102918-2	67	HG-Q.5.DE.BL	0-1103176-2	184	HIP/EMV.16/40.SKB	3-1106203-5	126
HEE.18.Bu.C.B1-18	0-1102898-1	82	HG-Q.5.KDO.1.M25	0-1103174-1	52	HIP/EMV.16/40.SKB	3-1106205-5	185
HEE.18.Bu.C.B1-18-FS	0-1102898-2	82	HG-Q.5.KDO.1.M25.BL	0-1103174-2	52	HIP/EMV.24/64.SKB	3-1106204-5	151
HEE.18.Sti.C.B1-18	0-1102897-1	82	HG-Q.5.SG.1.M25	0-1103173-1	52	HIP/EMV.24/64.SKB	3-1106204-5	185
HEE.18.Sti.C-FS	0-1102897-2	82	HG-Q.5.SG.1.M25.BL	0-1103173-2	52	HIP/EMV.3/4.SKB	3-1106200-5	54
HEE.32.Bu.C.B1-32	0-1102896-1	107	HG-Q.5.STO.1.M25	0-1103169-1	51	HIP/EMV.6/16.SKB	3-1106201-5	80
HEE.32.Bu.C-FS	0-1102896-3	107	HG-Q.5.STO.1.M25.BL	0-1103169-2	51	HIP/EMV.6/16.SKB	3-1106201-5	185
HEE.32.Sti.C.B1-32	0-1102895-1	107	HG-Q.5.STW.1.M25	0-1103170-1	51	HIP-K.10/24.AG	2-1102647-5	98
HEE.32.Sti.C.B1-32-FS	0-1102895-3	107	HG-Q.5.STW.1.M25.BL	0-1103170-2	51	HIP-K.10/24.AG.M6	2-1102612-5	99
HEE.46.Bu.C.B1-46	0-1102887-1	133	HG-Q.8.Bu.C	0-1103071-1	55	HIP-K.10/24.SG.1.21.G	5-1102610-5	99
HEE.46.Bu.C.B1-46-FS	0-1102887-1	170	HG-Q.8.Sti.C	0-1103070-1	55	HIP-K.10/24.SG.2.21.G	2-1102611-5	99
HEE.46.Bu.C.B1-46-FS	0-1102887-4	133	HG-Q.AG-LB	0-1103072-1	57	HIP-K.10/24.STO.1.16.G	2-1102644-5	98
HEE.46.Bu.C.B47-92	0-1102887-2	170	HG-Q.Flanschdicht-L	0-1108794-2	59	HIP-K.10/24.STO.1.M25.G	0-1106436-3	98
HEE.46.Sti.C.B1-46	0-1102886-1	133	HG-Q.KDO-LB.1.M25.Z	0-1108795-1	57	HIP-K.10/24.STO.1.M32.G	0-1106436-5	98
HEE.46.Sti.C.B1-46-FS	0-1102886-1	170	HG-Q.KDS-LB.1.M25.Z	0-1108795-2	57	HIP-K.10/24.STS.1.21.G	2-1102642-5	98
HEE.46.Sti.C.B1-46-FS	0-1102886-4	133	HG-Q.M25.10,5/7,0	0-1103074-4	59	HIP-K.10/24.STS.1.M25.G	0-1106436-4	98
HEE.46.Sti.C.B47-92	0-1102886-2	170	HG-Q.M25.13,0/9,0	0-1103074-5	59	HIP-K.10/24.STS.1.M32.G	0-1106436-6	98
HE-K.4/8.Bu.S	0-1102677-1	137	HG-Q.M25.15,5/11,5	0-1103074-6	59	HIP-K.16/40.AG	2-1102656-5	125
HE-K.4/8.Sti.S	0-1102077-1	137	HG-Q.M25.6,5/4,0	0-1103074-1	59	HIP-K.16/40.AG.M6	2-1102618-5	125
HE-Q.5.Bu.C	0-1102194-1	46	HG-Q.M25.8,0/5,0	0-1103074-2	59	HIP-K.16/40.SG.1.21.G	5-1102616-5	126
HE-Q.5.Sti.C	0-1102195-1	46	HG-Q.M25.9,5/6,5	0-1103074-3	59	HIP-K.16/40.SG.2.21.G	2-1102617-5	126
HF.06.Bu	0-1110949-1	42	HG-Q.STO.1.M25.Z	0-1103073-2	56	HIP-K.16/40.SG.2.M32.G	0-1106443-1	126
HF.06.Sti	0-1110948-1	42	HG-Q.STS.1.M25.Z	0-1103073-1	56	HIP-K.16/40.STO.1.29.G	2-1102655-5	125
HF.06-CH-06 mm²-SW17	0-1110952-1	42	HG-Q.STS.2.M25.Z	0-1103155-1	56	HIP-K.16/40.STO.1.M32.G	0-1106444-1	125
HF.06-CH-10 mm²-SW17	0-1110952-2	42	HG-Q-EMV.AG-LB	0-1103072-2	57	HIP-K.16/40.STO.2.21.G	0-1108534-1	125
HF.06-CH-16 mm²-SW17	0-1110952-3	42	HG-Q-EMV.KDO-LB.1.M25.Z	0-1108795-3	57	HIP-K.16/40.STS.1.29.G	2-1102651-5	125
HF.06-CH-25 mm²-SW17	0-1110952-5	42	HG-Q-EMV.KDS-LB.1.M25.Z	0-1108795-4	57	HIP-K.16/40.STS.1.M32.G	0-1106444-2	125
HF.06-CH-35 mm²-SW17	0-1110952-7	42	HG-Q-EMV.KDS-LB.1.M25.Z	0-1108795-4	59	HIP-K.24/64.AG	2-1102665-5	151
HF.06-CH-50 mm²-SW17	0-1110952-9	42	HG-Q-EMV.STO.1.M25.Z	0-1103073-4	56	HIP-K.24/64.AG.M6	2-1102626-5	151
HF.06-CH-70 mm²-SW17	1-1110952-0	42	HG-Q-EMV.STS.1.M25.Z	0-1103073-3	56	HIP-K.24/64.AG.M6.D	2-1102628-5	151
HF.12.3+PE+Bg2/0	0-1110955-3	175	HG-Q-EMV.STS.2.M25.Z	0-1103155-2	56	HIP-K.24/64.SG.1.29.G	5-1102624-5	151
HF.12.3+PE+Bg2/U	0-1110955-1	175	HIP.10/24.AG	1-1102647-5	98	HIP-K.24/64.SG.2.29.G	2-1102625-5	151
HF.12.3+PE+Bg3/0	0-1110955-4	175	HIP.10/24.AG.M6	1-1102612-5	99	HIP-K.24/64.SG.2.M40.G	0-1106472-2	151
HF.12.3+PE+Bg3/U	0-1110955-2	175	HIP.10/24.SG.1.21.G	1-1102610-5	99	HIP-K.24/64.STO.1.29.G	2-1102664-5	150
HF.13-CH-105 mm²-SW27	0-1110953-8	42	HIP.10/24.SG.2.21.G	1-1102611-5	99	HIP-K.24/64.STO.1.M40.G	0-1102647-3	150
HF.13-CH-120 mm²-SW27	0-1110953-9	42	HIP.10/24.SG.2.M32.G	0-1106435-1	99	HIP-K.24/64.STO.2.M32.G	0-1102792-1	150
HF.13-CH-150 mm²-SW27	1-1110953-1	42	HIP.10/24.STO.1.16.G	1-1102644-5	98	HIP-K.24/64.STS.1.29.G	2-1102660-5	150
HF.13-CH-50 mm²-SW19	0-1110953-5	42	HIP.10/24.STO.1.21.G	1-1102646-5	98	HIP-K.24/64.STS.1.M40.G	0-1106473-4	150
HF.13-CH-70 mm²-SW19	0-1110953-6	42	HIP.10/24.STO.1.M32.G	0-1102643-1	98	HIP-K.3/4.AG	1-1102603-5	53
HF.13-CH-95 mm²-SW27	0-1110953-7	42	HIP.10/24.STS.1.16.G	1-1102640-5	98	HIP-K.3/4.SG.1.11.G	2-1102601-5	54
HF.8-2+1xBg1/0	0-1110960-2	175	HIP.10/24.STS.1.21.G	1-1102642-5	98	HIP-K.3/4.SG.1.M16.G	0-1106407-2	54
HF.8-2+1xBg1/U	0-1110960-1	175	HIP.10/24.STS.1.M25.G	0-1106436-2	98	HIP-K.3/4.SGF	2-1102602-5	53
HF.8-2+1xBg1/U-2	0-1110960-3	175	HIP.16/40.AG	1-1102656-5	125	HIP-K.3/4.STO.1.11.G	2-1102600-5	53
HF-EMVK.12.AG	0-1102192-1	176	HIP.16/40.AG.M6	1-1102618-5	125	HIP-K.3/4.STO.1.M16.G	0-1106408-2	53
HF-EMV-K.12.AG.N	0-1102838-1	176	HIP.16/40.SG.1.21.G	1-1102616-5	126	HIP-K.3/4.STO.1.M20.G	0-1106408-3	53
HF-EMVK.12.STO.2.M40.G+1.M20.G	0-1102840-1	176	HIP.16/40.SG.2.21.G	1-1102617-5	126	HIP-K.6/16.AG	2-1102638-5	79

Sortiert nach Bezeichnung/Sorted by description

Bestelltext	Best-Nr.	Seite	Bestelltext	Best-Nr.	Seite	Bestelltext	Best-Nr.	Seite
HIP-K.6/16.AG.M6	2-1102606-5	79	HN.D-C-Bu.Au.0,14-0,37	1-1105051-2	34	HUT.M40.P	4-1102771-0	190
HIP-K.6/16.SG.1.16.A	2-1102604-5	80	HN.D-C-Bu.Au.0,5	2-1105051-2	34	HUT.M50.MS	5-1102770-0	190
HIP-K.6/16.SG.2.16.G	2-1102605-5	80	HN.D-C-Bu.Au.0,75-1,0	3-1105051-2	34	HUT.M50.P	5-1102771-0	190
HIP-K.6/16.SG.2.M32.G	0-1106424-2	80	HN.D-C-Bu.Au.1,5	4-1105051-2	34	HVS-AIR.2.Bu	0-1103247-1	210
HIP-K.6/16.STO.1.16.G	2-1102635-5	79	HN.D-C-Bu.Au.2,5	5-1105051-2	34	HVS-AIR.2.Sti	0-1103246-1	210
HIP-K.6/16.STO.1.21.G	2-1102637-5	79	HN.D-C-Sti.Ag.0,14-0,37	1-1105050-1	34	HVS-BLD	0-1103266-1	211
HIP-K.6/16.STO.1.M25.G	0-1106425-6	79	HN.D-C-Sti.Au.0,5	2-1105050-2	34	HVS-HE.20.Bu.C	0-1103145-1	207
HIP-K.6/16.STO.1.M32.G	0-1106425-3	79	HN.D-C-Sti.Au.0,75-1,0	3-1105050-2	34	HVS-HE.20.Sti.C	0-1103144-1	207
HIP-K.6/16.STS.1.16.G	2-1102631-5	79	HN.D-C-Sti.Au.1,5	4-1105050-2	34	HVS-HE.5.Bu.SC	0-1103134-1	205
HIP-K.6/16.STS.1.21.G	2-1102633-5	79	HN.D-C-Sti.Au.2,5	5-1105050-2	34	HVS-HE.5.Sti.SC	0-1103133-1	205
HIP-K.6/16.STS.1.M25.G	0-1106425-4	79	HSB.6/35.Bu.S.B1-6	1-1104205-1	113	HVS-HE.6.Bu.C	0-1103245-1	206
HIP-K/EMV-K.10/24.SKB	4-1106202-5	99	HSB.6/35.Bu.S.B1-6	1-1104205-1	156	HVS-HE.6.Sti.C	0-1103244-1	206
HIP-K/EMV-K.10/24.SKB	4-1106202-5	185	HSB.6/35.Bu.S.B7-12	1-1104207-1	156	HVS-HE.8.Bu.C	0-1103141-1	206
HIP-K/EMV-K.16/40.SKB	4-1106203-5	126	HSB.6/35.Sti.S.B1-6	1-1104204-1	113	HVS-HE.8.Sti.C	0-1103140-1	206
HIP-K/EMV-K.16/40.SKB	4-1106203-5	185	HSB.6/35.Sti.S.B1-6	1-1104204-1	156	HVS-HND.12.Bu.C	0-1103276-1	207
HIP-K/EMV-K.24/64.SKB	4-1106204-5	151	HSB.6/35.Sti.S.B7-12	1-1104206-1	156	HVS-HND.12.Sti.C	0-1103277-1	207
HIP-K/EMV-K.24/64.SKB	4-1106204-5	185	HSK.6+36.Bu.C	0-1108762-1	111	HVS-HND.17.Bu.C	0-1103279-1	208
HIP-K/EMV-K.3/4.SKB	4-1106200-5	54	HSK.6+36.Sti.C	0-1108761-1	111	HVS-HND.17.Sti.C	0-1103278-1	208
HIP-K/EMV-K.6/16.SKB	4-1106201-5	80	HSK.Bu.C.1,5 mm ²	1-1108756-1	39	HVS-HSK.2.Bu.C	0-1103271-1	204
HIP-K/EMV-K.6/16.SKB	4-1106201-5	185	HSK.Bu.C.10,0 mm ²	5-1108756-1	39	HVS-HSK.2.Sti.C	0-1103270-1	204
HIP-KF.24/64.STS.1.29.G	1-1102622-5	150	HSK.Bu.C.2,5 mm ²	2-1108756-1	39	HVS-HSK.3.Bu.C	0-1103273-1	205
HIP-KF.24/64.STS.1.36.G	1-1102623-5	150	HSK.Bu.C.4,0 mm ²	3-1108756-1	39	HVS-HSK.3.Sti.C	0-1103272-1	205
HIP-KF.24/64.STS.1.M40.G	0-1106474-1	150	HSK.Bu.C.6,0 mm ²	4-1108756-1	39	HVS-HSS.2.Bu.C	0-1103274-1	204
HIP-KF.K.24/64.STS.1.29.G	2-1102622-5	150	HSK.RSZ.LC 0,75-2,5 mm ²	0-1102789-1	39	HVS-HSS.2.Sti.C	0-1103275-1	204
HIP-KF.K.24/64.STS.1.36.G	2-1102623-5	150	HSK.RSZ.LC 4-10 mm ²	0-1102790-1	39	HVS-MM.17.Bu.C	0-1103281-1	208
HIP-KF.K.24/64.STS.1.M40.G	0-1106474-2	150	HSK.Sti.C 1,5 mm ²	1-1108757-1	39	HVS-MM.17.Sti.C	0-1103280-1	208
HIP-K-I.24/64.AG.M6.D	0-1108533-1	151	HSK.Sti.C 10 mm ²	5-1108757-1	39	HVS-MVB.HND.4.Sti.C	0-1103251-1	210
HM.10-82/82	8-1108772-2	95	HSK.Sti.C 2,5 mm ²	2-1108757-1	39	HVS-MVB.S20DF.8.Sti.C	0-1103258-1	210
HM.10-85/85	8-1108772-5	95	HSK.Sti.C 4,0 mm ²	3-1108757-1	39	HVS-R.0.1-2	0-1103250-7	72
HM.10-90/90	8-1108772-0	95	HSK.Sti.C 6,0 mm ²	4-1108757-1	39	HVS-R.0.1-2	0-1103250-7	201
HM.10-94/94	8-1108772-4	95	HSM.Bu.C.AG.0,75 mm ²	1-1105251-1	40	HVS-R.0.1-2	0-1103250-7	211
HM.10-98/98	8-1108772-8	95	HSM.Bu.C.AG.1,5 mm ²	2-1105251-1	40	HVS-R.0.1-3	0-1103250-5	86
HMX.4/0.Bu.S	0-1104700-1	113	HSM.Bu.C.AG.10 mm ²	6-1105251-1	40	HVS-R.0.1-3	0-1103250-5	211
HMX.4/0.Sti.S	0-1104701-1	113	HSM.Bu.C.AG.2,5 mm ²	3-1105251-1	40	HVS-R.0.1-4	0-1103250-3	114
HMX.4/2.Bu.S	0-1102076-1	113	HSM.Bu.C.AG.4 mm ²	4-1105251-1	40	HVS-R.0.1-4	0-1103250-3	212
HMX.4/2.Sti.S	0-1102075-1	113	HSM.Bu.C.AG.6 mm ²	5-1105251-1	40	HVS-R.0.1-6	0-1103250-1	138
HN.2D.108.Bu.C.B109-216	2-1103221-3	169	HSM.Sti.C.AG.0,75 mm ²	1-1105250-1	40	HVS-R.0.1-6	0-1103250-1	212
HN.2D.108.Bu.C.B1-108	2-1103220-3	135	HSM.Sti.C.AG.1,5 mm ²	2-1105250-1	40	HVS-R.U.1-2	0-1103250-8	159
HN.2D.108.Bu.C.B1-108	2-1103220-3	169	HSM.Sti.C.AG.10 mm ²	6-1105250-1	40	HVS-R.U.1-2	0-1103250-8	201
HN.2D.108.Sti.C.B109-216	2-1103217-3	169	HSM.Sti.C.AG.2,5 mm ²	3-1105250-1	40	HVS-R.U.1-2	0-1103250-8	211
HN.2D.108.Sti.C.B1-108	2-1103216-3	135	HSM.Sti.C.AG.4 mm ²	4-1105250-1	40	HVS-R.U.1-3	0-1103250-6	159
HN.2D.108.Sti.C.B1-108	2-1103216-3	169	HSM.Sti.C.AG.6 mm ²	5-1105250-1	40	HVS-R.U.1-3	0-1103250-6	211
HN.2D.24.Bu.C	2-1103202-3	70	HSS.8/2.Bu.C	2-1104202-3	137	HVS-R.U.1-4	0-1103250-4	171
HN.2D.24.Sti.C	2-1103200-3	70	HSS.8/2.Sti.C	2-1104200-3	137	HVS-R.U.1-4	0-1103250-4	212
HN.2D.42.Bu.C	2-1103206-3	85	HSS-C-Bu.AG.10 mm ²	4-1105151-1	41	HVS-R.U.1-6	0-1103250-2	171
HN.2D.42.Sti.C	2-1103204-3	85	HSS-C-Bu.AG.16 mm ²	5-1105151-1	41	HVS-R.U.1-6	0-1103250-2	212
HN.2D.72.Bu.C.B1-72	2-1103212-3	109	HSS-C-Bu.AG.6 mm ²	3-1105151-1	41	HVS-S20DF.25.Bu.C	0-1103261-1	209
HN.2D.72.Bu.C.B1-72	2-1103212-3	157	HSS-C-Bu.AU.6 mm ²	3-1105151-2	41	HVS-S20DF.25.Sti.C	0-1103260-1	209
HN.2D.72.Bu.C.B73-144	2-1103213-3	157	HSS-C-Bu.AU.10 mm ²	4-1105151-2	41	HVS-TX.2.Bu	0-1103269-1	209
HN.2D.72.Sti.C.B1-72	2-1103208-3	109	HSS-C-Bu.AU.16 mm ²	5-1105151-2	41	HVS-TX.2.Sti	0-1103267-1	209
HN.2D.72.Sti.C.B1-72	2-1103208-3	157	HSS-C-Sti.AG.10 mm ²	4-1105150-1	41	HVS-TX.HN.D.4.Bu.C	0-1103286-1	209
HN.2D.72.Sti.C.B73-144	2-1103209-3	157	HSS-C-Sti.AG.16 mm ²	5-1105150-1	41	HVS-TX.HN.D.4.Sti.C	0-1103283-1	209
HN.D.15.Bu.C	2-1103107-3	61	HSS-C-Sti.AG.6 mm ²	3-1105150-1	41	HVS-TX.S20DF.8.Bu.C	0-1103297-1	209
HN.D.15.Sti.C B1-15	2-1103106-3	61	HSS-C-Sti.AU.10 mm ²	4-1105150-2	41	HVS-TX.S20DF.8.Sti.C	0-1103291-1	209
HN.D.25.Bu.C	2-1103109-3	101	HSS-C-Sti.AU.16 mm ²	5-1105150-2	41	HVT.14.Bu.C	2-1104006-3	83
HN.D.25.Bu.C	2-1103109-3	128	HSS-C-Sti.AU.6 mm ²	3-1105150-2	41	HVT.14.Sti.C	2-1104004-3	83
HN.D.25.Bu.C B1-25/Z	0-1103109-1	101	HSS-CSZ.2,5-70 mm ²	1-1105653-8	41	HVT.23.Bu.C	2-1104010-3	108
HN.D.25.Bu.C B1-25/Z	0-1103109-1	128	HSS-CSZ.2,5-70 mm ²	1-1105653-8	42	HVT.23.Sti.C	2-1104008-3	108
HN.D.25.Sti.C B1-25	2-1103108-3	101	HUT.11.MS	1-1106006-9	190	HVT.35.Bu.C	2-1104014-3	134
HN.D.25.Sti.C B1-25	2-1103108-3	128	HUT.11.P-GRAU	1-1106005-7	190	HVT.35.Sti.C	2-1104012-3	134
HN.D.25.Sti.C B1-25/Z	0-1103108-1	101	HUT.13.MS	2-1106006-9	190	HVT.48.Bu.C	2-1104018-3	134
HN.D.25.Sti.C B1-25/Z	0-1103108-1	128	HUT.13.P-GRAU	2-1106005-7	190	HVT.48.Sti.C	2-1104016-3	134
HN.D.40.Bu.C	2-1103111-3	109	HUT.16.MS	3-1106006-9	190	HVT.8.Bu.C	2-1104002-3	68
HN.D.40.Bu.C	2-1103111-3	157	HUT.16.P-GRAU	3-1106005-7	190	HVT.8.Sti.C	2-1104000-3	68
HN.D.40.Sti.C	2-1103110-3	109	HUT.21.MS	4-1106006-9	190	HVT-C-Bu.Ag.0,13-0,4 mm ²	6-1105301-1	38
HN.D.40.Sti.C	2-1103110-3	157	HUT.21.P-GRAU	4-1106005-7	190	HVT-C-Bu.Ag.0,5 mm ²	1-1105301-1	38
HN.D.64.Bu.C	2-1103113-3	135	HUT.29.MS	5-1106006-9	190	HVT-C-Bu.Ag.0,75-1,0 mm ²	2-1105301-1	38
HN.D.64.Bu.C	2-1103113-3	169	HUT.29.P-GRAU	5-1106005-7	190	HVT-C-Bu.Ag.1,5 mm ²	3-1105301-1	38
HN.D.64.Sti.C	2-1103112-3	135	HUT.36.MS	6-1106006-9	190	HVT-C-Bu.Ag.2,5 mm ²	4-1105301-1	38
HN.D.64.Sti.C	2-1103112-3	169	HUT.36.P-GRAU	6-1106005-7	190	HVT-C-Bu.Ag.4,0 mm ²	5-1105301-1	38
HN.D.7.Bu.C	2-1103103-3	47	HUT.42.MS	7-1106006-9	190	HVT-C-Bu.Au.0,13-0,4 mm ²	6-1105301-2	38
HN.D.7.Bu.C/250V	2-1103101-3	47	HUT.42.P-GRAU	7-1106005-7	190	HVT-C-Bu.Au.0,5 mm ²	1-1105301-2	38
HN.D.7.Sti.C	2-1103102-3	47	HUT.M16.MS	1-1102770-6	190	HVT-C-Bu.Au.0,75-1,0 mm ²	2-1105301-2	38
HN.D.7.Sti.C/250V	2-1103100-3	47	HUT.M16.P	1-1102771-6	190	HVT-C-Bu.Au.1,5 mm ²	3-1105301-2	38
HN.D.8.Bu.C	2-1103105-3	47	HUT.M20.MS	2-1102770-0	190	HVT-C-Bu.Au.2,5 mm ²	4-1105301-2	38
HN.D.8.Sti.C	2-1103104-3	47	HUT.M20.P	2-1102771-0	190	HVT-C-Bu.Au.4,0 mm ²	5-1105301-2	38
HN.D-C-Bu.Ag.0,14-0,37	1-1105051-1	34	HUT.M25.MS	2-1102770-5	190	HVT-C-Sti.Ag.0,13-0,4 mm ²	6-1105300-1	38
HN.D-C-Bu.Ag.0,5	2-1105051-1	34	HUT.M25.P	2-1102771-5	190	HVT-C-Sti.Ag.0,5 mm ²	1-1105300-1	38
HN.D-C-Bu.Ag.0,75-1,0	3-1105051-1	34	HUT.M32.MS	3-1102770-2	190	HVT-C-Sti.Ag.0,75-1,0 mm ²	2-1105300-1	38
HN.D-C-Bu.Ag.1,5	4-1105051-1	34	HUT.M32.P	3-1102771-2	190	HVT-C-Sti.Ag.1,5 mm ²	3-1105300-1	38
HN.D-C-Bu.Ag.2,5	5-1105051-1	34	HUT.M40.MS	4-1102770-0	190	HVT-C-Sti.Ag.2,5 mm ²	4-1105300-1	38

Sortiert nach Bezeichnung/Sorted by description

Bestelltext	Best-Nr.	Seite	Bestelltext	Best-Nr.	Seite	Bestelltext	Best-Nr.	Seite
HVT-C-Sti.Ag.4,0 mm²	5-1105300-1	38	MDL2-GR.U-8.B5-8	0-1108780-7	171	Schellenset 8 mm	5-1106302-9	213
HVT-C-Sti.Au.0,13-0,4 mm²	6-1105300-2	38	MDL2-GR.U-8.B5-8	0-1108780-7	203	Schellenset 9 mm	6-1106302-9	183
HVT-C-Sti.Au.0,5 mm²	1-1105300-2	38	MDL-SBS.BG3	2-1106310-9	213	Schellenset 9 mm	6-1106302-9	213
HVT-C-Sti.Au.0,75-1,0 mm²	2-1105300-2	38	MDL-SBS.BG4	2-1106311-9	213	Schirmschiene gerade	0-1110505-1	182
HVT-C-Sti.Au.1,5 mm²	3-1105300-2	38	MDL-SBS.BG6	2-1106312-9	213	SDE SAHT 28-24 DYN D-3S	91565-1	33
HVT-C-Sti.Au.2,5 mm²	4-1105300-2	38	MDL-SBS.BG8	2-1106313-9	213	SDE SAHT 16-14 DYN D-ZL	91560-1	33
HVT-C-Sti.Au.4,0 mm²	5-1105300-2	38	MJ Plug Cat 5e	5-569550-4	199	SDE SAHT 20-16 DYN D-3L	91558-1	33
INS.-EXTR. TOOL	726363-1	32	O-RING.PG11.SCHW	1-1106053-1	193	SDE SAHT 20-16 DYNAMIC D5-SS	91596-1	33
INSERT/EXTRACT TOOL ASSEMBLY	91285-1	32	O-RING.PG11.VITON	1-1106053-2	193	SDE SAHT 22-18 DYNAMIC D2-M	91595-1	33
IP65-Dichtset M3x6+PD	0-1103028-2	189	O-RING.PG13.SCHW	2-1106053-1	193	SDE SAHT 24-20 DYN D-3M	91559-1	33
IP65-Dichtset M3x8	0-1103028-1	189	O-RING.PG13.VITON	2-1106053-2	193	SDE SAHT 28-24 D-2S DYNAMIC	91576-1	33
KX.VT.Bu.0,8/3,5/6,1	0-1108601-1	43	O-RING.PG16.SCHW	3-1106053-1	193	SET CZ-HF.60.M	0-1110956-7	42
KX.VT.Bu.1,4/6,3/10,0	0-1108629-1	43	O-RING.PG21.SCHW	4-1106053-1	193	SET-Erdungsband 120 mm	2-1106303-9	183
KX.VT.Bu.3,0/7,3/10,8	0-1108617-1	43	O-RING.PG29.SCHW	5-1106053-1	193	SET-Erdungsband 120 mm	2-1106303-9	213
KX.VT.Sti.0,8/3,5/6,1	0-1108600-1	43	O-RING.PG29.VITON	5-1106053-2	193	SET-Erdungsband 220 mm	3-1106303-9	183
KX.VT.Sti.1,4/6,3/10,0	0-1108628-1	43	O-RING.PG36.SCHW	6-1106053-1	193	SET-Erdungsband 220 mm	3-1106303-9	213
KX.VT.Sti.3,0/7,3/10,8	0-1108616-1	43	O-RING.PG42.SCHW	7-1106053-1	193	SET-Erdungsband 90 mm	1-1106303-9	183
KX.VT-AWZG	1-1105752-8	43	O-RING.PG42.VITON	7-1106053-2	193	SET-Erdungsband 90 mm	1-1106303-9	213
KX-AWZG	0-0305183-8	43	Pin Dia 2,5 (Sn) 0,2-0,4 mm² Loose piece	962966-1	36	SET-HF.13/16-13.Bu	0-1110951-2	175
KX-RG.58.Bu	1-1105351-1	43	Pin Dia 2,5 (Sn) 0,2-0,4 mm² Strip Form	929962-1	36	SET-HF.13/16-13.Sti	0-1110950-2	175
KX-RG.58.Sti	1-1105350-1	43	Pin Dia 2,5 (Sn) 0,5-1,0 mm² Loose piece	962967-1	36	SET-HFE-13.Bu	0-1110951-4	175
KX-RG.59.Bu	2-1105351-1	43	Pin Dia 2,5 (Sn) 0,5-1,0 mm² Strip Form	929963-1	36	SET-HFE-13.Sti	0-1110950-4	175
KX-RG.59.Sti	2-1105350-1	43	Pin Dia 2,5 (Sn) 1,0-2,5 mm² Strip Form	929964-1	36	SET-Schrauben	1-1106304-9	183
LWL-Zentrierhülse	0-1102921-1	44	Pin Dia 2,5 (Sn) 1,0-2,5 mm² Loose piece	962968-1	36	SET-Schrauben	1-1106304-9	213
MDL.E.TWIN.Bu	0-1108786-1	198	Pin Dia 2,5 (Sn) 2,5-4,0 mm² Loose piece	962969-1	36	Sich-Straif.HVG.C	0-1110984-4	59
MDL.E.TWIN.Sti	0-1108785-1	198	Pin Dia 2,5 (Sn) 2,5-4,0 mm² Strip Form	929965-1	36	SKP.6	0-1110684-3	185
MDL.HFE.C-6mm	0-1110957-1	200	Pin S 20 DF 0,08-0,2 AG Loose piece	1-66507-0	32	SKP.6.F	0-1106258-3	185
MDL.2.2+2.Bu.C	0-1103019-2	194	Pin S 20 DF 0,08-0,2 AG Strip Form	66507-4	32	SKP.6/R	0-1110684-4	185
MDL.2.2+2.Sti.C	0-1103019-1	194	Pin S 20 DF 0,08-0,2 Loose piece	66507-9	32	SKP.6/R.F	0-1106259-3	185
MDL.2.3+4.Bu.C	0-1103018-2	195	Pin S 20 DF 0,08-0,2 Strip Form	66507-3	32	SKP.8	0-1110661-3	185
MDL.2.3+4.Sti.C	0-1103018-1	195	Pin S 20 DF 0,2-0,6 AG Loose piece	1-66506-0	32	SKP.8.F	0-1106258-4	185
MDL.2.45.JACK.2	0-1108812-2	199	Pin S 20 DF 0,2-0,6 AG Strip Form	66506-4	32	SKP.8/R	0-1110661-4	185
MDL.2.45.JACK.5e	0-1108812-1	199	Pin S 20 DF 0,2-0,6 Loose piece	66506-9	32	SKP.8/R.F	0-1106259-4	185
MDL.2.45.PLUG	0-1108813-1	199	Pin S 20 DF 0,2-0,6 Strip Form	66506-3	32	Socket Dia 2,5 (Sn) 0,2-0,4 mm² Loose	962976-1	36
MDL.2.8.Bu.C	0-1103015-2	195	QUICK-IN-QM	0-1106516-1	178	Socket Dia 2,5 (Sn) 0,2-0,4 mm² Strip Form	929969-1	36
MDL.2.8.Sti.C	0-1103015-1	195	QUICK-IN-QSB	0-1106515-1	178	Socket Dia 2,5 (Sn) 0,5-1,0 mm² Loose	962977-1	36
MDL.2.AIR.Bu	0-1103025-2	200	REDU.13/09.MS.8	8-1106062-6	192	Socket Dia 2,5 (Sn) 0,5-1,0 mm² Strip Form	929970-1	36
MDL.2.AIR.Sti	0-1103025-1	200	REDU.13/11.MS.8	2-1106062-6	192	Socket Dia 2,5 (Sn) 1,0-2,5 mm² Strip Form	929971-1	36
MDL.2.Blindmodul	0-1103014-1	200	REDU.16/11.MS.8	9-1106062-6	192	Socket Dia 2,5 (Sn) 1,0-2,5 mm² Loose	962978-1	36
MDL.2.HD.18.Bu.C	0-1103016-2	196	REDU.16/13.MS.8	3-1106062-6	192	Socket Dia 2,5 (Sn) 2,5-4,0 mm² Loose	962979-1	36
MDL.2.HD.18.Sti.C	0-1103016-1	196	REDU.21/13.MS.8	0-1106062-6	192	Socket Dia 2,5 (Sn) 2,5-4,0 mm² Strip Form	929972-1	36
MDL.2.HN.D.1+2.Bu.C	0-1103024-2	194	REDU.21/16.MS.8	4-1106062-6	192	Socket S 20 DF 0,08-0,2 AG Loose piece	1-66505-0	32
MDL.2.HN.D.1+2.Sti.C	0-1103024-1	194	REDU.29/16.MS.8	0-1106062-7	192	Socket S 20 DF 0,08-0,2 AG Strip Form	66505-4	32
MDL.2.HN.D.15.Bu.C	0-1103017-2	196	REDU.29/21.MS.8	5-1106062-6	192	Socket S 20 DF 0,08-0,2 Loose piece	66505-9	32
MDL.2.HN.D.15.Sti.C	0-1103017-1	196	REDU.36/21.MS.8	1-1106062-7	192	Socket S 20 DF 0,08-0,2 Strip Form	66505-3	32
MDL.2.HN.D.18.Bu.C	0-1103076-2	196	REDU.36/29.MS.8	6-1106062-6	192	Socket S 20 DF 0,2-0,6 AG Loose piece	1-66504-0	32
MDL.2.HN.D.18.Sti.C	0-1103076-1	196	RS-M3	1-1106107-1	179	Socket S 20 DF 0,2-0,6 AG Strip Form	66504-4	32
MDL.2.KX.Bu	0-1103021-2	198	RSZ.BAS	1-1105850-8	34	Socket S 20 DF 0,2-0,6 Loose piece	66504-9	32
MDL.2.KX.Sti	0-1103021-1	198	RSZ.BAS	1-1105850-8	35	Socket S 20 DF 0,2-0,6 Strip Form	66504-3	32
MDL.2.TX.4.5,4.Bu.C	0-1103023-2	198	RSZ.BAS	1-1105850-8	37	SPB-M3	1-1106100-1	180
MDL.2.TX.4.5,4.Sti.C	0-1103023-1	198	RSZ.BAS	1-1105850-8	38	S-Schelle groß	0-1102081-1	182
MDL.2.TX.4.8,5.Bu.C	0-1103022-2	198	RSZ.BAS	1-1105850-8	39	S-Schelle klein	0-1102082-1	182
MDL.2.TX.4.8,5.Sti.C	0-1103022-1	198	RSZ.BAS	1-1105850-8	40	STR ACT DAHT MIN COAXICON	0-0045740-2	43
MDL.2.VT-KX.Bu	0-1103020-2	199	RSZ.BAS	1-1105850-8	41	TDS.11.M	1-1106001-9	189
MDL.2.VT-KX.Sti	0-1103020-1	199	RSZ.HE/HA-LC 0,14-4 mm²	1-1105852-8	34	TDS.13.M	2-1106001-9	189
MDL2-GR.0/U-3	0-1108784-1	72	RSZ.HE/HA-LC 0,14-4 mm²	1-1105852-8	37	TDS.16.M	3-1106001-9	189
MDL2-GR.0/U-3	0-1108784-1	201	RSZ.HE/HA-LC 0,14-4 mm²	1-1105852-8	38	TDS.21.M	4-1106001-9	189
MDL2-GR.0-4.B1-2	0-1108783-1	86	RSZ.HE-HN.D-HVT	1-1105851-8	34	TDS.29.M	5-1106001-9	189
MDL2-GR.0-6.B1-3	0-1108782-1	114	RSZ.HE-HN.D-HVT	1-1105851-8	37	TDS.36.M	6-1106001-9	189
MDL2-GR.0-6.B1-3	0-1108782-1	159	RSZ.HE-HN.D-HVT	1-1105851-8	38	TDS.42.M	7-1106001-9	189
MDL2-GR.0-6.B1-3	0-1108782-1	202	RSZ.HSM-LC 0,14+2,5 mm²	1-1105870-8	40	THURRED HEAD TYCO	523168-5	34
MDL2-GR.0-6.B1-3	0-1108782-1	203	RSZ.HSM-LC 4+10 mm²	2-1105870-8	40	Turnet	523168-5	38
MDL2-GR.0-6.B4-6	0-1108782-4	203	RSZ.HSS-LC 10+16 mm²	2-1105652-8	41	Turnet	523168-6	37
MDL2-GR.0-6.B4-6	0-1108782-4	203	RSZ.HSS-LC 6+25 mm²	1-1105652-8	41	Turnet	523168-7	39
MDL2-GR.0-8.B1-4	0-1108780-1	138	SAHT W/OUT DIES	69710-1	43	UPM	1-1102975-9	177
MDL2-GR.0-8.B1-4	0-1108780-1	171	SB.BG.3.SET	1-1106305-9	181	„Ü-PG.11-NPT3/8“	1-1106066-8	192
MDL2-GR.0-8.B1-4	0-1108780-1	202	SB.BG.4.SET	1-1106306-9	181	„Ü-PG.13-NPT1/2“	2-1106066-8	192
MDL2-GR.0-8.B1-4	0-1108780-1	203	SB.BG.6.SET	1-1106307-9	181	„Ü-PG.16-NPT1/2“	3-1106066-8	192
MDL2-GR.0-8.B5-8	0-1108780-6	171	SB.BG.8.SET	1-1106308-9	181	„Ü-PG.21-NPT3/4“	4-1106066-8	192
MDL2-GR.0-8.B5-8	0-1108780-6	203	SB.HSS.BG.8	1-1106309-9	181	„Ü-PG.36-NPT1.1/4“	6-1106066-8	192
MDL2-GR.U-4.B1-2	0-1108783-2	86	Schellenset 10 mm	7-1106302-9	183	ZE-HSB	0-1108723-1	178
MDL2-GR.U-6.B1-3	0-1108782-2	114	Schellenset 10 mm	7-1106302-9	213	ZW.ST.11.SKT-MS	1-1106057-4	191
MDL2-GR.U-6.B1-3	0-1108782-2	159	Schellenset 4,5 mm	1-1106302-9	183	ZW.ST.13.SKT-MS	2-1106057-4	191
MDL2-GR.U-6.B1-3	0-1108782-2	202	Schellenset 4,5 mm	1-1106302-9	213	ZW.ST.16.SKT-MS	3-1106057-4	191
MDL2-GR.U-6.B1-3	0-1108782-2	203	Schellenset 5 mm	2-1106302-9	183	ZW.ST.21.SKT-MS	4-1106057-4	191
MDL2-GR.U-6.B4-6	0-1108782-5	159	Schellenset 5 mm	2-1106302-9	213	ZW.ST.29.SKT-MS	5-1106057-4	191
MDL2-GR.U-6.B4-6	0-1108782-5	203	Schellenset 6 mm	3-1106302-9	183	ZW.ST.36.SKT-MS	6-1106057-4	191
MDL2-GR.U-8.B1-4	0-1108780-2	138	Schellenset 6 mm	3-1106302-9	213	ZW.ST.42.SKT-MS	7-1106057-4	191
MDL2-GR.U-8.B1-4	0-1108780-2	171	Schellenset 7 mm	4-1106302-9	183			
MDL2-GR.U-8.B1-4	0-1108780-2	202	Schellenset 7 mm	4-1106302-9	213			
MDL2-GR.U-8.B1-4	0-1108780-2	203	Schellenset 8 mm	5-1106302-9	183			

Crossreferenz HTS – Tyco

HTS PN	Tyco PN	Seite	HTS PN	Tyco PN	Seite	HTS PN	Tyco PN	Seite	HTS PN	Tyco PN	Seite
3200002	1-1102975-9	177	41634881	1-1102179-2	154	42612480	1-1102343-6	143	43122433	2-1103640-9	168
3300002	1-1102978-9	177	41634897	1-1102181-2	154	42612496	1-1102345-6	143	43122441	2-1103640-3	168
41000041	1-1106100-1	180	41681000	2-1106206-7	184	42613281	1-1102362-6	162	43123541	2-1104012-3	134
41100300	1-1103400-1	45	41681600	2-1106208-7	184	42613297	1-1102364-6	162	43124841	2-1104016-3	134
41100400	1-1103402-1	45	41681600	2-1106208-7	184	42620679	1-1102253-2	75	43150019	1-1105100-1	37
41101000	1-1103414-1	60	41700377	1-1102112-2	50	42620695	1-1102255-2	75	43150020	2-1105100-1	37
41101600	1-1103416-1	100	41721069	1-1102133-2	65	42624881	1-1107001-2	173	43150021	3-1105100-1	37
41101600	1-1103416-1	152	41721669	1-1102152-2	105	42624882	1-1107005-2	173	43150022	4-1105100-1	37
41101600	1-1103416-1	166	42100662	1-1104204-1	113	42624897	1-1107003-2	173	43150023	5-1105100-1	37
41101627	1-1103416-7	152	42100662	1-1104204-1	156	42624898	1-1107007-2	173	43220018	6-1105301-1	38
41101627	1-1103416-7	166	42100663	1-1104206-1	156	42631079	1-1102274-2	93	43220019	1-1105301-1	38
41101628	1-1103416-8	152	42200662	1-1104205-1	113	42631095	1-1102276-2	93	43220020	2-1105301-1	38
41101628	1-1103416-8	166	42200662	1-1104205-1	156	42631680	1-1102299-2	121	43220021	3-1105301-1	38
41101629	1-1103416-9	166	42200663	1-1104207-1	156	42631696	1-1102301-2	121	43220022	4-1105301-1	38
41121040	2-1103414-3	60	42300669	1-1102243-7	73	42632480	1-1102331-2	146	43220023	5-1105301-1	38
41121627	2-1103416-7	152	42301069	1-1102267-6	87	42632496	1-1102333-2	146	43220640	1-1103635-1	66
41121627	2-1103416-7	166	42301070	1-1102270-6	87	42634881	1-1102391-2	173	43220641	2-1103635-3	66
41121640	2-1103416-3	100	42301670	1-1102295-6	115	42634882	1-1102395-2	173	43220841	2-1104002-3	68
41121640	2-1103416-3	152	42302470	1-1102325-6	140	42634897	1-1102393-2	173	43221040	1-1103637-1	81
41121640	2-1103416-3	166	42302471	1-1102328-6	140	42634898	1-1102397-2	173	43221041	2-1103637-3	81
41200300	1-1103401-1	45	42303271	1-1102351-6	160	42641079	1-1102286-2	94	43221441	2-1104006-3	83
41200400	1-1103403-1	45	42304871	1-1102382-7	172	42641095	1-1102288-2	94	43221626	1-1103639-1	155
41201000	1-1103415-1	60	42304872	1-1102385-7	172	42641680	1-1102308-2	122	43221631	2-1103639-9	155
41201600	1-1103417-1	100	42304873	1-1102388-7	172	42641696	1-1102310-2	122	43221641	2-1103639-3	106
41201600	1-1103417-1	152	42320669	1-1102240-7	73	42642480	1-1102343-2	146	43221641	2-1103639-3	155
41201600	1-1103417-1	166	42321069	1-1102261-6	87	42642496	1-1102345-2	146	43222341	2-1104010-3	108
41201627	1-1103417-7	152	42321070	1-1102264-6	87	42643281	1-1102362-2	164	43222433	2-1103641-9	168
41201627	1-1103417-7	166	42321670	1-1102292-6	115	42700669	1-1102258-2	76	43222440	1-1103641-1	168
41201628	1-1103417-8	152	42322470	1-1102316-6	139	42701069	1-1102279-1	89	43222441	2-1103641-3	168
41201628	1-1103417-8	166	42322471	1-1102319-6	139	42701070	1-1102282-1	89	43223541	2-1104014-3	134
41201629	1-1103417-9	166	42323271	1-1102348-6	160	42701670	1-1102304-1	117	43224841	2-1104018-3	134
41201629	1-1103417-9	166	42324871	1-1102373-7	172	42702470	1-1102336-1	141	43250019	1-1105101-1	37
41221040	2-1103415-3	60	42324872	1-1102376-7	172	42702471	1-1102339-1	141	43250020	2-1105101-1	37
41221627	2-1103417-7	152	42324873	1-1102379-7	172	42703271	1-1102359-1	161	43250021	3-1105101-1	37
41221627	2-1103417-7	166	42331005	0-1108713-1	79	42721069	1-1102279-2	94	43250022	4-1105101-1	37
41221640	2-1103417-3	100	42351670	1-1102295-1	118	42721070	1-1102282-2	94	43250023	5-1105101-1	37
41300377	1-1102101-7	49	42352470	1-1102325-1	142	42721670	1-1102304-2	122	43990400	1-1105850-8	34
41301069	1-1102120-7	63	42352471	1-1102328-1	142	42722470	1-1102336-2	147	43990400	1-1105850-8	35
41301669	1-1102139-7	103	42361069	1-1102267-1	90	42722471	1-1102339-2	147	43990400	1-1105850-8	37
41303270	1-1102158-6	130	42371069	1-1102261-1	90	42800669	1-1102240-3	77	43990400	1-1105850-8	38
41304871	1-1102175-7	153	42371670	1-1102292-1	118	42801069	1-1102261-3	96	43990400	1-1105850-8	39
41306471	1-1102027-7	167	42372470	1-1102316-1	142	42801670	1-1102292-3	123	43990400	1-1105850-8	40
41306472	1-1102030-7	167	42372471	1-1102319-1	142	42802470	1-1102316-3	148	43990400	1-1105850-8	41
41306473	1-1102033-7	167	42373271	1-1102348-1	162	42802471	1-1102319-3	148	43990410	1-1105851-8	34
41321069	1-1102117-7	63	42401069	1-1102267-7	92	42803271	1-1102348-3	165	43990410	1-1105851-8	37
41321669	1-1102136-7	103	42401670	1-1102295-7	120	42850600	1-1102244-8	77	43990410	1-1105851-8	38
41323270	1-1102155-6	130	42402470	1-1102325-7	145	42851000	1-1102271-8	96	43990412	1-1105652-8	41
41324871	1-1102172-7	153	42402471	1-1102328-7	145	42851600	1-1102296-8	123	43990413	2-1105652-8	41
41326471	1-1102002-7	167	42403271	1-1102351-7	163	42852400	1-1102291-8	149	43990414	1-1105852-8	34
41326472	1-1102005-7	167	42421069	1-1102261-7	92	42853200	1-1102352-8	165	43990414	1-1105852-8	37
41326473	1-1102008-7	167	42421670	1-1102292-7	120	42860679	1-1102249-8	78	43990414	1-1105852-8	38
41330377	1-1102103-7	49	42422470	1-1102316-7	144	42860695	1-1102251-8	78	47000011	1-1106001-9	189
41353270	1-1102158-1	131	42422471	1-1102319-7	144	42861079	1-1102274-8	97	47000013	2-1106001-9	189
41373270	1-1102155-1	131	42423271	1-1102348-7	163	42861095	1-1102276-8	97	47000016	3-1106001-9	189
41500300	1-1102105-2	49	42500600	1-1102244-2	74	42861680	1-1102299-8	124	47000021	4-1106001-9	189
41501000	1-1102121-2	64	42501000	1-1102271-1	88	42861696	1-1102301-8	124	47000029	5-1106001-9	189
41501600	1-1102140-2	104	42501600	1-1102296-1	116	42862480	1-1102331-8	149	47000036	6-1106001-9	189
41503200	1-1102160-1	130	42502400	1-1102291-1	140	42862496	1-1102333-8	149	47000042	7-1106001-9	189
41513200	1-1102165-1	131	42503200	1-1102352-1	160	42863281	1-1102354-8	165	47001113	1-1106058-5	192
41520300	1-1102106-2	49	42511000	1-1102283-6	91	42863297	1-1102356-8	165	47001116	7-1106058-5	192
41521000	1-1102122-2	64	42511600	1-1102305-6	119	42900669	1-1102205-3	77	47001316	2-1106058-5	192
41521600	1-1102141-2	104	42512400	1-1102340-6	143	42901080	1-1102211-3	96	47001321	1-1106058-5	192
41524800	1-1102177-2	153	42513200	1-1102360-6	162	42901670	1-1102220-3	123	47001621	3-1106058-5	192
41526400	1-1102009-2	167	42520600	1-1102246-2	74	42902470	1-1102229-3	148	47002129	4-1106058-5	192
41534800	1-1102176-2	153	42524800	1-1102389-2	173	42902471	1-1102232-3	148	47002936	5-1106058-5	192
41550300	1-1102107-2	49	42531000	1-1102271-2	93	42911069	1-1102211-6	87	47010011	1-1106066-8	192
41550367	1-1102110-2	50	42531600	1-1102296-2	121	42911070	1-1102214-6	87	47010013	2-1106066-8	192
41550377	1-1102109-2	50	42532400	1-1102291-2	145	42911670	1-1102220-6	115	47010016	3-1106066-8	192
41590379	1-1102114-2	50	42533200	1-1102352-2	164	42931069	1-1102211-1	90	47010021	4-1106066-8	192
41601079	1-1102124-2	64	42541000	1-1102283-2	93	43120018	6-1105300-1	38	47010036	6-1106066-8	192
41601095	1-1102126-2	64	42541600	1-1102305-2	121	43120019	1-1105300-1	38	47041309	8-1106062-6	192
41601679	1-1102143-2	104	42542400	1-1102340-2	145	43120020	2-1105300-1	38	47041311	2-1106062-6	192
41601695	1-1102145-2	104	42543200	1-1102360-2	164	43120021	3-1105300-1	38	47041611	9-1106062-6	192
41603280	1-1102162-1	130	42600679	1-1102249-2	74	43120022	4-1105300-1	38	47041613	3-1106062-6	192
41603296	1-1102164-1	130	42600695	1-1102251-2	74	43120023	5-1105300-1	38	47042113	0-1106062-6	192
41613280	1-1102167-1	131	42601079	1-1102274-1	88	43120640	1-1103634-1	66	47042116	4-1106062-6	192
41613296	1-1102169-1	131	42601095	1-1102276-1	88	43120641	2-1103634-3	66	47042916	0-1106062-7	192
41621079	1-1102128-2	65	42601680	1-1102299-1	116	43120841	2-1104000-3	68	47042921	5-1106062-6	192
41621095	1-1102130-2	65	42601696	1-1102301-1	116	43121040	1-1103636-1	81	47043621	1-1106062-7	192
41621679	1-1102147-2	105	42602480	1-1102331-1	141	43121041	2-1103				

Crossreferenz HTS – Tyco

Table with 12 columns: HTS PN, Tyco PN, Seite, HTS PN, Tyco PN, Seite, HTS PN, Tyco PN, Seite, HTS PN, Tyco PN, Seite. Contains cross-reference data for HTS and Tyco connectors.

Crossreferenz HTS – Tyco

HTS PN	Tyco PN	Seite	HTS PN	Tyco PN	Seite	HTS PN	Tyco PN	Seite	HTS PN	Tyco PN	Seite
214922541	2-1103109-3	128	5142641095	2-1102288-2	94	5149636481	2-1103350-2	146	5169604080	4-1102726-5	126
2149224041	2-1103111-3	109	5142641680	2-1102308-2	122	5149642480	2-1102521-2	94	5169604096	4-1102727-5	126
2149224041	2-1103111-3	157	5142641696	2-1102310-2	122	5149642481	2-1102525-2	94	5169606481	4-1102734-5	151
2149226441	2-1103113-3	135	5142642480	2-1102343-2	146	5149642497	2-1102527-2	94	5169606497	4-1102735-5	151
2149226441	2-1103113-3	169	5142700669	2-1102258-2	76	5149644080	2-1102589-2	122	5169906471	4-1102732-5	150
2149230072	2-1103213-3	157	5142701069	2-1102279-1	89	5149644081	2-1102593-2	122	5169906472	4-1102733-5	150
2149230108	2-1103221-3	169	5142701670	2-1102304-1	117	5149644096	2-1102591-2	122	9000001197	1-1106302-9	183
2149250018	1-1105051-1	34	5142702470	2-1102336-1	141	5149644097	2-1102595-2	122	9000001197	1-1106302-9	213
2149250019	2-1105051-1	34	5142800669	2-1102240-3	77	5149646481	2-1103364-2	146	9000001198	2-1106302-9	183
2149250020	3-1105051-1	34	5142801069	2-1102261-3	96	5149701670	2-1102489-2	76	9000001198	2-1106302-9	213
2149250021	4-1105051-1	34	5142801670	2-1102292-3	123	5149704071	2-1102587-1	117	9000001199	3-1106302-9	183
2149250022	5-1105051-1	34	5142802470	2-1102316-3	148	5149722471	2-1102519-2	94	9000001199	3-1106302-9	213
5141300377	2-1102101-7	49	5142803271	2-1102348-3	165	5149801670	2-1102461-3	77	9000001200	4-1106302-9	183
5141500300	2-1102105-2	49	5142804873	2-1102234-3	174	5149802470	2-1102496-3	96	9000001200	4-1106302-9	213
5141501000	2-1102121-2	64	5142804874	2-1102236-3	174	5149802471	2-1102499-3	96	9000001201	5-1106302-9	183
5141550300	2-1102107-2	49	5142850600	2-1102244-8	77	5149804070	2-1102564-3	123	9000001201	5-1106302-9	213
5142300669	2-1102243-7	73	5142851000	2-1102271-8	96	5149804071	2-1102567-3	123	9000001202	6-1106302-9	183
5142301069	2-1102267-6	87	5142851600	2-1102296-8	123	5149806471	2-1103338-3	148	9000001202	6-1106302-9	213
5142301070	2-1102270-6	87	5142852400	2-1102291-8	149	5149861680	2-1102472-8	78	9000001203	7-1106302-9	183
5142301670	2-1102295-6	115	5142853200	2-1102352-8	165	5149861696	2-1102474-8	78	9000001203	7-1106302-9	213
5142302470	2-1102325-6	140	5142854800	2-1102237-8	174	5149862481	2-1102511-8	97	9000001204	1-1106303-9	183
5142302471	2-1102328-6	140	5142860679	2-1102249-8	78	5149862497	2-1102513-8	97	9000001204	1-1106303-9	213
5142303271	2-1102351-6	160	5142860695	2-1102251-8	78	5149866481	2-1103350-8	149	9000001205	1-1106304-9	183
5142304872	2-1102385-7	172	5142861079	2-1102274-8	97	5149866497	2-1103352-8	149	9000001205	1-1106304-9	213
5142320669	2-1102240-7	73	5142861095	2-1102276-8	97	5149906472	2-1102408-3	148	9000001457	1-1106301-9	182
5142321069	2-1102261-6	87	5142861680	2-1102299-8	124	5168300367	2-1102600-5	53	9000001533	2-1106303-9	183
5142321070	2-1102264-6	87	5142861696	2-1102301-8	124	5168301669	2-1102635-5	79	9000001533	2-1106303-9	213
5142321670	2-1102292-6	115	5142862480	2-1102331-8	149	5168301670	2-1102637-5	79	9000001583	0-1110501-1	182
5142322470	2-1102316-6	139	5142900669	2-1102205-3	77	5168302469	2-1102644-5	98	9000001585	0-1102081-1	182
5142322471	2-1102319-6	139	5142901080	2-1102211-3	96	5168304071	2-1102655-5	125	9000001656	3-1106303-9	183
5142323271	2-1102348-6	139	5142901670	2-1102220-3	123	5168306471	2-1102664-5	150	9000001656	3-1106303-9	213
5142324872	2-1102376-7	172	5142902471	2-1102232-3	148	5168321669	2-1102631-5	79	9000002146	0-1102082-1	182
5142361069	2-1102267-1	90	5142910669	2-1102205-7	73	5168321670	2-1102633-5	79	9041001219	0-1107196-1	186
5142371069	2-1102261-1	90	5142911069	2-1102211-6	87	5168322470	2-1102642-5	98	9041001220	0-1107196-2	186
5142372471	2-1102319-1	142	5142911070	2-1102214-6	87	5168324071	2-1102651-5	125	9041001221	0-1107196-3	186
5142401069	2-1102267-7	92	5142921069	2-1102211-7	92	5168326471	2-1102660-5	150	9041001222	0-1107197-1	186
5142401670	2-1102295-7	120	5149301670	2-1102467-7	74	5168500300	2-1102603-5	53	9041001223	0-1107197-2	186
5142402471	2-1102328-7	145	5149302470	2-1102502-6	87	5168501600	2-1102638-5	79	9041001224	0-1107197-3	186
5142403271	2-1102305-7	163	5149302471	2-1102505-6	87	5168502400	2-1102647-5	98	9041001328	2-1103100-3	47
5142421005	2-1102259-7	92	5149304070	2-1102570-6	116	5168504000	2-1102656-5	125	9041001329	2-1103101-3	47
5142421069	2-1102261-7	92	5149304071	2-1102573-6	116	5168506400	2-1102665-5	151	9041001330	2-1103000-3	48
5142421670	2-1102292-7	120	5149306470	2-1103341-6	140	5168516400	2-1102628-5	151	9041001331	2-1103001-3	48
5142422470	2-1102316-7	144	5149306471	2-1103344-6	140	5168530300	2-1102602-5	53	9043001534	2-1104200-3	137
5142422471	2-1102319-7	144	5149320871	2-1102411-6	139	5168550367	2-1102601-5	54	9043001535	2-1104202-3	137
5142423271	2-1102348-7	163	5149320872	2-1102414-6	140	5168551600	2-1102606-5	79	9043001550	3-1105150-1	41
5142500600	2-1102244-2	74	5149321670	2-1102461-7	73	5168552400	2-1102612-5	99	9043001551	4-1105150-1	41
5142501000	2-1102271-1	88	5149322470	2-1102496-6	87	5168554000	2-1102618-5	125	9043001552	5-1105150-1	41
5142501600	2-1102296-1	116	5149322471	2-1102499-6	87	5168556400	2-1102626-5	151	9043001553	3-1105151-1	41
5142502400	2-1102291-1	140	5149324070	2-1102564-6	115	5168601679	2-1102604-5	80	9043001554	4-1105151-1	41
5142503200	2-1102352-1	160	5149324071	2-1102567-6	115	5168601695	2-1102605-5	80	9043001555	5-1105151-1	41
5142511000	2-1102283-6	91	5149326470	2-1103336-6	139	5168602496	2-1102611-5	99	9043001622	1-1105653-8	42
5142511600	2-1102305-6	119	5149326471	2-1103338-6	139	5168604066	2-1102617-5	126	9043001622	1-1105653-8	42
5142512400	2-1102340-6	143	5149354070	2-1102570-1	118	5168606496	2-1102625-5	151	9043001640	3-1105150-2	41
5142513200	2-1102360-6	162	5149356471	2-1103344-1	142	5168690300	4-1106200-5	54	9043001641	4-1105150-2	41
5142520600	2-1102246-2	74	5149362470	2-1102502-1	90	5168691600	4-1106201-5	80	9043001642	5-1105150-2	41
5142524800	2-1102389-2	173	5149362471	2-1102505-1	90	5168691600	4-1106201-5	80	9043001643	3-1105151-2	41
5142531000	2-1102271-2	93	5149372470	2-1102496-1	90	5168691600	4-1106201-5	185	9043001644	4-1105151-2	41
5142531600	2-1102296-2	121	5149372471	2-1102499-1	90	5168692400	4-1106202-5	99	9043001645	5-1105151-2	41
5142532400	2-1102291-2	145	5149374070	2-1102564-1	118	5168692400	4-1106202-5	185	9043001675	7-1103640-1	168
5142533200	2-1102352-2	164	5149374071	2-1102567-1	118	5168694000	4-1106203-5	126	9043001676	7-1103641-1	168
5142541000	2-1102283-2	93	5149376471	2-1103338-1	142	5168694000	4-1106203-5	185	9043001949	4-1105250-1	40
5142541600	2-1102305-2	121	5149402471	2-1102505-7	92	5168696400	4-1106204-5	151	9043001950	5-1105250-1	40
5142542400	2-1102340-2	145	5149404070	2-1102570-7	120	5168696400	4-1106204-5	185	9043001951	6-1105250-1	40
5142543200	2-1102360-2	164	5149406471	2-1103344-7	145	5168906471	2-1102622-5	150	9043001955	4-1105251-1	40
5142600679	2-1102249-2	74	5149422470	2-1102496-7	92	5168906471	2-1102622-5	150	9043001956	5-1105251-1	40
5142600695	2-1102251-2	74	5149424070	2-1102564-7	120	5168906472	2-1102623-5	150	9043001957	6-1105251-1	40
5142601079	2-1102274-1	88	5149424071	2-1102567-7	120	5168906472	2-1102623-5	150	9043002220	2-1105250-1	40
5142601095	2-1102276-1	88	5149426471	2-1103338-7	144	5169300367	4-1102700-5	53	9043002221	2-1105251-1	40
5142601680	2-1102299-1	116	5149601680	2-1102472-2	75	5169301669	4-1102706-5	79	9043002222	3-1105250-1	40
5142601696	2-1102301-1	116	5149601696	2-1102474-2	75	5169302470	4-1102715-5	98	9043002223	3-1105251-1	40
5142602480	2-1102331-1	141	5149602480	2-1102507-1	88	5169304071	4-1102725-5	125	9043002286	1-1105250-1	40
5142602496	2-1102333-1	141	5149602481	2-1102511-1	88	5169321669	4-1102704-5	79	9043002287	1-1105251-1	40
5142603281	2-1102354-1	161	5149602496	2-1102509-1	88	5169322470	4-1102714-5	98	904900838	0-1108741-3	184
5142603297	2-1102356-1	161	5149604080	2-1102575-1	116	5169324071	4-1102723-5	125	9049001724	1-1102411-6	139
5142611079	2-1102286-6	91	5149604081	2-1102579-1	116	5169326471	4-1102755-5	150	9049001788	1-1102414-6	140
5142611680	2-1102308-6	119	5149604096	2-1102577-1	116	5169500300	4-1102703-5	53	9068		

Ihre Notizen/Your comments:

Ihre Notizen/Your comments:

Ihre Notizen/Your comments:

Ihre Notizen/Your comments:

Ihre Notizen/*Your comments:*

FOR MORE INFORMATION

te.com/products/HTS

TE Technical Support Center

Internet:	te.com/help
USA:	+1 (800) 522-6752
Canada:	+1 (905) 475-6222
Mexico	+52 (0) 55-1106-0800
Latin/S. America:	+54 (0) 11-4733-2200
Germany:	+49 (0) 6251-133-1999
UK:	+44 (0) 800-267666
France:	+33 (0) 1-3420-8686
Netherlands:	+31 (0) 73-6246-999
China:	+86 (0) 400-820-6015

Part numbers in this brochure are RoHS Compliant*, unless marked otherwise.

*as defined www.te.com/leadfree

te.com

© 2011 Tyco Electronics Corporation, a TE Connectivity Ltd. Company. All Rights Reserved.

889745-2 CIS WR 08/2011

AMP, HTS, TE Connectivity and the TE connectivity (logo) are trademarks.

Other logos, product and Company names mentioned herein may be trademarks of their respective owners.

While TE has made every reasonable effort to ensure the accuracy of the information in this catalog, TE does not guarantee that it is error-free, nor does TE make any other representation, warranty or guarantee that the information is accurate, correct, reliable or current. TE reserves the right to make any adjustments to the information contained herein at any time without notice. TE expressly disclaims all implied warranties regarding the information contained herein, including, but not limited to, any implied warranties of merchantability or fitness for a particular purpose. The dimensions in this catalog are for reference purposes only and are subject to change without notice. Specifications are subject to change without notice. Consult TE for the latest dimensions and design specifications.

